

**Rec Recording
Elta Electronic Tacheometer**

SURVEYORS-EXPRESS™

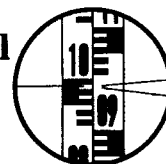

**Milanweg 53 • 61118 Bad Vilbel
Tel. 06101 / 54 13 54 • Fax 55
www.vermessen.de**



 **Geodesical**

Contents:

Introduction

1. Instrument Description

- 1.1 Survey 1 - 1
- 1.2 Rec Elta controls 1 - 3
- 1.3 Operation and control 1 - 7
 - 1.3.1 Turning on and off 1 - 7
 - 1.3.2 Measurement initiation 1 - 7
 - 1.3.3 Rec E keyboard 1 - 7
 - 1.3.4 Soft keys 1 - 9
- 1.4 Rec Elta components 1 - 10
 - 1.4.1 Compensator 1 - 10
 - 1.4.2 Audible signal generator 1 - 11
 - 1.4.3 Memory 1 - 11
 - 1.4.4 Interface 1 - 12
 - 1.4.5 Temperature and atmospheric pressure acquisition 1 - 13
 - 1.4.6 Battery 1 - 14

2. Program Execution

- 2.1 User guidance 2 - 1
- 2.2 Short cuts 2 - 1
- 2.3 Main menu and program levels 2 - 3
- 2.4 Menu types 2 - 6

3. Measurement Procedure

- 3.1 Requirements 3 - 1
- 3.2 Turn-on routine 3 - 1
- 3.3 Main menu 3 - 5
- 3.4 Measurement 3 - 6

4. Actions before Instrument Use

- 4.1 Project data 4 - 1
- 4.2 Input 4 - 2
- 4.3 Adjustment 4 - 2
- 4.4 Units 4 - 3

- 4.5 Set 4 - 3
- 4.6 Switches 4 - 4

- 5. Project Data 5 - 1

- 6. Input 6 - 1

- 7. Adjustment
 - 7.1 Survey 7 - 1
 - 7.2 V index 7 - 3
 - 7.3 EDM signal 7 - 6
 - 7.4 Clock 7 - 8
 - 7.5 HZ collimation 7 - 10
 - 7.6 Compensator 7 - 13
 - 7.7 Display 7 - 17

- 8. Common Features of the MEASURE, SPECIAL and COORDINATES Programs
 - 8.1 Program call 8 - 1
 - 8.2 Mode activation 8 - 2
 - 8.2.1 Soft key description 8 - 2
 - 8.3 Input and measurement menu 8 - 5
 - 8.3.1 Display description 8 - 5
 - 8.3.2 P.I. input 8 - 5
 - 8.3.3 Result 8 - 6
 - 8.3.4 Marks 8 - 6
 - 8.3.5 Function keys and soft keys 8 - 7

- 9. MEASURE Program
 - 9.1 Survey 9 - 1
 - 9.2 D-Hz-V 9 - 3
 - 9.3 E-Hz-V 9 - 5
 - 9.4 E-Hz-H 9 - 7
 - 9.5 Hz-V 9 - 10
 - 9.6 E-Hz-V Tracking 9 - 12
 - 9.7 Set Hz 9 - 15

10. Special Program

- 10.1 Survey 10 - 1
- 10.2 Connecting distances 10 - 6
- 10.3 Object height 10 - 11
- 10.4 Point-to-line distance 10 - 14
- 10.5 Vertical plane 10 - 20

11. Coordinates Program

- 11.1 Survey 11 - 1
- 11.2 Stationing on known point 11 - 3
- 11.3 Elevation stationing 11 - 11
- 11.4 Setting out 11 - 15
- 11.5 Free stationing 11 - 20
- 11.6 Side shots 11 - 25

12. Units 12 - 1**13. Set**

- 13.1 Survey 13 - 1
- 13.2 Marking 13 - 3
 - 13.2.1 Defining your own marks 13 - 4
 - 13.2.2 Mark transfer from the Rec Elta to the Mem 13 - 10
 - 13.2.3 Mark transfer from the Mem to the Rec Elta 13 - 11
- 13.3 Decimal digits 13 - 12
- 13.4 Password 13 - 14
- 13.5 Project prompts 13 - 16
- 13.6 PC-Demo 13 - 18

14. Switches 14 - 1**15. Editor Program**

- 15.1 Survey 15 - 1
- 15.2 Record display 15 - 2
- 15.3 Record retrieval 15 - 3
- 15.4 Additional Code 15 - 5
- 15.5 Coordinate records entry 15 - 7
- 15.6 Record editing 15 - 9
- 15.7 Record deletion 15 - 10

16. Transfer Program

- 16.1 Survey 16 - 1
- 16.2 Interface selection 16 - 2
- 16.3 Parameter setting 16 - 5
- 16.4 Update 16 - 7
- 16.5 REC E off 16 - 8
- 16.6 GT Dos Disk Drive 16 - 9

17. Dac E

- 17.1 Description 17 - 1
- 17.2 Startup 17 - 2
 - 17.2.1 Power connection 17 - 2
 - 17.2.2 Connection of peripheral devices 17 - 2
 - 17.2.3 Turning on and off 17 - 3
- 17.3 Main menu 17 - 4
- 17.4 Differences from the Rec E 17 - 4
 - 17.4.1 Keyboard 17 - 4
 - 17.4.2 Data transfer 17 - 4
 - 17.4.3 Display 17 - 5
 - 17.4.4 Audible signal 17 - 5

18. Mem E Memory

- 18.1 Features 18 - 1
- 18.2 The application-oriented memory concept 18 - 1

19. Interface Description

- 19.1 What is an interface 19 - 1
 - 19.1.1 Hardware interfaces 19 - 1
 - 19.1.2 Software interfaces 19 - 1
 - 19.1.3 User interfaces 19 - 1
- 19.2 The hardware interfaces in the Rec Elta 19 - 2
 - 19.2.1 Rec E <-> Elta 19 - 2
 - 19.2.2 Rec E <-> Mem E 19 - 2
 - 19.2.3 Rec E <-> periphery 19 - 2
- 19.3 Connectors 19 - 4
 - 19.3.1 8-point interface connector at the Rec E/Dac E 19 - 4
 - 19.3.2 25-point interface connector at the Dac E 19 - 5
 - 19.3.3 Cables 19 - 5

- 19.4 Transfer parameters and protocols 19 - 6**
 - 19.4.1 Optional transfer parameters 19 - 6**
 - 19.4.2 Default parameters 19 - 7**
 - 19.4.3 Protocol timing diagrams 19 - 7**
 - 19.4.3.1 Rec 500 software dialog 19 - 8**
 - 19.4.3.2 REC 500 + line control (modem lines) 19 - 9**
 - 19.4.3.3 LN-CTL (line control) 19 - 10**
 - 19.4.3.4 LN-CTL + end byte 19 - 11**
 - 19.4.3.5 XON/XOFF 19 - 11**
 - 19.4.3.6 XON/XOFF + end byte 19 - 11**
- 19.5 Record formats 19 - 12**
 - 19.5.1 The Rec 500 record format 19 - 12**
 - 19.5.1.1 Format 19 - 12**
 - 19.5.1.2 List of all records 19 - 13**
 - 19.5.1.3 List of all type codes 19 - 20**
 - 19.5.1.4 The Rec 500 format and the Rec Elta 19 - 22**
 - 19.5.2 The REC 200 record format 19 - 23**
 - 19.5.2.1 Format 19 - 23**
 - 19.5.2.2 The Rec 200 format and the Rec Elta 19 - 24**
- 19.6 Record conversion 19 - 25**
 - 19.6.1 New record format 19 - 25**
 - 19.6.1.1 Data transfer in the Rec 500 record format 19 - 26**
 - 19.6.1.2 Data transfer in the Rec 200 record format 19 - 27**
 - 19.6.2 Old record format 19 - 28**
 - 19.6.2.1 Writing to a Mem E with the old format 19 - 29**
 - 19.6.2.2 Reading a Mem E with the old format 19 - 31**
- 19.7 Data transfer programs from Carl Zeiss 19 - 33**
- 19.8 Linkage to office software 19 - 33**

Appendix

A 1 Formulae A - 1

- A 1.1 Correction and computing formulae for angle measurement A - 1
- A 1.2 Basic formulae for distance measurement A - 1
- A 1.3 Distance computation and reduction in the Rec Elta A - 2
- A 1.4 Rec Elta check on calibrated distances A - 4
- A 1.5 Prism and addition constants A - 5

A 2 List of Soft Keys A - 6

- A 2.1 Alphabetic list A - 7
- A 2.2 Assignment to the application programs A - 10

A 3 Technical data A - 13

- A 3.1 Elta 2 and 3 A - 13
- A 3.2 Elta 4 and 5 A - 15
- A 3.3 Rec E A - 17

A 4 Error Messages A - 18

- A 4.1 Elta error messages A - 18
- A 4.2 Rec error messages A - 19

A 5 Measurement preparation A - 20

- A 5.1 Transport A - 20
- A 5.2 Instrument setup A - 20
- A 5.3 Telescope adjustment and sighting A - 21

A 6 Power Supply A - 22

A 7 Adjustment A - 23

- A 7.1 Collimation error elimination A - 23
- A 7.2 Alidade level adjustment A - 23
- A 7.3 Optical plummet adjustment A - 24
- A 7.4 Level adjustment at accessories A - 25

A 8 Accessories A - 26

- A 8.1 Description A - 26
- A 8.2 Catalog numbers A - 28

Introduction

This manual describes the use of the Rec Elta Recording Electronic Tacheometer from Carl Zeiss. It covers both the Rec Elta 2 and 3 with two-axis compensator and the Rec Elta 4 and 5 with one-axis compensator.

While chapter 1 describes the individual hardware components of the Rec Elta, chapter 2 explains the program structure to facilitate understanding.

Chapter 3 surveys the measurement procedure for fast familiarization with the system.

Actions required before instrument use, such as selecting the units to be used for measurement or setting switches and determining the instrument errors are described in chapter 4. A detailed description is given in chapters 5 to 7 and 12 to 14.

The menus and keys required for both the measuring and computing programs are described in chapter 8.

The measuring and computing programs are described in detail in chapters 9 to 11.

Chapter 15 describes the editor functions for searching, displaying, editing and deleting the recorded data.

Chapter 16 deals with data transfer from the Rec Elta to peripheral devices and vice-versa.

Detailed information on the Dac E, the Mem E memory and the interface is given in chapters 17 to 19.

The Appendices might clarify relationships by means of surveys, tables and formulae. General information on instrument use, care and maintenance and adjustment supplement the information in the Appendix.

The salient features of the Rec Elta - the measuring head Elta and the recording and computing unit Rec E are:

Elta:

- Incremental electronic scanning of the horizontal and vertical circles (diametrical scanning of the Rec Elta 2)
- Electro-optical rangefinder in the infrared region using the phase comparison method
- Compensator for correcting the vertical axis tilt
- Automatic temperature and atmospheric pressure acquisition
- Audible signal generator
- Three-key keyboard at the Elta for turning on and off
- Liquid crystal display (LCD)

Rec E:

- 24 single-function keys at the Rec E, color coding of the key groups, alphanumeric input, variable soft keys with additional functions
- Graphics display (240x38 pixels) with 4 lines with 40 characters each, automatic contrast control and a wide viewing angle
- Convenient user interface with menu and interactive modes (display and keyboard assignment)
- Direct selection of important program parts regardless of the current program level
- Application-oriented programs
- Interchangeable Mem E memory (non-volatile memory) with a capacity of approx. 2000 records
- RS 232 C (V.24) interface for data input and output

This instrument was produced with tested methods and quality materials. The mechanical, optical and electronic functions were checked thoroughly before delivery. Should any defect attributable to faulty materials or workmanship occur within the warranty period, it will be recovered as a warranty service.

This warranty does not cover defects attributable to operator errors or improper handling.

Any further liabilities, e.g. for indirect damage, cannot be assumed.

Subject to change without prior notice for further development.

Manufacturer:

Carl Zeiss
Postfach 1369/1380
D-7082 Oberkochen
Germany
Telephone (07364) 201
Telegrams: zeisswerk oberkochen
Telex 07 1375 155
Telefax (07364) 20 2376

The logo for Geodesical, featuring the word "Geodesical" in a light blue, sans-serif font. A stylized blue orbital ring or path curves around the letter "G".

 **Geodesical**

1. Instrument Description

1.1 Survey

$$\text{Rec Elta} = \text{Elta} + \text{Rec E}$$

Elta (electronic tacheometer):

Measurement sensor:

- Compensator sensing
- Measurement (D, HZ, V)
- Measured data correction for:
vertical axis tilt,
meteorological conditions etc.

Rec E (operating, computing and recording unit):

- Program control
- Receives the measured data from the Elta
- Data editing and computation
- Recording in the Mem

Elta display (6):

- Displays the original measured data
- Displays tracking functions

Rec E display (14):

- Four lines with 40 characters each
- Graphics capability (240 x 38 pixels)
- Menu selection
- Dialog information
- Displays measured and/or computed data and point identifications

Elta keyboard (31):

- For turning the instrument on and off
- Measurement initiation

Rec keyboard (16):**Hard keys (see 1.3 (3)):**

- 24 single-function keys, color coding of key groups,
- Operation and control of program execution
- Input and editing of values and parameters, selection of functions and programs
- Alphanumeric input

Function keys (soft keys) (see 1.3 (4)):

- Functions which depend on the selected program
- Display in the bottom line

Recording:

- Interchangeable Mem E memory (29) with a capacity of approx. 2000 records
- Non-volatile memory without buffer battery
- Data retention time at least 1 year

Power supply:

- NiCd battery pack (5) with 4.8 V and 1.8 Ah for about 8 hours of operation

Sensors (23):

- Automatic measurement of temperature and atmospheric pressure
- Sensors can be disabled to allow manual entry

Audible signal generator (15):

- Supports specific functions by audible signals

1.2 Rec Elta Controls

- | | | | |
|----|------------------------------|----|----------------------------------|
| 1 | Handle | 2 | Handle screws |
| 3 | Battery cartridge screw | 4 | Rangefinder adjustment screws |
| 5 | Battery cartridge | 6 | Display window with illumination |
| 7 | Focussing | 8 | Ring cap over reticle adjustment |
| 9 | Eyepiece with diopters scale | 10 | Eyepiece mount |
| 11 | Sighting collimator | 12 | Alidade level |
| 13 | Main menu table | 14 | Display |
| 15 | Audible signal generator | 16 | Keyboard |
| 17 | R S232 C interface | 18 | Tribrach |
| 19 | Tribrach screw | 30 | Tribrach attachment screw |
| | | 32 | Tripod joint |

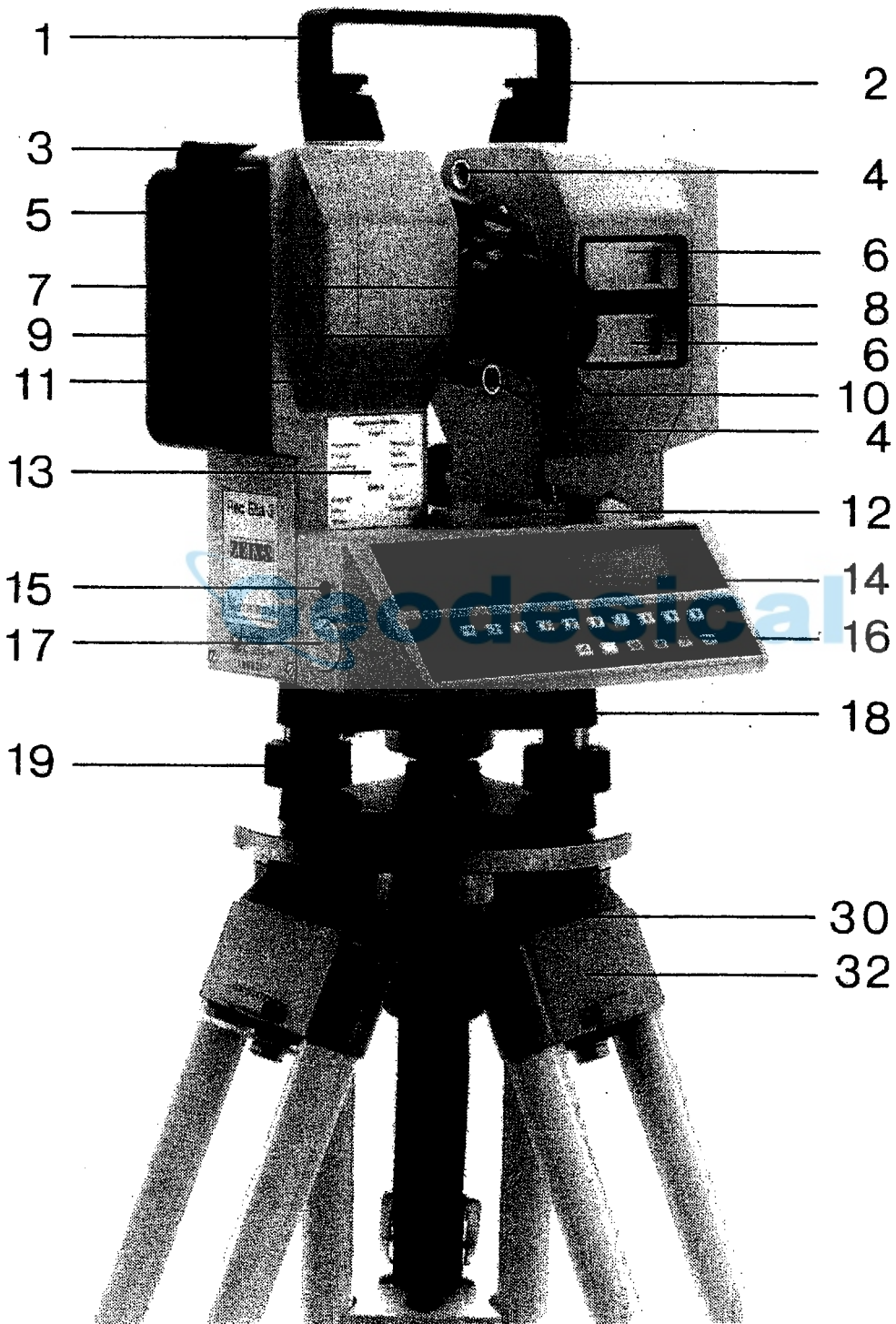

Fig. 1.2.1: Rec Elta main operation side

21	Tilting axis height mark	20	Sun shade
23	Temperature and pressure sensor	22	Optical plummet
25	Vertical fine motion	24	Horizontal fine motion
27	Vertical clamp	26	Horizontal clamp
29	Mem module with Mem	28	Spigot clamp
31	Keyboard for turning on and off		
33	Tribrach circular level	34	Counter weight

The logo for Geodesical, featuring the word "Geodesical" in a light blue, sans-serif font. A stylized, light blue orbital ring or path surrounds the letter "G".

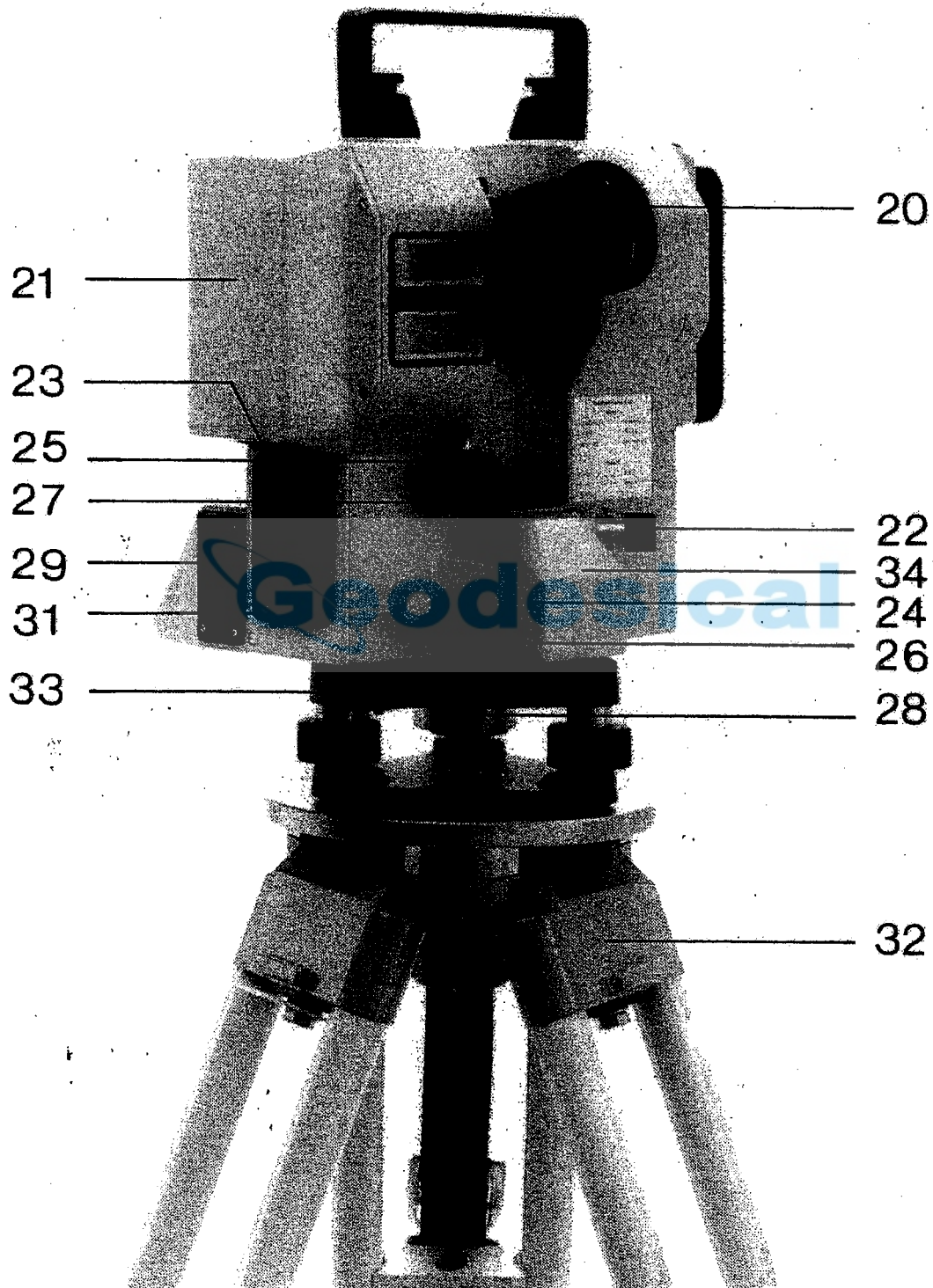

Fig. 1.2.2: Rec Elta rear

1.3 Operation and Control

1.3.1 Turning on and off

The Rec Elta can be turned on and off with the 3-key keyboard at the Elta.

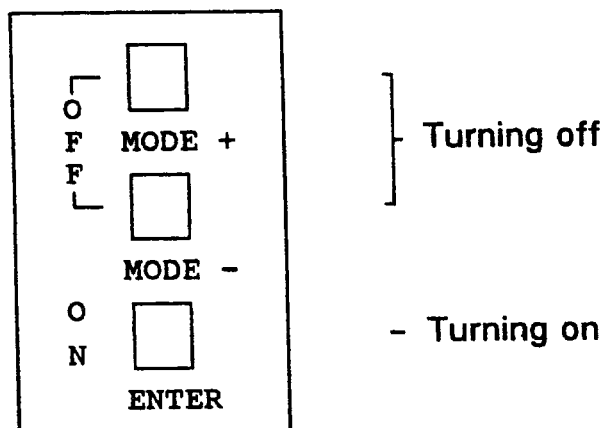

Fig. 1.3.1.1: Turning on and off

1.3.2 Measurement initiation

- ENTER key at the Elta (31) or
- ENT key at the Rec E keyboard

1.3.3 Rec E keyboard (hard keys)

Key survey by functions:

Light grey:

- Numeric keys 1,...,0
- +/- key
- Spacebar

Medium grey:

- Vertical cursor keys \uparrow, \downarrow
- Horizontal cursor keys \rightarrow, \leftarrow

Dark grey:

- Function keys TAB, FCT, INP, LEV, MEM, ABC, MEN and ENT

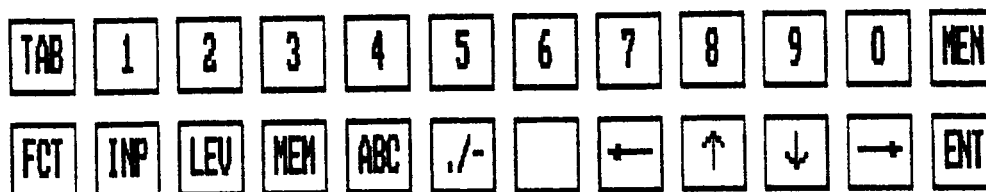

Fig 1.3.3.1: Rec E keyboard

Key	Function	Usage
1, ..., 0	Numeric keys	<ul style="list-style-type: none"> - Number entry in the Rec E - Soft key selection (together with FCT key) - Program selection
·/-	Minus sign (direct access)	<ul style="list-style-type: none"> - Sign for negative input - Special character, e.g. for point identification input
	Decimal point (with FCT key)	<ul style="list-style-type: none"> - Special character, e.g. for point identification input - For numeric input, the decimal point is set forcibly and cannot be changed
	Spacebar	<ul style="list-style-type: none"> - For space input
ABC	Alpha key	<ul style="list-style-type: none"> - Function key for activating alphabetic and special characters input
FCT	Function key	<ul style="list-style-type: none"> - Selection of soft keys together with numeric keys 1, ..., 0. - Shift key for entering capitals
TAB	Tab function	<ul style="list-style-type: none"> - Supports point identification (P.I.) input
▲, ▼, ►, ◄	Cursor functions	<ul style="list-style-type: none"> - Selection of the entry or editing position - Editing and incrementing or decrementing values - Scrolling in lists - Change of input field
MEN	MENU function (ESCAPE)	<ul style="list-style-type: none"> - Exit from a function to the next higher menu - Return from a subroutine to the calling program
ENT	ENTER function	<ul style="list-style-type: none"> - Continues program execution (see display) - Measurement initiation <p>The ENTER key at the Elta (31) is also active</p>
INP	Input menu	<ul style="list-style-type: none"> - Direct input menu access from a function and later return to the calling point - see also INPUT program (chapter 6)
MEM	Memory load	<ul style="list-style-type: none"> - Display of the current Mem load and return to the calling point

- LEV** Vertical axis tilts - Display of the components of the vertical axis
- Levelling correction without center point determination (RecElta 2 and 3) see "Compensator" mode in the ADJUST program (chapter 7)

Repeat function: Keys 1, ..., 0, TAB, the spacebar and the cursor keys if pressed continuously.

Normal function: All other keys.

1.3.4 Soft keys

Soft keys are function keys that are assigned different functions in the different programs. The current functions are displayed in the bottom display line using mnemonics up to 3 characters long.

There are two types of soft keys:

- Some initiate functions and return to the calling program part (e.g. Inf = input of an information record)
- Others display a switch setting and allow its modification (e.g. incrementing on or off)

Soft key selection:

- Press the FCT key and the numeric key below the soft key to be selected
- If soft key 0 shows →2, further functions can be activated on line 2.

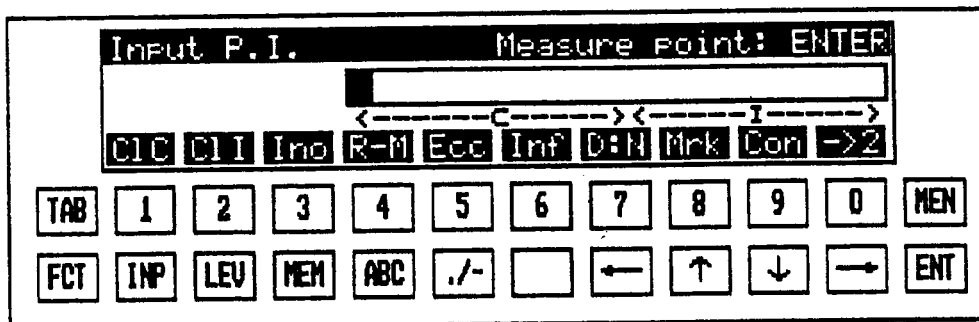

Fig. 1.3.4.1: Soft keys

1.4 Rec Elta Components

1.4.1 Compensator

(1) Purpose

Determination of the current vertical axis tilts in the sighting and tilting axis directions by a two-axis liquid compensator (in the Rec Elta 2 and 3); in the Rec Elta 4 and 5 a one-axis compensator determines the tilt in the line of sight direction.

(2) Function

The effects of the vertical axis tilt on the horizontal and vertical circle readings are corrected automatically (in the Rec Elta 4 and 5 vertical circle correction only).

The levelling of the Rec Elta can be checked by means of the digital display of the tilts (see 7.5).

(3) Operating range

The operating range of the compensator in both directions is $\pm 2'40''$ or 48 mgrads.

If the compensator is out of range, the decimals of the distance and angle displays in the Elta display are replaced by dashes (also during fast instrument rotation).

281.-----
100.-----

(4) Check

Periodical compensator checking is required for precise operation. Checking is by center-point determination in the COMPENSATOR mode of the ADJUST program (see 7.5).

This check is required for precise height measurement.

(5) Display

Vertical axis tilt display with function key LEV.

(6) Turning on and off the compensation:f

- Setting of the default ON or OFF in the SWITCHES program (see 14)
- Change in any measurement program with soft key Kon/Kno

1.4.2 Audible signal generator

(1) Purpose

Rec Elta function confirmation by an audible signal.

(2) Function

Confirmation by a short signal:

- of any key stroke
- after successful initialization (zero-pulse capture)
- after measurement termination
- During recording: The recording of every data line is answered by a short audible sign.

A long beep sounds if an operating error occurs or the zero pulse is not captured.

(3) Turning on and off

The audible signal can be enabled and disabled in the SWITCHES program (see 14).

1.4.3 Memory

The logo for Geodesical, featuring the word "Geodesical" in a light blue, sans-serif font. A stylized blue orbital path or ring surrounds the letter "G".

The non-volatile memory of the Rec Elta contains computing constants, operating conditions, measuring units etc. also when the Rec Elta is turned off.

Data and additional information is stored in the interchangeable Mem E memory (see 18, MEM E Memory).

(1) Purpose

- Storage of measured and/or computed data
- Storage of the whole measurement procedure

(2) Data retention time

The data stored in the interchangeable Mem E memory (non-volatile memory without buffer battery) is safe for at least one year.

(3) Capacity

The capacity of the Mem E depends on the mode and the kind and

amount of data. It is approx. 2000 data records.

(4) Storage method

All records are stored with their consecutive numbers (address) and can be retrieved with this address or with the point number or the point identification.

Every record consists of an alphanumeric point identification with up to 27 characters and up to three measured or computed values and the associated type codes.

1.4.4 Interface

(1) Purpose

The RS 232 C interface enables transfer of the data measured and/or computed in the field and recorded in the Mem E to peripheral devices, or transfer of data from peripheral devices to the Mem E (bidirectional data transfer, see 16. and 19.).

(2) Options

- Online transfer over the RS 232 C interface of the Rec Elta to peripheral devices
- Data transfer to peripheral devices with the Mem E over the RS 232 C interface of the Dac E data converter
The Dac E functions correspond to those of the Rec E
- Users whose data flow is based on the precursor models Elta 2
- Mem 800 - Dac 100 can use the data with a DAC 100 adapter (see A 8.2 (9)) for the Mem E.

1.4.5 Temperature and atmospheric pressure acquisition

(1) Purpose

Atmospheric correction of the electro-optically measured distance for temperature and atmospheric pressure.

(2) Requirement

In a standard atmosphere with 20° C air temperature and 944 hPa air pressure, atmospheric errors in distance measurement will reduce to zero. If the temperature or pressure deviate from these values when the measurement is made, the current temperature and atmospheric pressure data are required to deduce the correct distance. These may be entered manually or may be determined automatically using the sensors built into the Elta.

If the temperature and atmospheric pressure differ from the given values, an error results which acts as a scale factor, i.e. the error increases linearly in proportion to the distance.

A deviation in the temperature of 10°C or of 30 hPa in air pressure results in an error of 10 ppm. This is equivalent to a distance error of 1 mm in 100 m.

(3) Entry or automatic sensing

Manual entry of the temperature and atmospheric pressure or automatic determination by a sensor.

Automatic sensing or manual entry of the temperature and the atmospheric pressure can be selected in the SWITCHES program (see 14).

In the INPUT program (see 6), the inverted representation of the temperature and atmospheric pressure lines indicates automatic acquisition. If you selected manual entry, the display is normal.

The sensor for automatic temperature acquisition is integrated in the outer cabinet wall, but thermicly insulated. Nevertheless the instrument should be protected against large temperature variations and against sun radiation with a field screen.

1.4.6 Battery

(1) Operation time

The liquid crystal display of the Rec Elta draws very little power. A fully charged battery lasts for 6 to 8 hours of operation depending on the age and condition of the battery and on the type of measurement work.

The display window illumination in the Elta with LEDs reduces the operation time and should therefore be used sparingly. The illumination can be turned on and off in the SWITCHES program (see 14).

(2) Battery change

The "BATT" message appears in the Elta display and an audible signal consisting of three short beeps sounds when the battery is low to request a battery change without turning off the Rec Elta.

A built-in buffer battery buffers the standby mode during the battery change.

The battery change should be completed within one minute.

Proceed as follows:

BATT. AFTER
CHANGE ENTER

- Battery change: The initial display appears at the Rec (see Fig. 3.2.1)
- Press the ENTER key at the Elta; an audible signal sounds after a short time.
- The Rec E display changes to the main menu.

If changing the battery is not possible for some reason, press the ENTER key in the Elta to turn off the instrument and prevent buffer battery discharging.

The batteries supplied with the instruments contain an internal fuse protecting the instrument and the battery against shorts. These batteries can also be used with old instruments. The old batteries (Cat. No. 708151) may not be used with new instruments.

 **Geodesical**

 **Geodesical**

2. Program Execution

2.1 User Guidance

The Rec E guides the user through the programs with menus and by interactive means. The measurement and computation options and the required entries are displayed. You can select and enter the desired option.

- **Selection menus (see Fig. 2.3.1)**

Where there is a choice between several programs, modes or options, only the digit below the applicable mark (L) has to be pressed.

- **Soft key menus (see Fig. 2.3.4)**

Soft keys are function keys that are assigned different functions by different programs. The current functions are indicated in the bottom display line by abbreviations consisting of up to 3 characters.

This allows matching the measurement procedure to the application.

The functions can be called by simultaneously pressing the FCT key and the applicable numeric key.

- **Dialog lines and dialog fields**

The Rec Elta program gives you many hints on what has to be done or can be done. These hints are displayed in inverted form in a dialog line or a dialog field.

The 1st display line is generally used as dialog line (see Fig. 2.3.2 or 2.4.2).

The dialog fields are arranged at the right-hand side of the display (e. g. INPUT MENU).

- All entries are checked for plausibility where possible. Errored entries are rejected and must be repeated.

2.2 Short Cuts

Short cuts are provided between the programs and modes to speed up program execution. These short cuts avoid the long route through the different menus and the associated forced program exits.

A function in another program part can be accessed directly from the current program level. After function completion, the calling function is returned to.

Hard keys

INP:

- . Calls the INPUT menu for changing parameters such as the instrument and reflector heights, temperature, atmospheric pressure etc.
- . Return to the calling program part with MEN

LEV:

- . Displays the vertical axis tilts for correcting the levelling
- . Return to the calling program part with MEN

MEM:

- . Displays the current memory load
- . Return to the calling program part with MEN

MEN:

- . Exit from a program, mode or function to the next higher menu
- . Return from a utility routine (e.g. soft key) to the calling program

Soft keys

The logo for 'Geodesical' features the word in a light blue, sans-serif font. A stylized blue arc or swoosh is positioned above the 'G' and extends under the 'e' and 's'.

- | | |
|------|--|
| Com: | Compensator center-point determination |
| Ind: | Index correction determination |
| Col: | Collimation correction determination |
| Inp: | Input of coordinate records in the application program |

Switches

Some soft keys serve as switches in all modes. The switch condition is displayed and can be changed with the soft key:

- | | |
|---------------------|--|
| Ino, Ion: | Incrementing mode |
| Rno, R-M, R-C, RMC: | Recording mode |
| Kon, Kno: | Compensation mode |
| D:N, D:L, D:R: | Distance measurement method |
| DTh, Th: | Toggling between D-Hz-V or E-Hz-V and Hz-V |

2.3 Main Menu and Program Levels

The tree structure of the programs and the short cuts with the function keys afford clear program control.

The top level of the Rec E user interface is the main menu with the 11 programs that can be called directly with numeric keys.

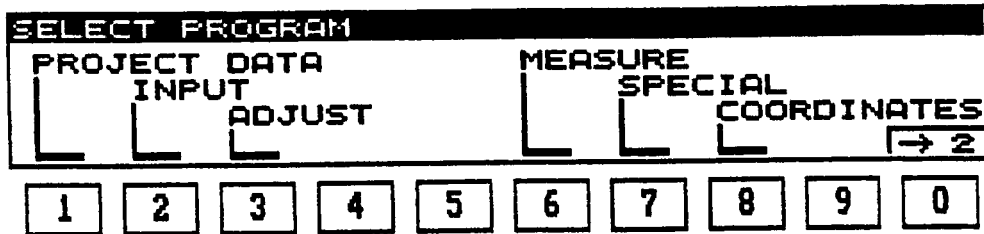

Fig. 2.3.1: Main menu - page 1 -

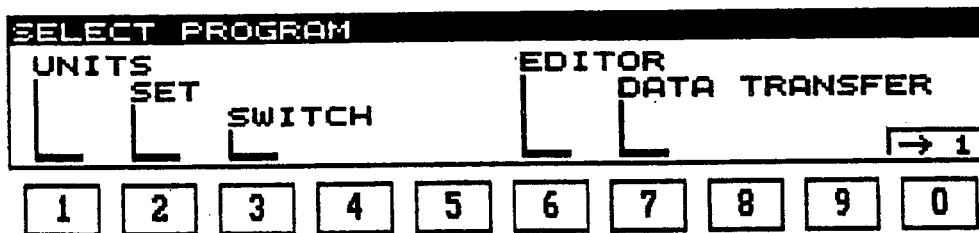

Fig. 2.3.2: Main menu - page 2 -

Survey of the programs and the associated keys

1. Programs on page 1 of the main menu:

Key	Function	Function
1	Project data	Information on the project
2	Input	Entry of parameters for correcting and reducing measurements
3	Adjust	Determination and checking of instrument parameters
6	Measure	Measurement of directions and distances
7	Special	Programs for special applications
8	Coordinates	Stationing, measurement, computation and setting-out of coordinates
0	Page change	Change from page 1 to page 2 of the main menu and vice-versa

2. Programs on page 2 of the main menu:

Key		Function
1	Units	Entry of units (m, ft, DMS, grads, °C, °F etc.)
2	Set	Setting of parameters (e.g. marks)
3	Switches	Setting of specific conditions (on or off)
6	Editor	Display and editing of the recorded data
7	Data transfer	Data transfer
0	Page change	Change from page 2 to page 1 of the main menu and vice-versa

In the ADJUST, MEASURE, SPECIAL, COORDINATES, SET and TRANSFER programs there are submenus from which a series of modes or functions can be called, for example the D-HZ-V mode in the MEASURE program.

These modes form the middle level of the user interface.

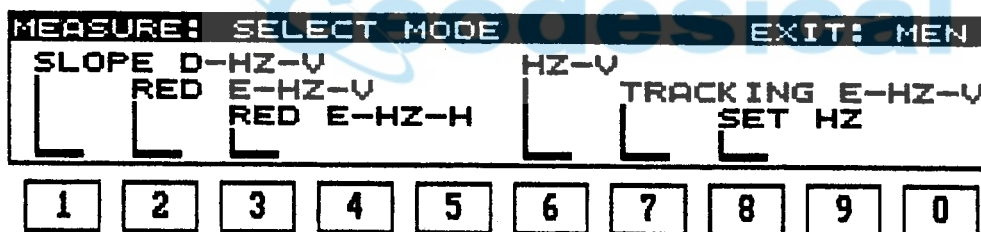

Fig. 2.3.3: Middle program level: MEASURE program with modes

Within these subprograms, the soft keys (function keys) allow calling a large number of different utility routines that serve to match program execution to your requirements.

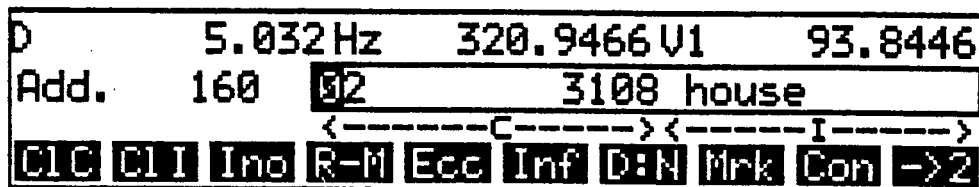

Fig. 2.3.4: Lower program level: D-HZ-V result menu with soft keys

From the modes, functions and submenus you can always return to the next higher menu with the hard key "MEN" (menu) (normal and emergency exit).

The INPUT, UNITS and SWITCHES programs each consist of a table in which values can be entered directly or changed easily.

In the EDITOR program, the functions can be called directly with soft keys.

Soft keys and tables form the lower level of the Rec E user interface.

The logo for Geodesical, featuring the word "Geodesical" in a light blue, sans-serif font. A stylized blue ring or orbit surrounds the letter "G".

2.4 Menu Types

The sequence for calling menus and their structure are nearly identical and repetitive.

When you call a measurement mode, the initial menu appears first so that you can check the instrument condition with specific soft keys (Fig. 2.4.1).

scr

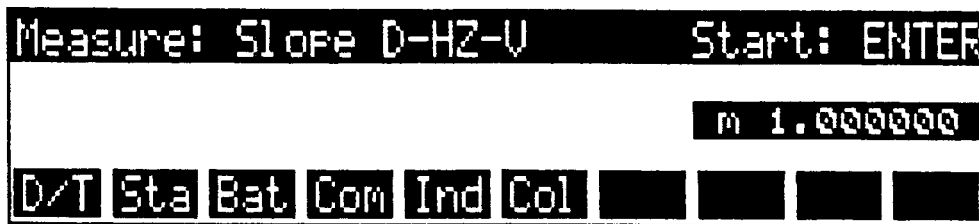

Fig. 2.4.1: Initial menu

In the following input and measurement menu (Fig. 4.2.2), a request appears to enter the point identification and to initiate measurement.



Fig. 2.4.2: Input and measurement menu

After measurement completion, the result is displayed in the result menu (Fig. 2.4.3).

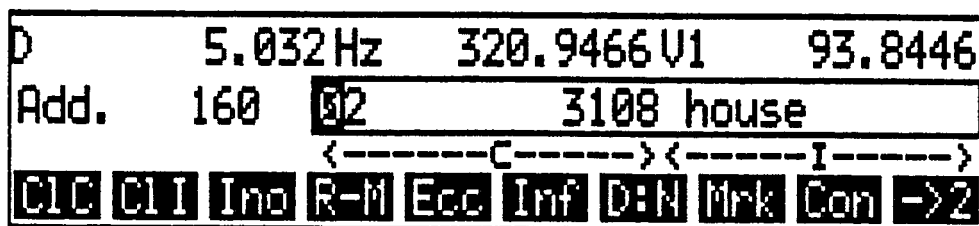

Fig. 2.4.3: Result menu

 **Geodesical**

The logo features a light blue, three-dimensional ring or sphere that is tilted and partially transparent, allowing the text behind it to be visible.

Geodesical

3. Measurement Procedure

3.1 Requirements

- Instrument installation
Levelling, centering, telescope adjustment
(see Appendix A 5, Measurement Preparation).
- Selection of the required measuring units and reference systems - e.g. meters, grads, zenith - (see 12., UNITS).
- Setting of the desired switches - e.g. automatic temperature and atmospheric pressure sensing on or off (see 14., SWITCHES).

3.2 Turn-on Routine

(1) Turning on the instrument:

Press the ENTER key (31) at the Elta.

- Display test in the Elta display:

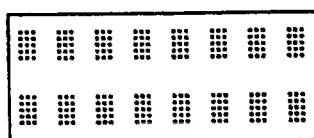

All characters appear simultaneously in the display.

Fig. 3.2.1: Display test

- The Rec display shows the program version and the copyright notice. This display remains visible during the whole startup routine.

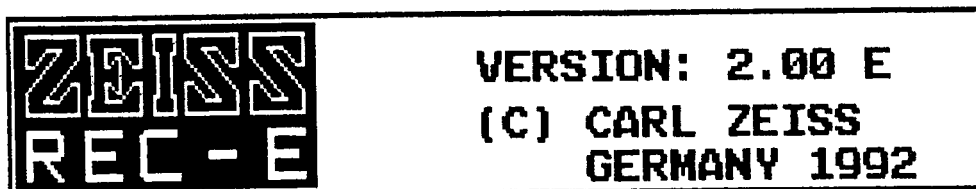

Fig. 3.2.2: Initial display in the Rec

- In parallel, the Elta display shows the following information successively (see also 12., UNITS):

Dist : N
METERS
GRAD
ZENITH

Display of the measurement method for distance measurement:

R = Rapid measurement, N = Normal measurement,
L = Measurement of long distances

Measuring units:

Distance measurement: meters/feet
Angle measurement: grads, DMS, DEG (dec.), mil,
Reference system for the vertical circle:
Zenith, vertical or height angle, % slope

S	1.000000
P	35
A	0.000

Display of

Current scale (S)
Prism constant (P)
Addition constant (A)

A	22
CELSIUS	
A	944
hPa/mb	

Display of the measuring units for temperature and atmospheric pressure and the current values (A = Automatic sensing of temperature and pressure, M = Manual input)

Temperature: °C or °F
Pressure: hPa or mb; Torr; InMerc

Fig. 3.2.3:
Elta information displays

(2) V circle initialization

Request to initialize (determine the zero point of the vertical circle) by audible signal and change to Fig. 3.2.4.

Important:

Initialization is possible only in position 1 (3-key keyboard (31) right).

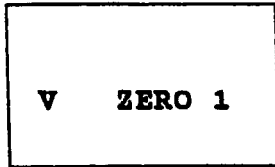

- Swing the telescope up and down smoothly.
- Successful initialization is confirmed by an audible signal; the display changes to "Zero 2"
- The 2nd zero pulse can be captured by another tilting direction change

Fig. 3.2.4:
V circle initialization

- Rec Elta 2 and 3: Continue with (3) Initialization of the HZ circle
- Rec Elta 4 and 5: The Rec display changes to the main menu (3.3); the Elta now continuously displays horizontal and vertical angles.

(3) HZ circle initialization

Initialization is required to determine the zero point of the horizontal circle (Rec Elta 2 and 3). The circle orientation is retained after turning off and on again (quasi absolute orientation).

The Rec Elta 4 and 5 do not have a quasi-absolute zero point.

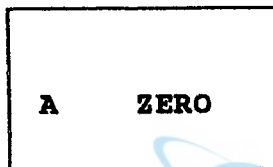

- Turn the instrument around the vertical axis.
- Successful initialization is confirmed by an audible signal.
- The Rec display changes to the main menu (3.3); the Elta now continuously displays horizontal and vertical angles.

Fig. 3.2.5:
HZ circle initialization

(4) Initialization error

An error message may appear if you tilt the telescope too fast, too slowly or not smoothly enough or rotate the instrument. Audible signals and remarks in the Elta display indicate this.



- Slower: Tilt more slowly
- Faster: Tilt faster
- Repeat: Insufficient tilting movement

Fig. 3.2.6:
Operator message

(5) Mem Check

- After initialisation the Rec program checks if a Mem is contained in the Rec.
An information is visible if the communication with the Mem isn't possible or if there isn't any Mem plugged in (Fig. 3.2.7).

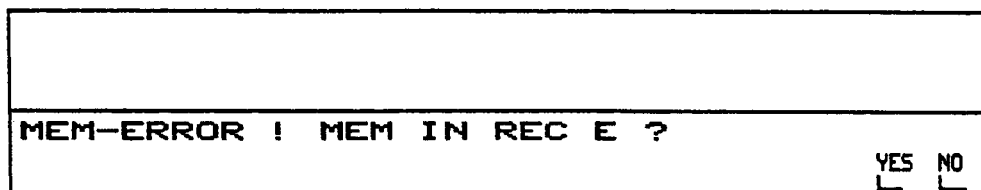

Fig. 3.2.7: Mem missing

- Measurement without recording in the Mem:
Press key 0 = No
All programs, modes and functions that access the Mem are blocked.
Change to the main menu (see 3.3).
The access to a Mem plugged in later can be activated again by pressing the key MEM.
- Measurement with recording in the Mem:
Insert the MEM and press key 9 = Yes
Change to the main menu (see 3.3).

(6) Turning off the instrument

To turn off the instrument, press the upper and center keys of the 3-key keyboard (31) simultaneously.

3.3 Main Menu

(1) Survey

Survey of the Rec Elta programs (on two pages).

Page 1: The most important measurement programs (always displayed first).

Page 2: Programs that are not used very often.

(2) Program selection

Press the numeric key below the "L" mark that points to the program.

(3) Page change

Key 0 below the mark →2 or →1.

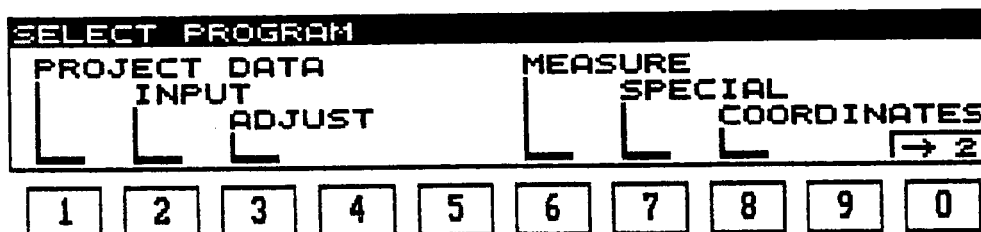

Fig. 3.3.1: Main menu - page 1 -

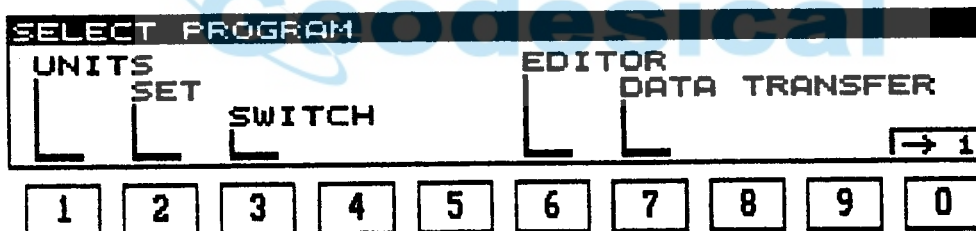

Fig. 3.3.2: Main menu - page 2 -

3.4 Measurement

(1) Program selection

Select the program with the appropriate numeric key - here key 6 for MEASURE (see Fig. 3.3.2).

(2) Mode selection

Select the mode (routines below the program level) with the appropriate numeric key - here key 1 for D-HZ-V.

MEASURE: SELECT MODE					EXIT: MEN				
SLOPE D-HZ-V			HZ-V		TRACKING E-HZ-V				
[]	RED	E-HZ-V	[]	[]	[]	[]	[]	[]	[]
[]	[]	RED E-HZ-H	[]	[]	[]	[]	[]	SET HZ	[]
[]	[]	[]	[]	[]	[]	[]	[]	[]	[]
1	2	3	4	5	6	7	8	9	0

Fig. 3.4.1: Modes of the MEASURE program

MEN: Return to the main menu

(3) Initial menu

Information on instrument parameters and correction values and their determination (e.g. index and collimation errors, scale, addition constant, temperature and atmospheric pressure) can be accessed directly with soft keys (FCT + numeric key) in the initial menu (Fig. 3.4.2) (see 9.1).

Measure: Slope D-HZ-V					Start: ENTER				
					m 1.000000				
D/T	Sta	Bat	Com	Ind	Col	[]	[]	[]	[]
1	2	3	4	5	6	7	8	9	0

Fig. 3.4.2: Initial menu of the D-HZ-V mode

ENT: Change to the input and measurement menu of the D-HZ-V mode

MEN: Return to the MEASURE program

(4) Input and measurement menu of the D-HZ-V mode

- Enter the point identification
- The format of the point identification corresponds to the selected mark
- selection with soft key Mrk (FCT + 8) - see also 13 SET).

Input P.I.		Measure Point: ENTER							
25		AE2904 street							
←-----C----->		←-----I----->							
K	L	M	N	O	P	Q	R	S	T
1	2	3	4	5	6	7	8	9	0

Fig. 3.4.3: Input and measurement menu of the D-HZ-V mode

- Select the position
Cursor keys → or ← or TAB key (tab stop setting in the SET program)
- Numeric input:
Press the desired numeric key
- Alphanumeric input:
When you press the ABC key, letters and special characters appear in the soft key line that are assigned to the numeric keys.
Letters line change: Down in the alphabet with ↓ and up with ↑.
Capitalization: FCT + numeric key assigned to the letter.
- Input editing
Go to the errored position with one of the two cursor keys → and ← and enter the correct digit; the errored digit is overwritten.

(5) Measurement procedure

- Sight the reflector - the intersection of the vertical and tilting axes of the reflector is defined by the intersection of the prism edges -
- Focus the target
- Initiate measurement with the
ENT key of the Rec or the
ENTER key of the 3-key keyboard (recommended for precise measurements or in position II - no unilateral pressure on the instrument)

- Received signal:
 - Is controlled automatically and the signal quality is indicated by the bar graph in the Elta display (see Fig. 3.4.4)
 - . Optimum: Bar graph is in the middle
 - . Measurement not possible: The measurement beam is interrupted or the signal amplitude is too low:
Bar graph left: termination possible with MEN
 - . Measurement not completed: Bar graph oscillates within the whole range

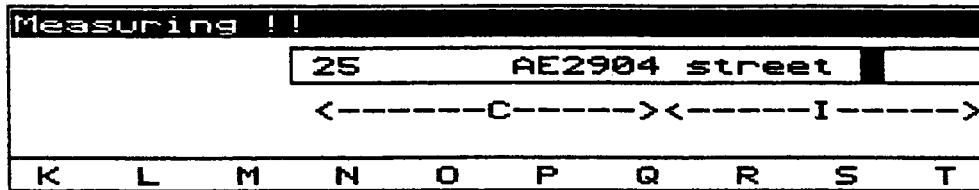

Fig. 3.4.4: Measure menu

- The measured values are corrected automatically before display for:
 - . the effect of temperature and pressure (distance D)
 - . the set prism or addition constant (D)
 - . the set scale (D)
 - . the index correction (vertical angle V)
 - . the collimation correction (horizontal angle Hz)
 - . the component of the vertical axis tilt in the sighting axis direction (Rec Elta 2, 3, 4, 5) (V)
 - . the component of the vertical axis tilt in the tilting axis direction (Rec Elta 2 and 3) (HZ)
 - . the circle eccentricities (Hz, V)
 - . the tilting axis error (Hz,V)

(6) Recording

The point identification and the measured values are automatically stored in a record after measurement completion.

Important:

The soft key for recording (FCT + 4) must be R-M, not Rno.

D	5.032 Hz	320.9466 V1	93.8442
Add.	163	25	AE2904 street
		<-----C----->	<-----I----->
CIC	CI	Ino	R-M
Ecc	Inf	D=N	Mrk
Con	->2		

Fig. 3.4.5: Result menu

(7) Further measurements

A new P.I. can now be entered (see (4)) in the result menu (Fig. 3.4.5), and another point measured (see (5)).

MEN: Exit from the mode.

Geodesical

 **Geodesical**

4. Actions before instrument use

Before using a new instrument for the first time or after an observer or project change, we recommend you check the instrument settings.

The different programs and modes and their default options are surveyed in the following. Detailed information is given in the mode descriptions further down in this manual.

The current values in the INPUT, UNITS and ADJUST programs can also be checked in the initial menu of each measurement mode with the soft key Grd (initial instrument condition).

4.1 Project Data

(1) Purpose

Input of project-related information. Input is optional.

```

PROJECT DESCR. LINE NO. 1
Project :  SELECT: ↑ ↓ ← →
                                     ENTER
  
```

Fig. 4.1.1: Project line 1

(2) Factory default settings

- | | |
|------------|------------|
| - Number 1 | Project |
| - Number 2 | Task No. |
| - Number 3 | Observer |
| - Number 4 | Reflector |
| - Number 5 | Instr. No. |
| - Number 6 | Date |
| - Number 7 | Remark |

A detailed description is given in 5., PROJECT DATA.

4.2 Input

(1) Purpose

Entry of parameters for the correction and reduction of measurements.

(2) Factory default settings

REFL:	1.500m	TEMP.:	23°C	INPUT MENU
INST:	1.650m	PRESS:	980hP	SELECT: ←↑↓→
ADCO:	0.000m	BAR.H:	456m	ENTER
SCLE:	1.000000	PPM :	0	

Fig. 4.2.1: Default settings

The atmospheric pressure and temperature (inverted display) are sensed automatically.

A detailed description is given in 6., INPUT.

4.3 Adjustment

(1) Purpose

Determination and check of the instrument error corrections.

ADJUST:	SELECT MODE	EXIT: MEN
V-INDEX	EDM-SIGNAL	HZ-COLLIMATION
┌	┌	┌
└	└	└
	CLOCK	COMPENSATOR
		DISPLAY
		┌
		└

Fig. 4.3.1: Adjustment options

Note:

The V index, the HZ collimation and the compensator should be adjusted before precision measurement.

A detailed description is given in 7., ADJUST.

4.4 Units

(1) Purpose

Specification of the measuring units.

(2) Factory default settings

ANGLE: GRD	V-REF : ZENITH	UNITS
DIST.: METER	HZ-REV: +	SELECT: ↑↑↓↓
TEMP.: C	PRESS : HPA/MB	ENTER
COORD: X Y Z		

Fig. 4.4.1: Default settings

A detailed description is given in 12., UNITS.

4.5 Set

In the SET program, individual entries can be made for the different modes.

(1) Marks mode:

Entry of your own symbols or formats for the 27-character point identification.

123456789012345678901234567	MARKING	1
<-----C-----><-----I----->	SELECT: ↑↓	
T P T	ENTER	

Fig. 4.5.1 Default mark

A detailed description is given in 13.2, Marking.

(2) Decimal places:

ANGLES (HZ,V) : 4	DEC. DIGITS
DISTANCES (D,E,H): 3	SELECT: ↑↑↓↓
	ENTER

Fig. 4.5.2: Defaults

(3) Password mode:

There is no default password.

If you enter a password, some modes are blocked and cannot be changed inadvertently.

(4) Project line mode see 4.1:

New defaults can be defined here.

Detailed information is given in 13., SET.

4.6 Switches**(1) Purpose**

Turning on and off different instrument functions.

(2) Factory default settings

The screenshot shows a grid of settings for various instrument functions. The settings are as follows:

COMPENSAT. : ON	RECORD. : ON	SWITCH
ILLUMINAT. : OFF	SOUND : ON	SELECT: ↑↑↓↓
AUTO(T/P) : ON		ENTER

Fig. 4.6.1: Defaults

A detailed description is given in 14., SWITCHES



 **Geodesical**

5. Project Data

(1) Purpose

Entry of project-related information. Input is optional.

(2) Program selection

Numeric key 1 of the main menu displays project line 1 (see Fig. 5.1).

Fig. 5.1: Project line 1

Project lines may be defined beforehand for support of the input. The following default project lines are set:

- | | | |
|------------|------------|---|
| - Number 1 | Project | : |
| - Number 2 | Task No. | : |
| - Number 3 | Observer | : |
| - Number 4 | Reflector | : |
| - Number 5 | Instr. No. | : |
| - Number 6 | Date | : |
| - Number 7 | Remark | : |

You can create your own project lines in the SET program (main menu, page 2) (see 13.5).

(3) Selection of individual project lines

Individual project lines can be selected with the cursor keys ↓ (down) and ▲ (up).

(4) Activating the input or change

Confirm proper selection with ENT (see Fig. 5.2).

Fig. 5.2: Input of project lines

Effective soft keys:

Soft key	Function
Cll	Cancel the information
Tme	Set the current time
Dat	Set the current date

There are 17 digits for project description available on every line. All 27 digits are available if the option "Project data with 27 digits" was selected in mode SETTING / PROJECT LINES.

(5) Input or editing termination

Terminate input or editing of a project line with ENT (see Fig. 5.3).

```

PROJECT DESCR. LINE NO. 1
Project : railway
SELECT: +↑↓→
        ENTER
  
```

Fig. 5.3: Input or editing termination

Repeat steps (3) to (5) for the desired project lines.

(6) Storage

When you exit from the project lines menu with MEN, all information is stored in the internal memory of the Rec. You can then opt to store the information in the MEM E (Fig. 5.4).

```

RECORD PROJECT DATA ?
YES NO
  
```

Fig. 5.4: Recording

- YES: The project data is stored in the MEM E.
 NO: The project data is not stored in the MEM E.

The logo for "Geodesical" features the word in a bold, blue, sans-serif font. A light blue, three-dimensional ring or sphere is positioned behind the letter "G", partially overlapping it and extending to the left.

 **Geodesical**

6. Input

(1) Purpose

Display and editing of parameters required for the correction and reduction of measurements.

- Entry of the instrument and reflector heights or of the station and target heights for computing elevations or level differences.
- Entry of the temperature and the atmospheric pressure or automatic sensing for correcting distance measurements based on the current atmospheric conditions.
- Entry of the scale and the addition constant for the correction of distance measurements.

These parameters are stored permanently in the internal memory, i.e. they are not lost when you turn off the Rec Elta.

(2) Program selection

- Call from the main menu (page 1) with numeric key 2
- Direct call with the INP key from any program part; display of the selection menu (Fig. 6.3.1) with the values currently stored.

REFL:	1.500m	TEMP.:	23°C	INPUT MENU
INST:	1.650m	PRESS:	942hPa	SELECT: ↑↑↓↓
ADCO:	0.000m	BAR. H:	615m	ENTER
SCLE:	1.000000	PPM :	0	

Fig. 6.3.1: Selection menu of the INPUT program

(3) Selection of the parameters to be edited

Go to the input field with the cursor keys:

- horizontally: ◀ (left), ▶ (right)
- vertically: ▲ (up) and ▼ (down)

Note:

Automatic acquisition on (SWITCHES program: AUTO (T/P) A):

The input fields show the current values for the temperature and the atmospheric pressure and the barometric elevation derived from them. They cannot be selected (for editing refer to 14., SWITCHES).

(4) Input activation

Confirm correct selection with ENT; simultaneous change to the editing menu (Fig. 6.3.2).

REFL:	1.500m	TEMP.:	23°C	INPUT MENU
INST:	1.650m	PRESS:	959hF	INPUT <input type="checkbox"/>
ADCO:	0.000m	ERR.H:	485m	ENTER
SCLE:	1.000000	PPM :	0	

Fig. 6.3.2: Input/editing menu

(5) Entry editing

The editing position is indicated by the cursor. The cursor is at the first significant position.

The decimal point is fixed and cannot be changed.

The number of decimals for the heights and the addition constant can be selected in the SET program (see 13.3, Decimal Digits).

Key	Function
▶	Cursor moves right one place, digits are not modified.
◀	Cursor moves left one place, digits are not modified. If there is no digit, a zero is set.
0,1,...,9	Input of the digits 0,1,...,9 in the corresponding places, existing digits are overwritten. Deletion of the digits preceding the decimal point by 0.
-	Effective for heights, addition constant, temperature, ppm and barometric height. Can be pressed anywhere in the input field and causes the current sign to be changed.

(6) Editing termination

Terminate input with ENT. The input bounds are checked (see (8) below).

- Result positive:

Return to the selection menu (Fig. 6.3.1); the current value is overwritten in the internal memory.

- Result negative:

The input value is not accepted. When leaving the input menu with MEN the current value is stored again in the internal memory.

(7) Storage in the Mem and exit from the INPUT program

Return to the main menu or to the calling program part with the MEN key (INP key for returning to the INPUT program).

The edited values are stored forcibly in the Mem. This ensures unambiguous assignment to the following measurements.

Remark in the Mem in the point identification area on automatic sensing or manual entry of the atmospheric conditions - ("INPUT VALUES" LT/P AUTOM.) or ("INPUT VALUES" T/P MANUAL).

(8) Input bounds

Temperature	Celsius	:	from	-30° C	to	+70° C
	Fahrenheit	:	from	-22° F	to	+158° F
Pressure	Pascal	:	from	440 hPa	to	1460 hPa
	Torr	:	from	331 Torr	to	1095 Torr
	InchMercury	:	from	13.0 InMerc	to	43.1 InMerc
	Elevation	:	from	≈6400 m	to	≈-3200 m
Scale			from	0.998 500	to	1.001 500
ppm			from	-1 500	to	1 500
Addition constant			from	-0.127 m	to	+0.127 m
			from	-0.416 ft	to	+0.417 ft
Instrument/reflector height						
Heights and level differences			from	-8388.607m	to	+8388.607m

(9) Additional active keys

Key	Function
MEM	Displays the current Mem load Return to calling point with MEN
LEV	Displays the current vertical axis tilt in the sighting (NZ) and tilting axis (NK) directions Return to the calling point with MEN

 **Geodesical**

7. Adjustment

7.1 Survey

(1) Purpose

Extended instrument usage under extreme measurement conditions, transportation, prolonged storage and large temperature variations can cause the instrument to become misaligned. This can cause errored results. Such errors can be eliminated by adjustment and by specific measurement methods.

Manual adjustment is described in the Appendix.

(2) Adjustment mode selection

Call the ADJUST program in the main menu - page 1 - with key 3; the menu and its modes are displayed (see Fig. 7.1.1).

The measurement arrangements given in the modes allow determining and storing correction values for the instrument errors (e.g. in the V INDEX, HZ COLLIMATION, COMPENSATOR modes).



Fig. 7.1.1: Menu of the ADJUST program

(3) Explanation of the modes

V INDEX and HZ COLLIMATION:

Correction values for index and collimation errors are determined in our works before delivery and stored in the Rec Elta. They are applied to all measurements so that measurement is required only in one telescope position.

However, these correction values can be determined again and stored any time in this adjustment menu with the V INDEX and HZ COLLIMATION modes. These errors should be determined again or checked in particular before precise elevation measurements or before precise measurements to targets with large level differences.

The tilting axis error is determined in our works and the correction is stored in the instrument.

EDM SIGNAL:

The optical axis of the rangefinder and the line of sight of the theodolite telescope must coincide to ensure the maximum energy is reflected when you sight the reflector with the telescope. The EDM-SIGNAL mode allows checking the parallelity and adjusting it, if required.

CLOCK:

In the CLOCK mode the date and the time can be set.

COMPENSATOR:

Just as center-point determination is recommended for the alidade level, the center point of the liquid compensator in the Rec Elta 2 and 3 should be checked periodically. **This is required in particular before precise elevation measurement in the COMPENSATOR mode.**

More precise levelling than with the alidade level of the instrument is possible with the digital display of the inclination of vertical axis.

The logo for Geodesical, featuring the word "Geodesical" in a light blue, sans-serif font. A stylized blue ring or orbit surrounds the letter "G".

7.2 V Index

(1) Purpose

Determination of the index correction; should be performed after long storage periods or after instrument transportation, after large temperature variations and before precise elevation measurements.

(2) Initial menu selection

The index correction of the vertical circle can be checked with the V INDEX mode. Press key 1 (Fig. 7.1.1) to call the initial menu (see Fig. 7.2.1) that shows the index correction value and the time it was determined last.

```

Adjust: U-Index          START:ENTER
i -0.0060
                                06.05.1992  11:40
D/T Sta Bat [ ] [ ] [ ] [ ] [ ] [ ] [ ] [ ]
  
```

Fig. 7.2.1: Initial menu of index determination

(3) Input and measurement menu

Press ENT to change from the initial menu to the P.I. input and measurement menu. A point identification can be entered before measurement in the first telescope position for later identification of the index determination (see Fig. 7.2.2).

```

U-Index          Measure Pos. 1: ENTER
[ ] [ ] [ ] [ ] [ ] [ ] [ ] [ ] [ ] [ ]
<-----C-----> <-----I----->
CIC CI I [ ] R-C [ ] [ ] [ ] [ ] Mrk Con [ ]
  
```

Fig. 7.2.2: Input and measurement menu of V Index, position 1

(4) Measurement

After measuring a zenith angle in both telescope positions, the index correction is computed in the Rec Elta and stored together with the two zenith angles.

The measure menu (Fig. 7.2.2) requests you to sight a target in position 1. To increase the precision, set the target only with the horizontal hair. Initiate measurement with the ENT or ENTER key.

After measurement in the first telescope position, the measure menu requests measurement in the second position (Fig. 7.2.3).

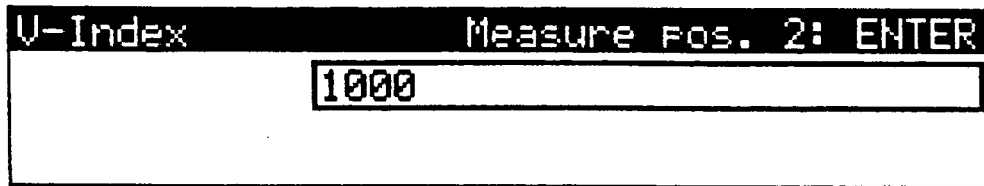

Fig. 7.2.3: Measure menu of V Index, position 2

(5) Index determination result

The old and the new index corrections are displayed in the result menu (Fig. 7.2.4) for comparison. You have to decide which one to use for further measurement.



Fig. 7.2.4: Result of index determination

Key	Function
1	- Old index correction is retained (e.g. determination error) → no storage
2	- New index correction is used for further measurements → storage with zenith angles in two positions
3	- Index correction is set to zero → storage without zenith angles
MEN	- Exit from the menu, → old index value is retained; return to calling program part.

(6) Error condition

If the correction exceeds 2'40" or 49.5 mgrads, no new index correction is computed and an audible signal sounds as a warning.

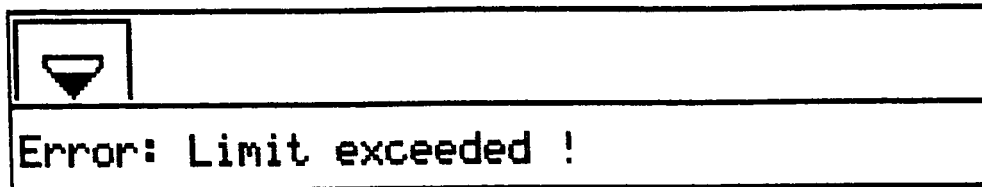

Fig. 7.2.5: Error message

MEN: Exit from the error display. Continue with (3) (Fig. 7.2.2).

The logo for "Geodesical" features the word in a light blue, sans-serif font. A stylized, light blue orbital ring or path curves around the letter "G" and extends slightly to the left of the word.

7.3 EDM Signal

(1) Purpose

The optical axis of the rangefinder and the line of sight of the telescope must coincide to ensure the maximum energy is reflected when you sight the reflector.

(2) Mode selection

The mode appears when you press numeric key 2 in the main menu.

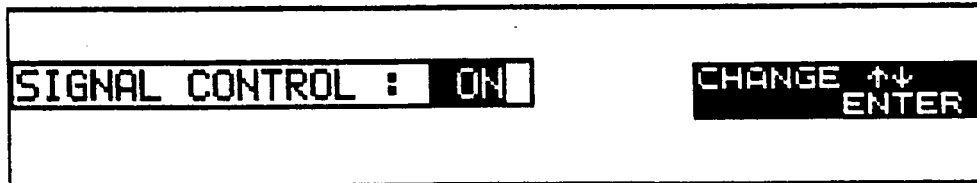

Fig. 7.3.1: Automatic signal control On

(3) Check

Sight a reflector at a distance of at least 200 m - signal control on (Fig. 7.3.1).

To check the adjustment, set a fixed signal amplitude with the cursor keys ▲ (up) and ▼ (down) (Fig. 7.3.2) and confirm with ENT.

Move the reticle away from the center of the reflector with the horizontal and vertical fine motions (24 and 25). If well-adjusted, the signal must decrease.

If no signal is displayed or the signal becomes stronger, the rangefinder is misaligned.

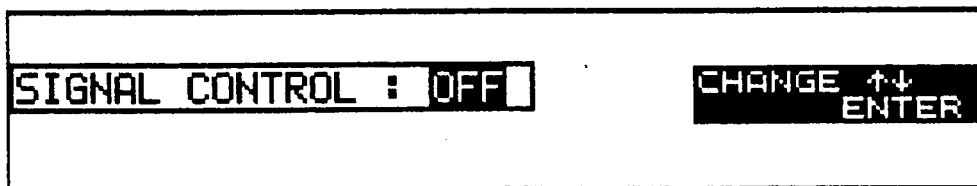

Fig. 7.3.2: Automatic signal control - off

(4) Adjustment

Move the telescope with the fine motions until a signal is displayed.

Loosen both outer lock-screws (internal thread rings) of the rangefinder (4) with a hex adjustment pin and turn the inner screws until the maximum signal amplitude is achieved (do not loosen the adjacent slotted screws).

Shift the distance measuring beam vertically with the lower and horizontally with the upper adjustment screw (4).

Move the reticle closer to the reflector center until just a minimum signal is displayed and repeat the adjustment.

If, for this adjustment, the signal display (bar graph) is at the right outside the range, use the cursor keys \uparrow (up) and \downarrow (down) to turn signal control on (Fig. 7.3.1) until the signal display is in the center. Then turn off automatic control and continue the adjustment work.

Repeat this procedure until the signal display is maximum for central sighting.

Tighten the lock-screws (4).

MEN: Return to the adjustment programs menu (Fig. 7.1.1).

The logo for Geodesical, featuring the word "Geodesical" in a light blue, sans-serif font. A stylized blue arc or swoosh is positioned above the letters "e" and "o", extending from the left side of the "e" towards the right side of the "o".

7.4 Clock

(1) Purpose

Measurements can be assigned time stamps by storing the date and the time. By comparison with a precise watch, the exact time can be set in the Rec Elta or a time zone change compensated.

(2) Mode selection

Call the date and time mode with numeric key 3 in the ADJUST program (Fig. 7.1.1); automatic change to the selection menu of this mode (Fig. 7.4.1).

TIME : 08:57:53	SET CLOCK SELECT: + + + + ENTER
DATE : 12.11.1991	
MODE : DD.MM.YYYY	

Fig. 7.4.1: Selection menu of the date and time mode

(3) Selection of the value to be changed

The selection menu (Fig. 7.4.1) shows the currently stored values. The input field frame is on the first value. Other input fields can be selected with the horizontal and vertical cursor keys.

(4) Input activation

Confirm correct selection with ENT; simultaneous change to the editing menu (Fig. 7.4.2).

TIME : 15:07:25	SET CLOCK CHANGE ↑↓ ENTER
DATE : 13.10.1992	
MODE : DD.MM.YYYY	

Fig. 7.4.2: Editing menu

(5) Setting the time

Select the hours, minutes and seconds with the horizontal cursor keys. Use the numeric keys for editing. Confirm the changes with ENT. The clock then uses the set time.

If you exit with MEN, the time is not changed (the clock continues running internally and displays the unchanged time).

(6) Setting the date

The values can be accessed with the horizontal cursor keys (the sequence depends on the selected mode (see (7))).

Use the numeric keys for editing. Confirm with ENT.

The time display is static during modification, but the clock continues running in the background. When you press the ENT key, the current time is displayed.

If you exit with MEN, no change is made.

(7) Setting the date mode

Use the vertical cursor keys to select one of three different date modes:

TT.MM.JJJJ

TT = Day

MM.TT.JJJJ

MM = Month

JJJJ.MM.TT

JJJJ = Year

When you change the date mode, the date display in the "Set Date" line changes accordingly.

The logo for Geodesical, featuring the word "Geodesical" in a light blue, sans-serif font. A stylized blue orbital ring or path curves around the letter "G" and extends slightly to the right.

7.5 HZ Collimation

(1) Purpose

Checking the collimation correction after long storage periods or after instrument transportation, after large temperature variations and before measurement with steep lines of sight.

(2) Initial menu selection

The collimation correction can be determined with the HZ COLLIMATION mode. Press key 6 (Fig. 7.1.1) to access the initial menu (see Fig. 7.5.1) that displays the value and the time the collimation correction was determined last.

```

Adjust: Hz-Collimation          START:ENTER
c  0.0008
                                06.05.1992 12:40
D/T Sta Bat [ ] [ ] [ ] [ ] [ ] [ ] [ ]
  
```

Fig. 7.5.1: Initial menu of collimation correction

(3) Input and measurement menu

Press ENT to change from the initial menu to the P.I. input and measurement menu. A point identification can be entered for later identification of the collimation correction before you measure in the first telescope position (see Fig. 7.5.2).

(4) Measurement

The measurement menu (Fig. 7.5.2) requests you to sight a target in position 1. To increase the precision, set the target only with the vertical hair. Initiate measurement with the ENT or ENTER key.

```

Hz-Coll.          Measure Pos. 1: ENTER
[ ] [ ] [ ] [ ] [ ] [ ] [ ] [ ] [ ] [ ]
<-----C-----> <-----I----->
ClC ClI [ ] R-C [ ] [ ] [ ] Mrk Con [ ]
  
```

Fig. 7.5.2: Input and measurement menu of HZ Coll-position 1

After measurement in the first telescope position, the measurement menu requests measurement in the second position (Fig. 7.5.3); initiate measurement with the ENT key.

After measurement of a horizontal direction in both telescope positions, the collimation correction is computed in the Rec Elta and stored together with the two directions.

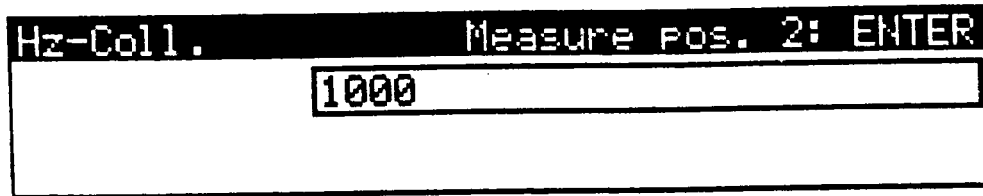

Fig. 7.5.3: Measurement menu of Hz Coll - position 2

(5) Result of collimation correction determination

The old and the new collimation correction is displayed in the result menu (Fig. 7.5.4) for the decision which of the two is to be used for further measurements.

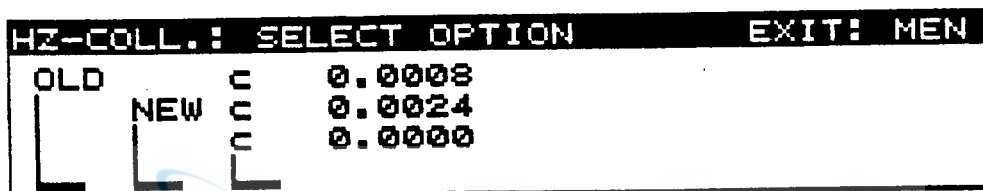

Fig. 7.5.4: Result of collimation correction determination

Key	Function
1	Old collimation correction is retained (e.g. determination error) → no storage
2	New collimation correction is used for further measurements → storage with directions in two positions
3	Collimation correction is set to zero → storage without directions
MEN	Exit from the menu, → old value is retained; return to calling program part.

(6) Error condition

If the correction exceeds 2'40" or 49.5 mgrads, no new collimation correction is computed and an audible signal sounds as a warning.

If this error condition doesn't refer to an aiming error the reticle should be adjusted manually (see Appendix A 7.1).

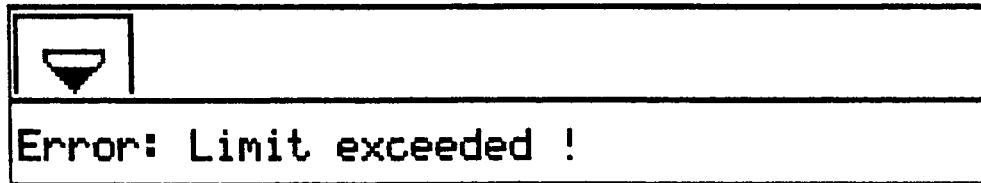

Fig. 7.5.5: Error message

MEN: Exit from error display. Continue with (3) (see Fig. 7.5.2).

The logo for Geodesical, featuring the word "Geodesical" in a blue, sans-serif font. A blue, stylized orbital ring or path surrounds the letter "G".

7.6 Compensator

(1) Purpose

Just as center-point determination makes sense for the alidade level, the liquid compensator in the Rec Elta 2 and 3 requires periodic checking by center-point determination with the COMPENSATOR mode especially before precise elevation measurements.

(2) Initial menu selection

Press key 7 (Fig. 7.1.1) to access the initial menu (Fig. 7.6.1) which displays the center-point components in the tilting (SK) and the sighting axis (SZ) directions and the time these values were determined last.

```
Adjust: Compensator          START:ENTER
SK   0.0046
SZ  -0.0030                06.05.1992  11:49
D/T Sta Bat [ ] [ ] [ ] [ ] [ ] [ ] [ ] [ ]
```

Fig. 7.6.1: Initial menu - compensator adjustment

(3) Center-point determination

The compensator enters its operating range when you level the Rec Elta with the level, and then automatically compensates any residual vertical axis tilts.

To determine the center point precisely, it is important to allow time for the liquid in the compensator to settle. This is why the Rec Elta should be stabilized with the horizontal clamp (26) before measurement.

Press the ENT key to initiate compensator measurement in position 1 (Fig. 7.6.2).

```
Adjust: Compensator          START:ENTER
      1. Levelling
      2. Clamp Hz
      3. ENTER
```

Fig. 7.6.2: Compensator measurement in position 1

As for center-point determination with the alidade level, turn the Rec Elta through 200 grads (180°) to ± 5 grads (5°). Again stabilize the instrument with the Hz clamp and initiate the compensator measurement in position 2 with the ENT key.

Adjust: Compensator	START: ENTER
1. Turn Hz $\rightarrow 0$ (+5/-5) 2. Clamp Hz 3. ENTER	

Fig. 7.6.3: Compensator measurement in position 2

(4) Result

After computation, the center-point components and the residual axis tilts are displayed (see Fig. 7.6.4)

LEVELLING		Exit: MEN	
SK	0.0054	- NK	0.0084
SZ	-0.0055	NZ	0.0064

Fig. 7.6.4: Center-point components

where:

SK	0.0038	Center-point component in tilting axis direction
SZ	-0.0004	Center-point components in sighting axis direction
-NK	-0.0012	Tilt in tilting axis direction
NZ	0.0014	Tilt in sighting axis direction
positive value		Tilt to the right or front
negative value		Tilt to the left or rear

If no error occurred, the SK and SZ values and the date and time are recorded automatically.

Levelling is then possible with the digital display (see (7), Levelling with the compensator).

(6) Error condition

If the center-point values exceed

$$SK = \pm 51.5 \text{ mgrads} = \approx \pm 2'47''$$

$$SZ = \pm 25.5 \text{ mgrads} = \approx \pm 83''$$

then Fig. 7.6.5 indicates the determination error.

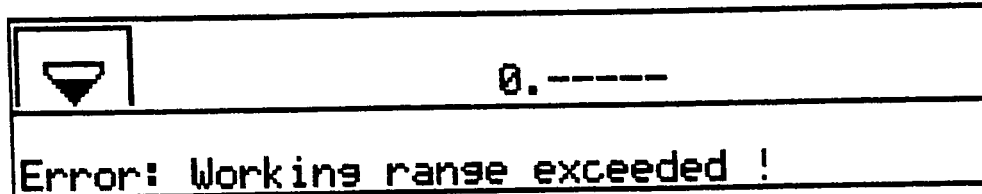

Fig. 7.6.5: Error message

MEN: - Prior center-point values are retained.
- Then branch to the ADJUST program menu.

(7) Levelling with the compensator

More precise levelling than with the alidade level of the instrument is possible with the digital display of the inclination of vertical axis also in this program. Because of the one-axis compensator only the inclination of vertical axis in the direction of the collimation axis is displayed with the Elta 4 and 5.

Precise levelling with the tribrach screws (19) is obtained when about zero is displayed for both tilts. However, more precise levelling is not absolutely required if compensation is on because the applicable correction values for the vertical axis tilts are applied automatically to the horizontal and vertical circle readings.

Precise levelling can make sense if the compensator has to be turned off for any following measurements because of vibrations.

LEVELLING		Exit: MEN	
SK	0.0054	- NK	0.0084
SZ	-0.0055	NZ	0.0064

Fig. 7.6.6: Levelling with the digital display

If the compensator operating range of $\pm 2'40''$ is exceeded for levelling, an appropriate message appears in the display (see Fig. 7.6.7).

```

LEVELLING                               Exit: MEN
SK   0.0048      -   right
SZ  -0.0051      |   behind
  
```

Fig. 7.6.7: Tilt direction

Explanations to Fig. 7.6.7:

Tilt to the left	-	Display "left"
Tilt to the right	-	Display "right"
Tilt to the rear	-	Display "rear"
Tilt to the front	-	Display "front"

If the range of $\pm 5'$ is exceeded, an audible warning signal sounds and an information appears (Fig. 7.6.8)

```

LEVELLING                               Exit: MEN
SK   0.0048      0.-----
SZ  -0.0051      0.-----
Error: Working range exceeded !
  
```

Fig. 7.6.8: Out of range

Return with ENT or MEN to the calling program part or to the ADJUST menu.

Important:

The digital display of the inclination of vertical axis can be called in the whole program with key LEV.

7.7 Display

(1) Purpose

By adjusting the contrast of display it can be accorded to the environmental conditions.

(2) Mode selection

Press numeric key 8 to access the editing menu. The option set last is displayed (see Fig. 7.7.1).



Fig. 7.7.1: Editing menu

(3) Mode change

You can select NORMAL, DARK or BRIGHT with the cursor keys ↑ (up) and ↓ (down) (see Fig.7.7.2).



Fig. 7.7.2: Option selection

(4) Modification storage

- ENT: -The desired setting is stored.
-Return to the ADJUST program.
- MEN: -The setting selected last is retained.
-Branch to the ADJUST program.

 **Geodesical**

8. Common Features of the MEASURE, SPECIAL and COORDINATES Programs

This chapter describes the major common features of the MEASURE, SPECIAL and COORDINATES programs. After the completion of the turn-on routine (see 3., Measurement Procedure), page 1 of the main menu appears automatically. Here one of the 3 programs can be selected (see Fig. 8.1).



Fig. 8.1: Main menu - page 1

The appropriate program can be selected with the associated numeric key.

8.1 Program Call

Example: MEASURE program

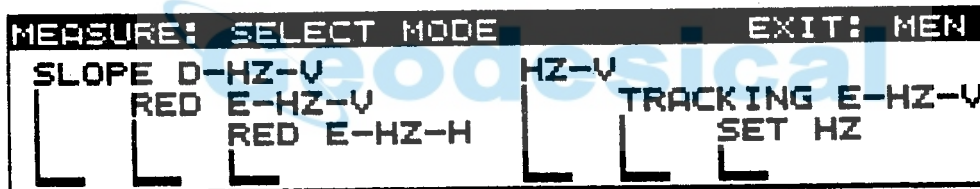

Fig. 8.1.1: Measurement program with modes

Line 1: Inverted representation of the dialog line
 - Measurement: program display with the request to select the mode
 - MEN: Exit (return to the main menu)

Lines 2 to 4: Display of the modes; the "L" symbol refers to the individual numeric keys

8.2 Mode activation

The desired mode can be selected with the associated numeric key, e. g.:
Key 3: E - HZ - H



Fig. 8.2.1: Mode display

- Line 1: Inverted display of the dialog line
 - MEASURE: E - HZ - H = Program with mode
 - ENTER: Start of the mode
- Line 2: Display of the scale for the following distance measurements. In some modes, M is always 1.000000!
 For pure angle measurement modes, no scale is displayed.
- Line 3: Soft keys

Key	Function
D/T (FCT + 1)	Date and time
Sta (FCT + 2)	Initial condition of major instrument parameters
Bat (FCT + 3)	Battery capacity
Com (FCT + 4)	Compensator center-point determination
Ind (FCT + 5)	Index correction determination
Col (FCT + 6)	Collimation correction determination

The soft keys can be activated with the FCT key and numeric keys 1 to 6.

8.2.1 Soft key description

(1) Date and time display (D/T)

The date and the time are displayed for approx. 2 seconds.

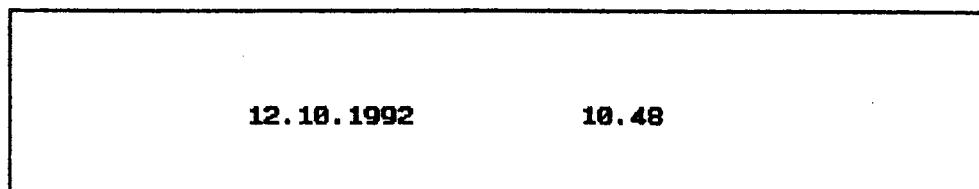

Fig. 8.2.1.1: Date and time

(2) Display and storage of the initial condition (Sta)

Documentation of the instrument status at measurement time for later measurement assessment.

This soft key groups parameters in a single list that were determined or entered in several menus (see Fig. 8.2.1.2).

ih	1.500m	i	-0.0037	13.10.1992	1111	04
th	1.650m	c	0.0024	13.10.1992	1111	11
T_	0.000m	SK	0.0048	13.10.1992	1111	20
P_	1.000000	SZ	-0.0051	13.10.1992	1111	20
m	959hP	METER/GRD/ZENITH/XYZ/				
A	23°C	HPA/MB/C/				

Fig. 8.2.1.2: Initial condition

List of the displayed parameters:

Input parameters (see also 6., Input) and abbreviations

- Instrument height ih
- Reflector height (target height) th
- Temperature T_
- Atmospheric pressure P_
- Scale m
- Addition constant A

Instrument errors (see also 7., Adjustment):

Date and time of determination and value of

- Index error i
- Collimation error c
- Position of the compensator center-point
in the direction of the
- tilting axis SK
- line of sight SZ

Units (see also 12., Units):

- Distance measurement
- Angle measurement
- Vertical reference system
- Coordinate system
- Atmospheric pressure
- Temperature

The Sta function can be left with any key. The request appears automatically if the current condition is to be added to the documentation in the Mem (see Fig. 8.2.1.3).

<p>RECORD INSTRUMENT STATUS ?</p> <p>YES NO</p>

Fig. 8.2.1.3: Recording

YES: Recording of the values, branch to the initial menu

NO: No recording of the values, branch to the initial menu

(3) Battery condition (Bat)

When you press the soft key Bat, the battery condition is displayed by a bar graph in the Elta display (see Fig. 8.2.1.4).

<p>BATTERY CONTROL: SEE ELTA DISPLAY !</p>
--

Fig. 8.2.1.4: Battery display

MEN: Change to the initial menu of the measurement program (Fig. 8.1.2).

(4) Compensator center-point determination (Com)

Direct branch to the initial menu of the COMPENSATOR mode. After center-point determination or after abnormal termination, MEN returns you to the initial menu of the measurement mode.

(5) Index correction determination (Ind)

Direct branch to the initial menu of the V-INDEX mode. After determination of the index correction or after abnormal termination, MEN returns you to the initial menu of the associated measurement mode.

(6) Collimation correction determination (Col)

Direct branch to the initial menu of the HZ COLLIMATION mode. After determination of the collimation correction or after abnormal termination, MEN returns you to the initial menu of the associated measurement mode.

8.3 Input and Measurement Menu

In the MEASURE program, ENT takes you directly from the initial menu to this menu. In the SPECIAL and COORDINATES programs, other definitions (e. g. station) have to be made beforehand.

Input P.I.		Measure point: ENTER	
ih	1.650m	[]	
th	1.500m	<-----C-----><-----I----->	
[C]	[I]	[Ino]	[R-C] [Ecc] [Inf] [D:R] [Mk] [Con] ->2

Fig. 8.3.1: Input and measurement menu

8.3.1 Display description

- Line 1: Dialog line
 - Request to enter the P.I.
 - Start with ENT or ENTER
- Line 2: 27-character display for P.I. input
- Line 3: Format of the mark selected last
- Line 4: Soft keys

8.3.2 P.I. input

Input P.I.		Measure point: ENTER	
ih	1.650m	AR 1502	corner
th	1.500m	<-----C-----><-----I----->	
K	L	M	N O P Q R S T

Fig. 8.3.2.1: P.I. input

(1) Purpose

Identification and description of a point before a measurement to obtain a unique correlation between the point and the measurement.

(2) Format of the P.I. (see Fig. 8.3.2.1, line 2):

- Point identification (P.I.) = point code (C) + additional information (I).
Up to 27 characters (letters, digits, special characters and spaces).

- Point code = point number in numeric and/or alphanumeric form.

The number of characters may range from at least 3 to a maximum of 14. Incrementing is possible in this range (see 8.3.4 (3)).

Unused character positions may be used for additional information or may contain spaces.

- Additional information = point description in alphanumeric form.

For alphanumeric entries, the first 9 letters of the alphabet appear instead of the soft keys after pressing of the ABC key

A B C D E F G H I J

All other letters and special characters can be selected with the vertical cursor keys \uparrow , \downarrow .

(3) Input

To facilitate input,

1. the input field has a frame (input window) and
2. the point identification is provided with a mark (see 8.3.3 below and 13.2, SET).

8.3.3 Result

Line 1 : Result display (when measurements have already been made)
- Display of the results in the selected unit

Line 2 : Display of the address of the last record

8.3.4. Marks**(1) Purpose:**

Input support by graphical subdivision of the P.I. into fields.
This improves the readability of the P.I.

(2) Format:

The format depends on the number of characters for the point code and the additional information.

Default mark: <-----C-----><-----I----->

(3) Set:

In the SET menu (see 13.2), the mark format can be selected. The following parameters can be set there individually:

- Tab function (facilitates input)
- Beginning and end of the point number field
- Spaces that are skipped during P.I. input
- Places for storing the time
- Up to 7 different marks can be defined and called with the soft key Mrk.

(4) Call:

Each time you press the soft key Mrk, a mark appears. The new mark is retained for all measurement programs until you change it again.

8.3.5 Function keys and soft keys**(1) Purpose:**

Flexible measurement and point input support.

(2) Function keys

Functions:

- Geodesical
- | | |
|-----------|--|
| TAB | Tab function according to the parameters set in the SET program. |
| FCT | Function key for selecting the soft keys together with numeric keys 1 to 0. |
| ABC | Function key for activating alpha input (see 8.3.2), i.e. input of capital or lower-case letters and of special characters with soft key line 4. |
| 1, ..., 0 | Keys for entering digits and selecting soft keys. |
| - | Negative entries or special characters for the P.I. |
| . | Special characters for the P.I. |
| Spacebar | Functions as cursor-right and deletes the existing entries. |
| ▶, ◀ | Cursor keys for selecting a position for entry or editing without deleting the cursor position. |

(3) Soft keys

Simultaneously press FCT and the associated numeric key.

Key	Function
CIC (FCT + 1)	Cancels the point code in the point identification P.I.
CII (FCT + 2)	Cancels the additional information in the point identification P.I.
Ino (FCT + 3)	Point number incrementation on or off
R-M (FCT + 4)	Recording mode activation/deactivation (measured and/or computed values or no recording)
Ecc (FCT + 5)	Input of an offset
Inf (FCT + 6)	Input of an information line
D:N (FCT + 7)	Selection of the measurement mode for the rangefinder
Mrk (FCT + 8)	Scrolling in a table of (user-defined) marks to support P.I. input
Con (FCT + 9)	Compensation on or off
→ 2 (FCT + 0)	Selection of line 2
DTh (FCT + 1)	Selection of the measurement mode (distance and angle measurement or angle measurement only)
→ 1 (FCT + 0)	Selection of line 1

Point identification deletion with soft keys CIC and CII

The point code field is deleted completely by soft key CIC and the additional information field by soft key CII. Both fields are then free for new entries. Individual characters can be canceled with the spacebar.

Incrementation activation/deactivation with soft key Ino/Ino

- Purpose

Automatic incrementation or decrementation of the point number by a desired amount.

When you select the measurement mode, incrementation is off (Ino). Turn on incrementation with FCT + 3. Change from the P.I. input menu to Fig. 8.3.4.1: Increment entry.

The default increment is 1.

Confirm with ENT

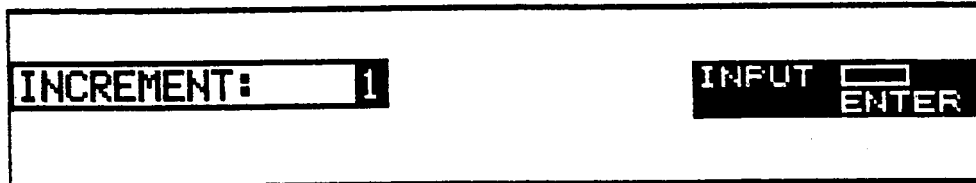

Fig. 8.3.4.1: Increment entry

- Increment entry

Enter the new increment starting at the cursor position ||| . The input bounds ($-9999 \leq \text{incr} \leq 99999$) are checked automatically. A warning sounds for wrong entries.

Key	Function
1, ..., 0	Input of the desired increment with the numeric keys. After each digit, the cursor moves one position to the right.
◀	Entries at the left of the cursor are possible if you move the cursor to the desired field with the ◀ key. Any existing digits are not modified. If there is no digit, zeros are set.
▶	The cursor moves right one position without modifying the digit. Leading zeros are deleted.
-	Input of negative increments
-	Increment entry termination

Terminate entry with the ENT key; return to point identification input in the measurement program that was left earlier.

Change of soft key Ino/Ino: Information on incrementation activation/deactivation.

- Important:

Only the right-most numeric part of the point code is incremented. The point number can only be changed as far as leading spaces exist before the point number. Incrementation up to 9 999 999

Recording activation/deactivation with soft keys R-M/R-C/RMC/Rno**- Purpose**

Individual selection of the recording mode.

Soft key FCT + 4 enables you to select different recording modes.

If a Mem is inserted, the default recording mode is set at the beginning of any measurement mode (R-M, R-C etc.).

If no Mem is inserted, recording is off (Rno) and you cannot change this condition. All measurement functions are retained.

If in the SWITCHES menu the the "Record" switch is set to "OFF", the softkey in a measurement mode is set by default to Rno.

- Possible switch settings

Rno = Measurement is not recorded.

R-M = Original measurement values (D, Hz, V) or (Hz, V) are recorded.

R-C = Data computed from the measured values is recorded, e.g. E, Hz, h - Y, X, Z

RMC = Measured and computed values are stored

1st line: measured values

2nd line: computed values

Important:

- | | |
|-----------------------|---|
| Recording successful: | <ul style="list-style-type: none"> - Display of the record in line 1 - Display of the address in line 2 - audible signal for every recorded line |
| Recording off: | <ul style="list-style-type: none"> - Display of the record in line 1 without address - the address is still missing - no audible signal |

Offset input

- Purpose

Points that are not directly visible from the station can be measured by entering an offset.

REFL. :	IN FRONT	CENTER	ECCENTRIC PT
DIST. :	1.550m		INPUT <input type="checkbox"/>
MODE :	OFF		ENTER
ELEV. :	NO		

Fig. 8.3.4.2: Offset input

- Options:

Refl.: Before center
 Left of center
 Behind center
 Right of center
 Spatial to center (reflector is on the line of sight between the station and the target)

Length: Offset value

Mode: Off
 Continuous
 Once

Height: No
 Yes

- Modification input

Key	Function
-----	----------

▲,↓	Option selection, option scrolling
ENT	Confirmation of selection or modification
MEN	Return to the calling menu

In the MEASURE program, the direction and the horizontal distance to the centre are computed (exception: mode D-Hz-V). In the SPECIAL and COORDINATES programs, the coordinates of the center are computed, or values, referred to the centre, are derived. If you enter YES for the height,, the offset point and the centre must have the same height.

Independent of the offset option by the softkey "Ecc", when having sight

connection to the centre, it is possible to sight the target in the horizontal and vertical angle. to press ENT in order to start the angle measurement and then to sight the offset position of the reflector. Now the distance is measured. The measured offset distance is then handled like a centric distance. The height of the centre as well as of the offset point are supposed to be identical.

Information line input with soft key Inf

- Purpose:

Input of additional information on a measurement.

Can be selected in the measurement menu by pressing the soft key Inf. Change from the input menu of the measurement mode to Fig. 8.3.4.3

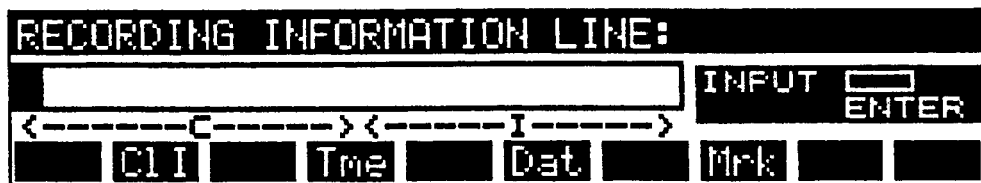

Fig. 8.3.4.3: Information input

- Input

The cursor in the first position of line 2 indicates input readiness. Select the input position with the horizontal cursor keys \blacktriangleright , \blacktriangleleft . Digits can be entered directly, letters and special characters with the ABC key or directly with the vertical cursor keys \uparrow , \downarrow . The soft keys Tim (FCT + 4) and Dat (FCT + 6) afford direct input of the time and the date in the information line.

- Input deletion

Complete deletion with soft key CII (FCT + 2), individual characters with the spacebar.

- Termination:

MEN: Return to the measurement program without storage

ENT: Input termination with storage at an address

Rangefinder measurement mode selection with soft key D:N/D:L/D:R

- Purpose

Matching to different measurement requirements such as rapid measurement or measurement of long distances.

- Selection

In the measurement menu by pressing soft key D:N.

D:N = Normal (default value in the input menu of the measurement mode)

D:L = Long (option for longer distance or worse sight conditions)

D:R = Rapid (rapid-measurement option)

Within a measurement mode, the selected option remains active until you change it again.

Mark selection with soft key Mrk

- Purpose

Tailoring to measurement task by selecting different marks that support point identification P.I. input.

- Selection:

When you call a measurement mode, the mark used last is displayed automatically (line 3 of the input menu of the measurement mode).

Call the marks defined in the SET program (13.2) with soft key Mrk. Step to the desired mark by pressing the soft key repeatedly.

The new mark is used in all measurement programs until you select another one.

Compensation activation/deactivation with soft key Con/Cno

- Purpose:

Compensation can be turned off for reading angles even in the presence of strong vibrations.

- Selection

Soft key Con shows the switch setting selected in program 14., SWITCHES. It can be changed by pressing FCT + 9.

- Function:

Con: Compensation of the vertical axis tilt by computed correction of the read angle values.

Cno: No correction.

Switchover to theodolite measurement with soft key DTh/Th

- Purpose

Measuring angles only in the D-HZ-V, E-HZ-V or stationing modes (e.g. measurement to a church steeple) is possible without mode change with soft key DTh/Th.

- Selection

Soft key 1 in line 2: Line change with FCT + 0.

FCT + 1 to set the Th mode.

The change remains effective until you change back manually.

Measurement duplication with soft key Cpy**- Purpose**

A measurement can be duplicated with soft key Cpy to avoid multiple measurements to a point with differing point identifications.

The point identification must be changed beforehand if necessary.

- Selection

Soft key 5 in line 2: Line change with FCT + 0, then FCT + 5.

The following request appears:

E	5.009 Hz	320.9852 h	0.636
Add.	181	2537	end of line
COPY THIS RECORD ?			YES NO

Fig. 8.3.4.4: Duplication with soft key Cpy

YES: Storage of the record and return to the calling measurement mode

NO: Return to the calling measurement mode

The logo for Geodesical features the word "Geodesical" in a bold, blue, sans-serif font. A light blue, three-dimensional ring or orbit surrounds the letter "G", giving it a technical or scientific appearance.

 **Geodesical**

9. MEASURE Program

9.1 Survey

(1) Purpose

The MEASURE program provides six modes (see Fig. 9.1.1) for determining, displaying and recording the measurement elements that are most common in daily work. Directions, angles, distances and heights or height differences can be selected in different combinations.

(2) Measurement mode selection

Select the MEASURE program with numeric key 6 in the main menu. The menu of the measurement programs appears (see Fig. 9.1.1). The modes can be selected directly with the numeric keys indicative of the (L) symbols.

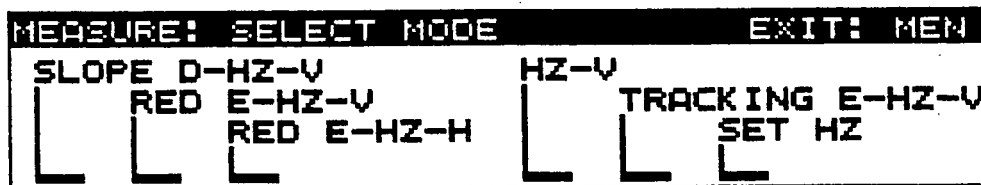

Fig. 9.1.1: Menu of the measurement programs

MEN: Return to the main menu

(3) Explanation of the modes

Mode 1: Determination of the original measurement elements D, HZ, and V

D = Slope distance
 HZ = Horizontal circle reading
 V = Vertical circle reading

Mode 2: Determination of the horizontal distance and angle values

E = Horizontal distance
 HZ = Horizontal circle reading
 V = Vertical circle reading

 **Geodesical**

10. SPECIAL Program

10.1 Survey

(1) Purpose

The SPECIAL program offers four modes (see Fig. 10.1.1) for solving common surveying problems.

From the original measurement elements D, HZ, V or HZ, V, the values required by the application are computed, displayed and stored.

(2) Mode selection

Select the SPECIAL program with numeric key 7 in the main menu. The menu of the special programs (Fig. 10.1.1) appears.

The modes can be selected directly with the numeric keys indicated by the (L) symbols.

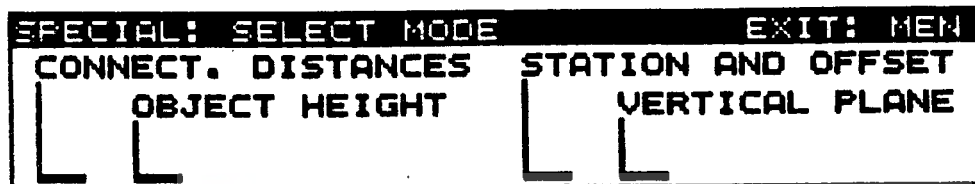

Fig. 10.1.1: Menu of special programs

Geodesical

(3) Modes description**Mode 1: Connecting distances**

Determination of

- D = Slope distance
- E = Horizontal distance
- h = Height difference between
- the first sighted and all further points (function 1►P, soft key 5)
- two consecutively sighted points (function P►P, soft key 5).

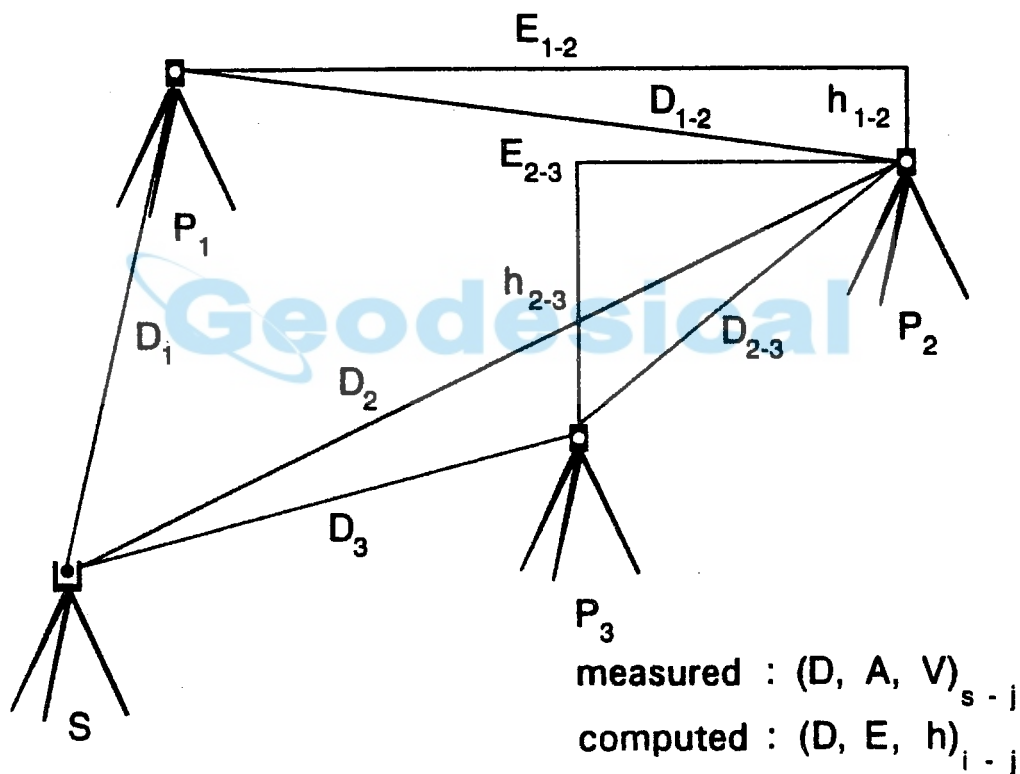

Fig. 10.1.2: Connecting distances

Mode 2: Object height measurement

Determination of:

- E = Horizontal distance between instrument and target
- O = Lateral deviation from the line between the instrument and the target
- Z = Height of the target above
 - the ground surface if you enter the reflector height th
 - MSL if you enter the MSL elevation of the reflector ($H + th$) or after stationing of elevation

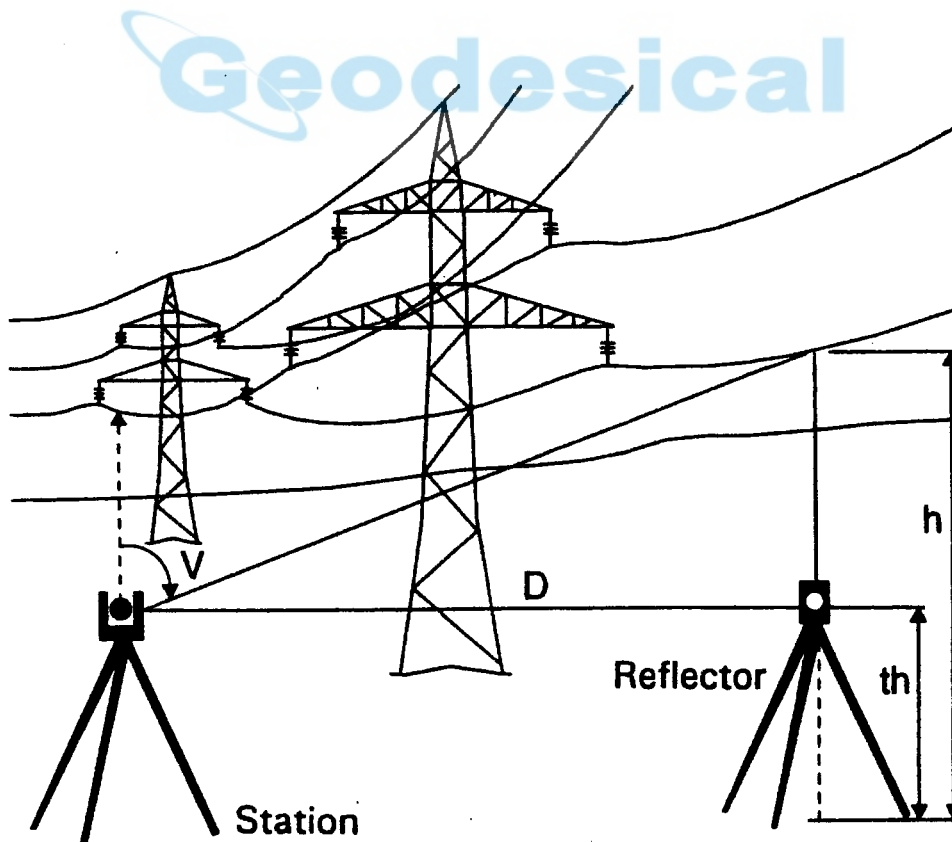

Fig. 10.1.3: Object height

Mode 6: Point-to-line distance

Determination of distances in a local coordinate system with P_1 as origin of the coordinate system and the line $P_1 - P_2$ as the x-axis.

- x = Distance of the plumb line point from the start point P_1
- y = Orthogonal distance of a point from the line P_1-P_2
- h = Height difference between P_1 and P_2
- Z = Height of the target P_i

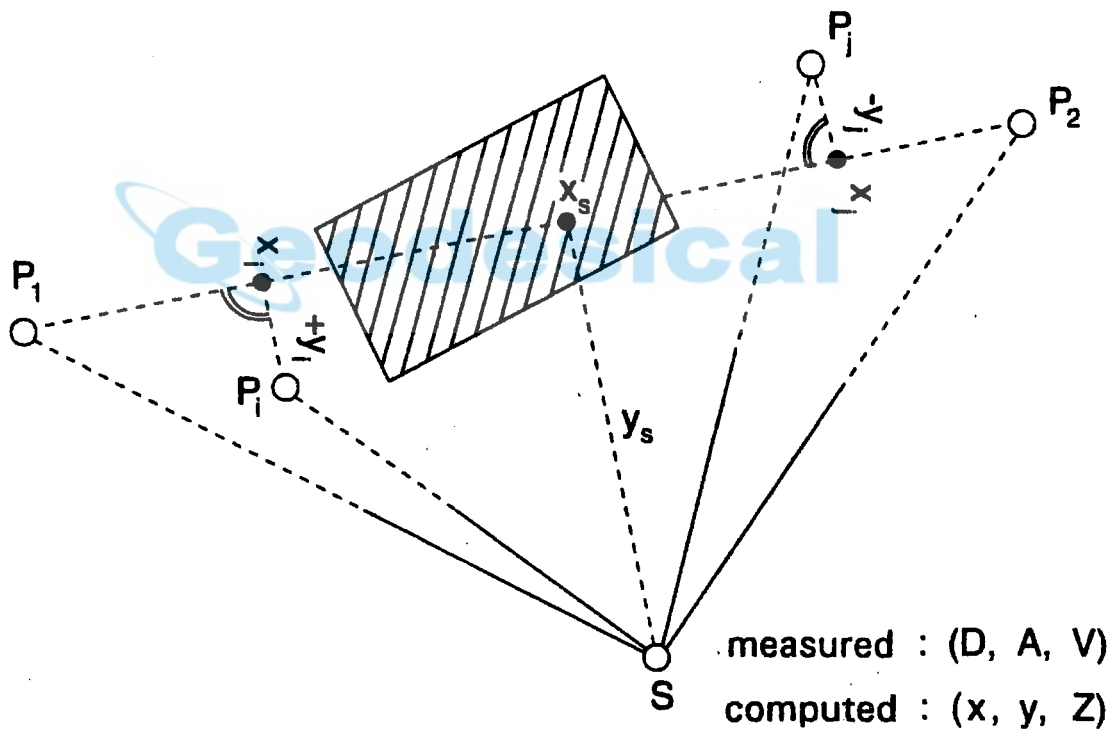

Fig. 10.1.4: Point-to-line distance

Mode 7: Vertical plane

Determination of

- y = y coordinate referred to P1 - P2, always 0 since no offset point is possible in the plane
- x = x coordinate referred to P1 - P2
- h = Height difference between P1 - P2 or P1 - Pi
- Z = Height of the station referred to P1 or MSL
- E = Distance P1 - Pi
- Hz = Angle between the vertical plane and the projection of the line of sight

Display Elta

E =
A =
h =

Display Rec E

y =
x =
z =

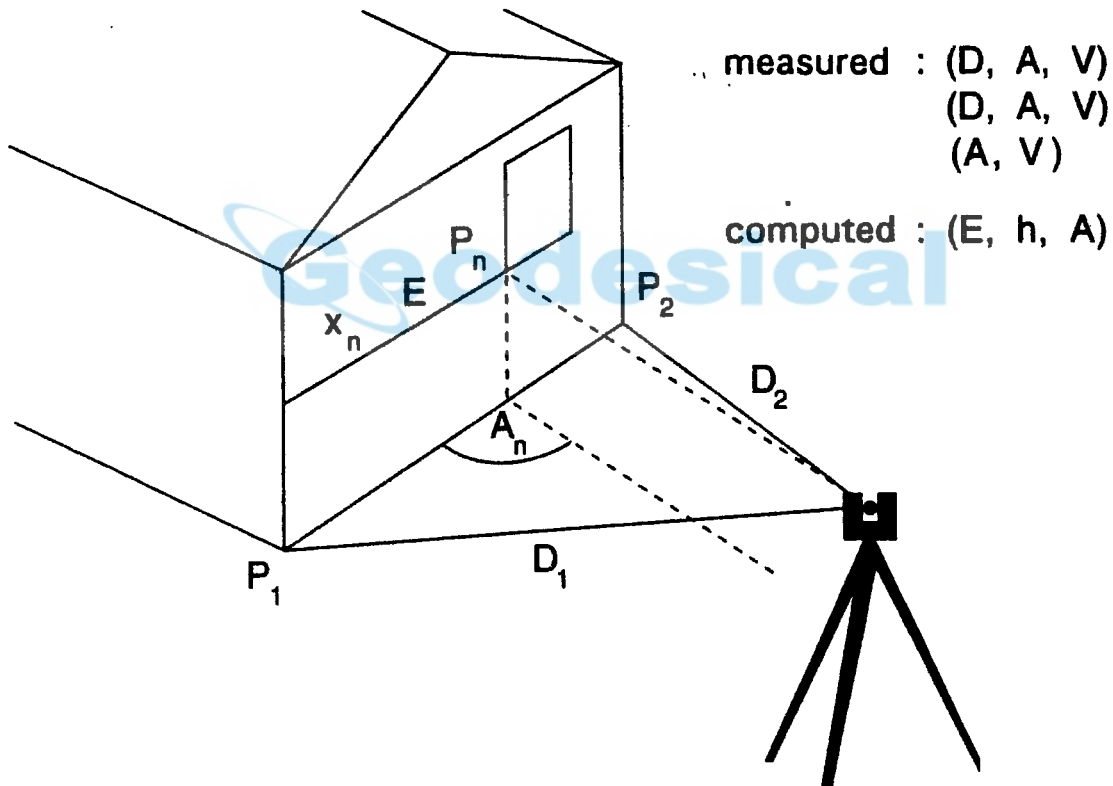

Fig. 10.1.5: Vertical plane

10.2 Connecting Distances Mode

(1) Purpose

Distance and angle measurements from a station to two points supply as connecting distances the slope distance (D), the horizontal distance (E) and the height difference (h) between

- the sighted point and the first point (soft key 1 → P)
- consecutive points (soft key P → P).

(2) Mode selection

Call the connecting distances mode with numeric key 1 in the SPECIAL program (see Fig. 10.1.1); automatic change to the initial menu of this measurement mode (Fig. 10.2.1).

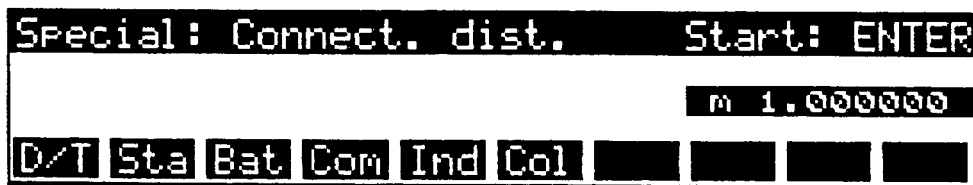

Fig. 10.2.1: Initial menu of connecting distances

(3) Coordinate system selection



Fig. 10.2.2: Coordinate system selection

MEN: Return to SPECIAL menu

1. Local system (key 1)

In addition to the actual connecting distance, the area between the measured points can be calculated in the local coordinate system using the F1 softkey.

(4) P.I. entry

ENT: Starts the mode

Enter the point identification in line 2 of Fig. 10.2.3.

Input P.I.		Measure point 1:ENTER
ih	1.650m	
th	1.500m	<-----C-----><-----I----->
CIC	CI	Ind R-C P→P Inf D=N Mrk Con →2

Fig. 10.2.3: Input menu of connecting distances

(5) Measurement to first point

Sight the reflector of the first point and initiate measurement with ENT or ENTER.

Input P.I.		Measure point 1:ENTER
ih	1.650m	1451
th	1.500m	<-----C-----><-----I----->
CIC	CI	Ind R-C P→P Inf D=N Mrk Con →2

Fig. 10.2.4: Measurement of connecting distances

After the measurement the values are recorded corresponding to the setting of softkey 4 - R-M, R-C or RMC. Continue with (6).

(6) Measurement to the next point

Enter the point identification for the next point in line 2.

Sight the reflector of the second point and initiate measurement with ENT or ENTER.

(7) Result menu

When measurement to the first two points is completed, all three determined elements are displayed in line 1 (Fig. 10.2.5).

The Elta display displays the original measured values D,HZ,V. Angle changes (HZ and V) are displayed continuously.

The cursor in line 2 of the input field requests input of the new P.I.

For further measurements, repeat steps (5) and (6).

D	4.503	E	4.488	h	-0.367
Add.	198	1452			
th	1.500m	<-----C-----> <-----I----->			
CLC CL I Ino R-C P→P Inf D:N Mrk Con →2					

Fig. 10.2.5: Result menu of connecting distances

(8) Recording

The measurements are recorded automatically if soft key 4 is R-M, R-C or RMC.

Recording successful: the address is displayed in line 2 before the P.I. input field.

Important: If soft key 4 is Rno, recording is off. The address is missing in line 2 in this case.

(9) Area calculations

If the measured points are the corners of an area, the enclosed area can be computed after at least 3 points have been measured. The softkey FL is available on the second softkey row for this purpose. The number of corner points is limited to 60.

FL: The following will be displayed (Fig. 10.2.6):

- Connecting distance D, E and h between the last and first points
- Area between the corner points
- Number of corner points, np.

D	1.816	E	1.815	h	0.047
F1	2.99	np	3		
RECORD THIS DATA SET ?					YES <input type="checkbox"/> NO <input type="checkbox"/>

Fig. 10.2.6: Area display

YES: Record the values, and jump from this mode to the SPECIAL program

NO: Further corner points may be measured. In this way it is possible to inspect intermediate results; these results will not be recorded.

N.B.:

If an area is to be recorded, it is recommended that you work only with the P → P option. In this mode, distances, for example boundary lengths, will be displayed and stored as connecting distances.

The logo for 'Geodesical' features the word in a light blue, sans-serif font. A light blue elliptical ring is positioned behind the 'G' and extends slightly to the left and right, partially overlapping the letters.

2. Coordinate system (key 2)

The connecting distance can be determined in a reference coordinate system. It is then possible to recall the first point from memory, or to enter it. It is not necessary in the case to measure the point again.

The last station will be displayed.

Y	6534.750X	7523.842Z	503.458
m	1.000000 Om	182.6502 ih	1.650
1500 PP			
STATIONING CORRECT ?			YES NO

Fig. 10.2.7: Display of the last station

Is this station correct?

YES: Continue with (10) Recall P 1

NO: Jump to the SPECIAL main menu

(10) Recall P.I.

The coordinates of point P1 can be recalled from memory using the softkeys 3 - 8, or they can be entered manually.

Recall point P1	ENTER
Add. 201 HPA/MB/C/	
Add. 1 MESSUNG/HZ-V/	
Inf	LAd ?Ad ?Pt ?PI ?4

Fig. 10.2.8: Recall P1

If the standpoint is identical to P 1, the following message is displayed

Connection point = Stand point !!

If the points are selected correctly, the Rec E will go to (6) Measurement to the next point.

(11) Finishing the measurement and leaving the mode

MEN: Direct return to the SPECIAL program.

10.3 Object Height Mode

(1) Purpose

Indirect height determination of an object by vertical angle measurement. A reference point which is in plumb line under the object is measured with a reflector.

Note:

If you want to determine also the lateral distances to the plumb line point, the line of sight and the vertical plane through the object must be orthogonal.

(2) Mode selection

Call the object height mode with numeric key 2 in the SPECIAL program (see Fig. 10.1.1); automatic change to the initial menu of this measurement mode (Fig. 10.3.1).

```

Special: Object height      Start: ENTER
                               m 1.000000
D/T Sta Bat Com Ind Col
  
```

Fig. 10.3.1: Initial menu of object height

(3) Height Stationing

All object point heights are related to the chosen reference system, normally MSL-heights.

```

ELEVATION BY                EXIT: MEN
PREVIOUS STATIONING (ELEVATION ONLY)
MEASURING REFERENCE POINT
  
```

Fig. 10.3.2: Select Height connection

MEN: Return to SPECIAL menu

Key 1: Height stationing
 Case 1: A station is already available.

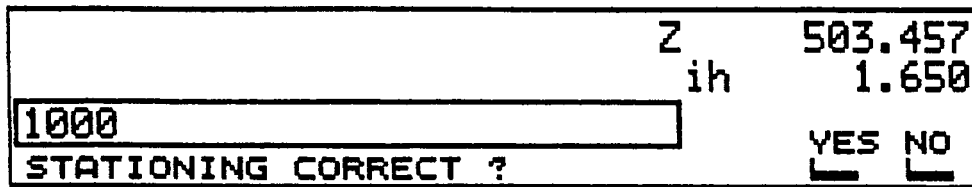

Fig. 10.3.3: Display of Last Station

Is this station correct?

YES: Continue with (4) and enter P.I.

No: Jump to 11.3. Height Stationing

Case 2: No station is available. Go to 11.3 Height Stationing.

(4) P.I. input

ENT: Starts the mode

Enter the point identification in line 2 of Fig. 10.3.4.

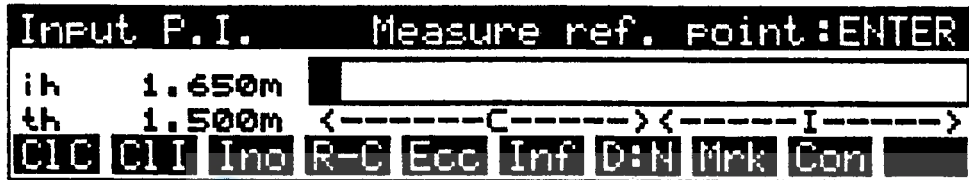

Fig. 10.3.4: Input menu

Important:

The height result depends on the entered reflector height th.

Enter the appropriate height with INP before measurement initiation.

- th = 0 i.e. all heights refer to the reflector as the measurement start point.
- th = Height of the reflector above a reference plane, i.e. all height information refers to this reference plane.
- th = MSL elevation, i.e. all height information is MSL elevation.

(5) Measurement to the reference point

Sight the reflector at the reference point and initiate measurement with ENT or ENTER.

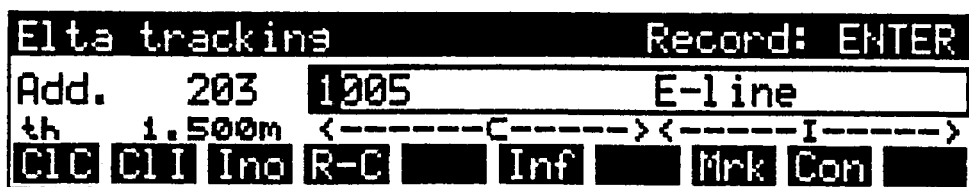

Fig. 10.3.5: Signal display of object height

After the measurement the values are recorded corresponding to the setting of soft key 4 - R-M, R - C or RMC.

The Elta display continuously displays the values E, O and h when you move the telescope.

- E = Horizontal distance between the instrument and the reflector/target
- O = Lateral deviation of the line between the instrument and the reflector
- h = Height of the target.

(6) Measurement to further points

Enter the point identification for the next point in line 2.

Sight the next point (reflector is not required for measurement), ENT or ENTER.

(7) Result menu

The cursor in line 2 in the input field requests input of the new P.I.

E	5.007 0	0.001 Z	10.782
Add.	205	1006	E-line
th	1.500m	<-----C----->	<-----I----->
CIC	CI	Inc	R-C
		Inf	Mrk
			Con

Fig. 10.3.6: Result menu of object height

(8) Recording

ENT: Records the values of the target,
no automatic recording in the tracking mode.

Recording successful: The address is displayed in line 2 in front of the P.I. input field.

Important: If soft key 4 is Rno, recording is off. The address in line 2 is missing in this case.

(9) Measurement termination

MEN: Direct return to the SPECIAL program.

10.4 Point-to-Line Distance Mode

(1) Purpose

Determination of point distances from a reference line specified by two points P1 and P2.

Orthogonal surveys along measurement lines, utility lines, road axes and profile surveys are easy with this mode. Is the instrument station chosen freely the points P₁ and P₂ must be measured. Is the instrument station in a coordinate system the points can be called from the internal memory.

(2) Mode selection

Call the point-to-line distance mode with numeric key 6 in the SPECIAL program (see Fig. 10.1.1); automatic change to the initial menu of this measurement mode (Fig. 10.4.1).

```

Special: Stat. + offset      Start: ENTER
                               m 1.000000
D/T Sta Bat Com Ind Col
  
```

Fig. 10.4.1: Initial menu of point-to-line distance

(3) Coordinate system selection

```

SELECT: SYSTEM              EXIT: MEN
LOCAL SYSTEM
┌   GRID SYSTEM (STATIONING)
└
  
```

Fig. 10.4.2: Coordinate system selection

1. Local system

In the local coordinate system, it is possible to determine the height either by a Height Stationing or by measuring to the first line point.

(4) Height stationing

All point heights are related to the chosen reference system, normally MSL-heights.

```

ELEVATION BY                               EXIT: MEN
PREVIOUS STATIONING (ELEVATION ONLY)
MEASURING FIRST POINT
  
```

Fig. 10.4.3: Select Height Determination

MEN: Return to SPECIAL menu
 Key 1: Height stationing

Case 1: A station is already available.

```

                                Z      503.457
                                ih      1.650
1000
STATIONING CORRECT ?           YES NO
  
```

Fig. 10.4.4: Display of Last Station

Is this station correct?

YES: Continue with (3.1.2) P.I. input
 NO: Jump to 11.3 Height Stationing

Case 2: No station is available. Go to 11.3 Height Stationing.

(5) P.I. input

ENT: Starts the mode

Enter the point identification in line 2 of Fig. 10.4.5.

```

Input P.I.      Measure point P1: ENTER
ih  1.650m
th  1.500m  <-----C-----><-----I----->
CIC CI I Ino R-C Ecc Inf D&H Mrk Con
  
```

Fig. 10.4.5: Input menu for local system

(6) Measurement to the first line point P1

Sight the reflector of the first point and initiate measurement with ENT or ENTER.

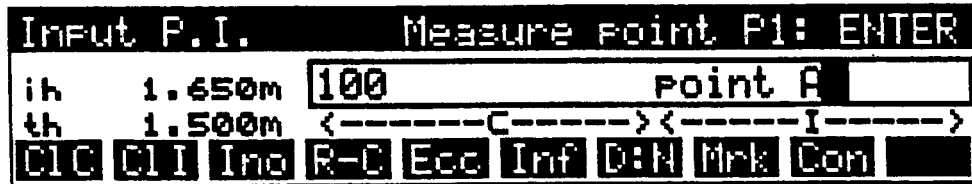

Fig. 10.4.6 Measurement to first line point

After the measurement the values are recorded corresponding to the setting of soft key 4 - R-M, R-C or RMC. Continue with (5). The original measured values D, HZ, V are displayed in the Elta display.

(7) Measurement to the second line point

Enter the point identification for the second point in line 2. Sight the reflector of the second point and initiate measurement with ENT or ENTER. Recording and display according to the first line point.

(8) Result menu



The original measured values D,HZ,V appear in the Elta display. All changes of the angles (Hz and V) are displayed continuously. Results after measurement to the two line points (Fig. 10.4.7):

- Line 2: Local coordinates y (easting), x (northing) and h (height difference) of the second line point referred to the P1-P2 axis and on the starting point P 1(Fig. 10.1.4).
- Line 3: Local coordinates of the station referred to the line P1-P2.

ENT: Storage in two Mem records if the recording mode is active and jump to (4)..

P1-P2/STATION		ENTER
y	0.000 x	4.487
y	2.355 x	4.612 Z
		-0.683

Fig. 10.4.7: Result menu of point-to-line distance

If P1 and P2 are identical, a message appears in the display (see 10.4.8). Continue measurement with ENT and proceed with (3.1.3).

```

Measuring !!
Add.  213
P1 and P2 are identical !
  
```

Fig. 10.4.8: Identical points

(9) Measurement of lateral points

Change from the result menu to the input menu for measuring detail points (points that are not on the line) with ENT.

The cursor in line 2 of the input field requests input of the new P.I.

For further measurements repeat steps (6) and (7).

The local coordinates y, x and Z referred to the line are displayed and recorded (Fig. 10.4.9).

```

y      -1.333 x      1.231 Z      -0.047
Add.  211  101      Point C
th  1.500m  <-----C-----><-----I----->
CIC CI I Ino R-C Ecc Inf D:N Mnk Con
  
```

Fig. 10.4.9: Lateral points

(10) Recording

The measurements are recorded automatically if soft key 4 is R-M, R-C or RMC.

Recording successful: the address is displayed in line 2 in front of the P.I. input field.

Important: If soft key 4 is Rno, recording is off. The address is missing in line 2 in this case.

(11) Measurement termination

MEN: Direct return to the SPECIAL program.

2. Coordinate system

The last completed system is displayed.

Y	6534.750 X	7523.842 Z	503.458
m	1.000000 Om	182.6502 ih	1.650
1500 PP			YES NO
STATIONING CORRECT ?			<input checked="" type="checkbox"/> <input type="checkbox"/>

Fig. 10.4.10: Display of Last Station

Is the station correct?

YES: Continue with (12) Recall P1

NO: Jump to SPECIAL main menu (fig. 10.1.1)

(12) Recall P1 and P2

The coordinates of points P1 and P2 may be recalled from memory using softkeys 3-8, or entered manually.

Recall point P 1		ENTER
Add.	213	
Add.	1 MESSUNG/HZ-V/	
	Inf	LAd ?Ad ?Pt ?PI ?+

Fig. 10.4.11: Selection of points P1 and P2

ENT: Confirm the selection

(13) Result Menu

If the points P1 and P2 are correctly recalled or entered, the result will be displayed.

P1-P2/STATION		ENTER
y	0.000 x	6.871
Y	6534.750 X	7523.842 Z
		503.458

Fig. 10.4.12: Result menu for Point to Line distance

where:

- Line 2: Local coordinates y and x of the second line point, relative to the P1-P2 axis
- Line 3: Major coordinates Y, X and Z of the Standpoint in the reference coordinate system

ENT: The result will be stored. Continue with (9)
 Measurement of Lateral Points

If both points are identical, the relevant display will appear (fig. 10.4.8).

The logo for 'Geodesical' features the word in a bold, blue, sans-serif font. A light blue, three-dimensional ring or sphere is positioned behind the letter 'G', partially overlapping it.

10.5 Vertical Plane

(1) Purpose

Determination of coordinates by means of pure angle measurement on a vertical plane determined by points P1 and P2. Especially suited for measuring facades.

(2) Mode selection

Call the vertical plane mode with numeric key 7 in the SPECIAL program (see Fig. 10.1.1); automatic change to the initial menu of this measurement mode (see Fig. 10.5.1).

```

Special: Vertical plane      Start: ENTER
                               m 1.000000
D/T Sta Bat Com Ind Col
  
```

Fig. 10.5.1: Initial menu of vertical plane

(3) Height Stationing

All object point heights are related to the chosen reference system, normally NN-heights.

```

ELEVATION BY                EXIT: MEN
PREVIOUS STATIONING (ELEVATION ONLY)
┌   MEASURING FIRST POINT
└
  
```

Fig. 10.5.2: Select Height determination

MEN: Return to SPECIAL menu.

Key 1: Height stationing

Case 1: A station is already available.

```

                               Z      503.457
                               ih     1.650
1000
STATIONING CORRECT ?        YES NO
                               └   └
  
```

Fig. 10.5.3: Display of Last Station

Is this station correct?

YES: Continue with (4) P.I. input

NO: Jump to 11.3 Height Stationing

Case 2: No station is available. Jump to 11.3 Height Stationing.

(4) P.I. input

ENT: Starts the mode

Enter the point identification in line 2 of Fig. 10.5.4.

Input P.I.		Measure Point P1: ENTER	
ih	1.650m	[]	
th	1.500m	<-----C-----><-----I----->	
CIC	CI	Ind	R-C Ecc Inf D:L Mk Con

Abb.: 10.5.4 Input menu

Important:

The height result depends on the entered reflector height th. Enter the appropriate height before initiating measurement.

- th = 0 i.e. all heights refer to the reflector height of P1.
- th = Height of the reflector above a reference plane, i.e. all height information refers to this reference plane.
- th = MSL elevations, i.e. all height information is MSL elevations.

(5) Measurement to 1st point on the vertical plane

The plane coordinates y and x of the 1st point are automatically set to zero.

Sight the reflector at the 1st point and initiate measurement with ENT or ENTER.

Input P.I.		Measure Point P1: ENTER	
ih	1.650m	1 first point	
th	1.500m	<-----C-----><-----I----->	
CIC	CI	Ind	R-C Ecc Inf D:L Mk Con

Fig. 10.5.5: Measurement of vertical plane

The original measured values D, Hz, V are displayed in the Elta display. These values are recorded if the recording mode is active (soft key 4 is R-M, R-C or RMC)

The address of the recorded values is displayed in line 2.

(6) Measurement to 2nd point on the vertical plane

Enter the point identification for the second point in line 2.

Sight the reflector at the second point and initiate measurement with ENT or ENTER.

(7) Result menu

The computed values E, A and h for the 2nd point appear in the Elta display. All three values are displayed continuously.

Results after measurement to the two base points (Fig. 10.5.6):

- Line 2: Local coordinates y (easting), x (northing) and h (height difference) of the second point referred to the base P1-P2.
- Line 3: Local coordinates of the station referred to the base P1-P2.

Storage in two Mem records if the recording mode is active after pressing the ENT or ENTER key. Automatic branch to the input menu for object point measurement (7).

P1-P2/STATION			ENTER
y	0.000 x	4.486	
y	2.356 x	4.611 Z	503.457

Fig. 10.5.6: Result menu of vertical plane

If P1 and P2 are identical, a message appears in the display (see 10.5.7). Continue measurement with ENT and proceed with (5).

Measuring !!	
Addr.	23A
P1 and P2 are identical !	

Fig. 10.5.7: Identical points

(8) Measurement of object points

The cursor in line 2 of the input field requests input of the new P.I.. All further measurements to object points are pure angle measurements. The Elta displays changes continuously. The y, and Z values are displayed and recorded after measurement initiation with ENT or ENTER (see Fig. 10.5.8).

```

y      0.000 x      3.560 Z      509.766
Add.   228      2 window
th     1.500m  <-----C-----><-----I----->
CIC CI Ino R-C  Inf  Mrk Con

```

Fig. 10.5.8: Object points

(8) Recording

The measurements are recorded automatically if soft key 4 is R-M, R-C or RMC.

Recording successful: the address is displayed in line 2 in front of the P.I. input field.

Important: If soft key 4 is Rno, recording is off. The address is missing in line 2 in this case.

(9) Measurement termination

MEN: Direct return to the SPECIAL program.

 **Geodesical**

11. COORDINATES Program

11.1 Survey

Large-area surveys need a coordinate system as a frame.

The measured data is oriented in a coordinate system for processing in the office when you use the MEASURE program modes.

However, in many applications it is necessary or desirable to create or use coordinates directly in the field. The modes required for this purpose are grouped in the COORDINATES program.

(1) Purpose

The COORDINATES program offers five modes (see Fig. 11.1.1) for determining, displaying and recording coordinates created in different ways, e.g. stationing on known or unknown points, that are required for side shots and for setting out.

(2) Measurement mode selection

Select the COORDINATES program with numeric key 8 in the main menu. This causes a change to the COORDINATE program menu (Fig. 11.1.1). The modes can be selected directly with the numeric keys assigned to the programs by the (L) symbols.

```
COORD: SELECT MODE          EXIT: MEN
STAT. KNOWN POINT          FREE STATIONING
  L  STAT. (ELEV.)         L  SIDE SHOTS
    L  SETTING OUT         L
      L
```

Fig. 11.1.1: Menu of the COORDINATES programs

(3) Description of the modes**Mode 1 Stationing on known point:**

Stationing by measurement to known backsight points (orientation) or by orientation with a given azimuth.

Mode 2 Elevation stationierung:

Height determination by measurement to known backsight points (free elevation stationing).

Mode 3 Setting out:

Setting out by coordinates or with azimuth and distance after prior stationing.

Mode 4 Free stationing:

Stationing by measurement to known backsight points for unknown station coordinates.

Mode 5 Side shots:

Determination of coordinates by measuring D, HZ, and V after stationing or in a local coordinate system.

Geodesical

11.2 Stationing on known point (orientation)

(1) Purpose

Preparatory measurement for orienting the set of directions or the circle, to determine the coordinates of side shots, or to set out coordinated points. The coordinates of the station and the backsight point or the azimuth to the backsight point are known.

Orient the instrument in the coordinates system by measuring to known reference points. The direction angle from the station to the reference points and the scale are computed from these measurements (Fig. 11.2.1).

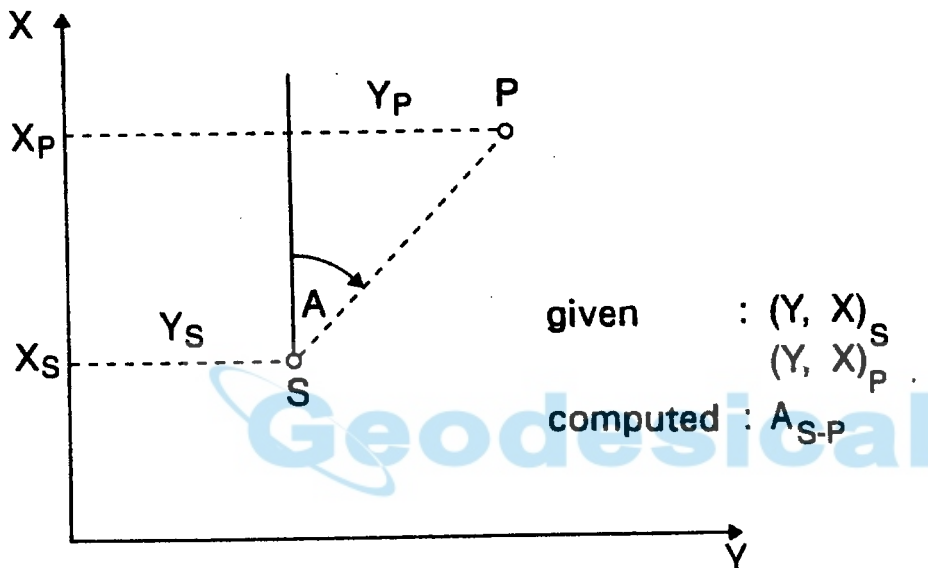

Fig. 11.2.1: Stationing on known point

(2) Mode selection

Call the stationing mode with numeric key 1 in the COORDINATES program (Fig. 11.1.1); automatic change to the initial menu of this measurement mode (see Fig. 11.2.2).



Fig. 11.2.2: Initial menu of stationing

It is stated in the entrance menu that all distance measurement is done with scale 1.00 independent of any other setting in the INPUT menu.

(3) Recall of known station

ENT: Starts the mode (Fig. 11.2.3).

The station can be recalled with soft keys 5 to 8 or entered manually with soft key 3.

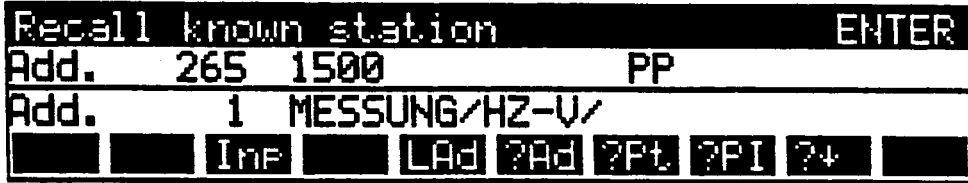

Fig. 11.2.3: Station call

Key	Function
FCT + 3 Soft key Inp	Manual input of P.I. and coordinates of the station as in the EDITOR program.
FCT + 5 Soft key LAd	Calls the last address in line 2.
FCT + 6 Soft key ?Ad	Calls the station by address.
FCT + 7 Soft key ?Pt	Calls the station by point number.
FCT + 8 Soft key ?PI	Call by point identification.
FCT + 9 Soft key ?↓	Further searching with the same searching mask
▲ , ↓	Scrolls in records.
▶ , ◀	Toggles between coordinates or point identification (P.I.) display.

With the searching functions ?Pt, ?PI and ?↓ you always search from address 1, independent of the actual address.

The found address is displayed in line 2 of Fig. 11.2.4.

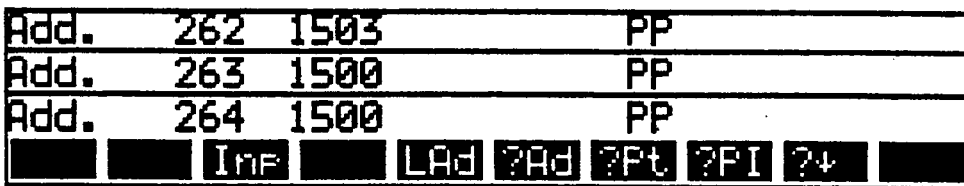

Fig. 11.2.4: Station call

ENT: Confirms point selection; program changes to the display in Fig. 11.2.5.

A message appears if the called address does not contain any coordinates.

(4) Orientation method

The orientation can be determined by two methods. Select with numeric key 1 or 2 in Fig. 11.2.5.

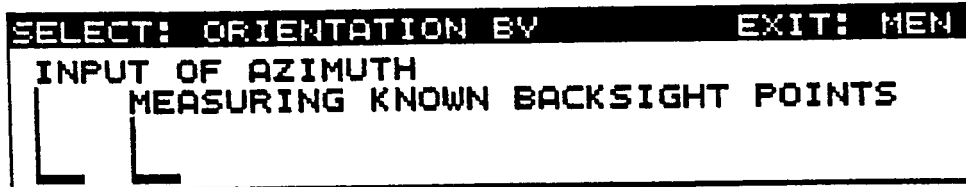

Fig. 11.2.5: Orientation options

Key 1: Distance measurement to the backsight point is not possible, but the direction angle between the station and the backsight point is known (e.g. computed from coordinates) and can be entered (see (6)).

Key 2: The coordinates of the backsight points are known (available in the memory or entered manually (see(9))).

Case 1: Orientation with known azimuth

(5) Set HZ menu

Key 1 in Fig. 11.2.5 requests entry of the direction angle (Fig. 11.2.6). Entry as in chapter 9.7, Set HZ Mode.

ENT: Terminates input and changes to P.I. input in the measure menu.

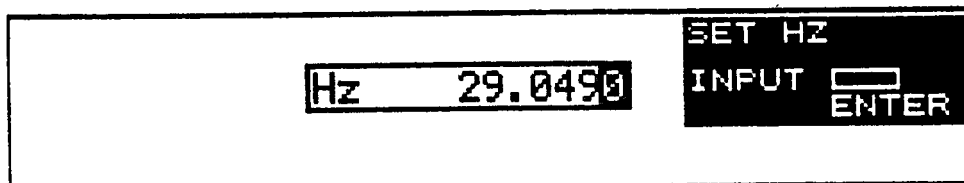

Fig. 11.2.6: Azimuth input

(6) P.I. input in the measure menu

ENT: Calls the measure menu (see Fig. 11.2.7); enter the point identification in line 2

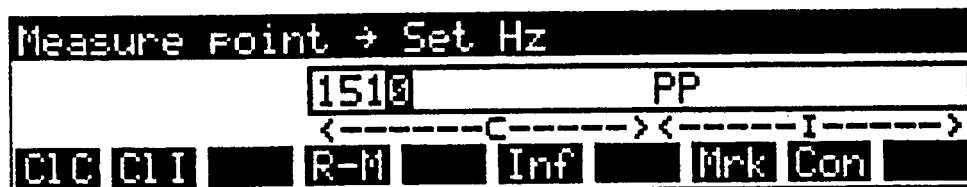

Fig. 11.2.7: P.I. input in the measure menu

(7) Measurement

ENT: Sight the backsight point and initiate measurement. The current station is displayed (see Fig. 11.2.8)

Y	6534.749X	7523.841 Z	503.458
M	1.000000 Om	35.6560	YES NO
STATIONING CORRECT ?			<input type="checkbox"/> <input type="checkbox"/>

Fig. 11.2.8: Stationing query

YES: - Storing of the station result (see (8))

- The HZ display in the Elta is set to the entered direction angle.

NO: - Change to the menu of the coordinate programs (Fig. 11.1.1).

(8) Recording

The set direction angle, the scale ($M = 1$) and the station coordinates are recorded.

Case 2: Orientation with backsight points

Steps (2) to (4) are similar.

(9) Backsight point recall

If you press key 2 in Fig. 11.2.5, the display changes to Fig. 11.2.9 for recalling the stationing backsight points from the Mem. There are maximal 20 backsight measurements possible to maximal 20 reference points.

Recall backsight point		1	ENTER
Add.	263	1500	PP
Add.	264	1500	PP
<input type="checkbox"/>	<input type="checkbox"/>	Inp	<input type="checkbox"/> LAd <input type="checkbox"/> ?Ad <input type="checkbox"/> ?Pt <input type="checkbox"/> ?PI <input type="checkbox"/> ?+

Fig. 11.2.9: Recall of backsight points

Calling the backsight points is similar to step (3)

Station recall with soft keys Inp, LAd, ?Ad or with the vertical cursor keys.

ENT: Confirms proper point selection; simultaneous change to the measure menu (Abb 11.2.11).

Fig. 11.2.10 appears if the station and the backsight point are identical.

ENT: Continue measurement and proceed with (9).

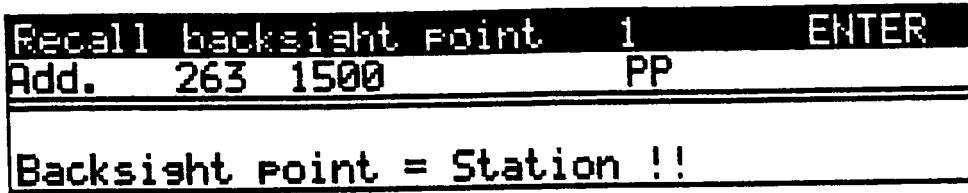

Fig. 11.2.10: Identical points

(10) Measurement

Sight the reflector at the backsight point and initiate measurement with ENT or ENTER.

Select the DTh or Th measurement mode by pressing soft key DTh, i.e. select the measurement option.

- DTh: Measurement with rangefinder and theodolite.
 Interrupt measurement with MEN and set soft key to Th if you inadvertently measured the target without prism.
- Th: Measurement only with the theodolite.
 The Elta only shows HZ and V; the D display is missing.



Fig. 11.2.11: Measure menu

(11) Result menu

After backsight measurement, the deviations between the measured values and the values computed from the coordinates (Fig. 11.2.12) are displayed in line 1.

Display of:

- dl = Longitudinal deviation if measured with DTh
- dq = Lateral deviation
- dz = Elevation deviation if the station elevation and the backsight point elevation are known.

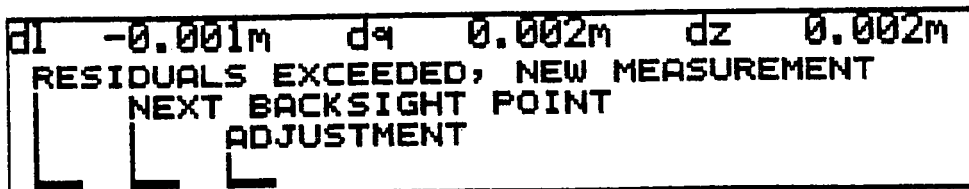

Fig. 11.2.12: Result menu

Measurement continuation depends on whether the given limits have been exceeded or not.

Meanings:

- Deviation too large, new measurement

The last measurement is not recorded and not used. Branch to (9), Backsight point recall

- Next backsight point

Recall further backsight points. Branch to (9), Backsight point recall

- Adjustment

Orientation computation

(12) Adjustment

If you select the adjustment option, the program computes the orientation and the scale and displays the residuals in the longitudinal and lateral directions (see Fig. 11.2.13). The same weights are used for averaging the backsight directions for orientation.



```

dl      0.001 d4      -0.002
1502    PP          SELECT: ↑↓
NO. 1    ALL RESIDUALS CORRECT: ENTER
Del     ADD  R-C
  
```

Fig. 11.2.13: Residuals display

Use the \uparrow up and \downarrow down cursor keys to access the individual residuals for assessing.

For soft keys Del and Add see 11.5 (6).

ENT: All residuals OK; automatic change to the scale menu

(13) Scale menu

The scale to be used for further measurements can be selected according to Fig. 11.2.14 after stationing completion. The selected scale is

- entered in the INPUT program,
- stored, and
- used for later computations.

SELECT: SCALE FACTOR	EXIT: MEN
SET IN INPUT MENU	:M 1.000125
COMPUTED (STATION.)	:M 0.999869
RESET TO	:M 1.000000

Fig. 11.2.14: Scale menu

- Key 1: Scale entry in the INPUT program
 Key 2: Use of the scale computed during stationing
 Key 3: Setting of the scale $M = 1.000\ 000$.

Branch to the result menu (15) by pressing one of the three keys if the station elevation is known; otherwise branch to the elevation computation menu (14).

(14) Elevation computation

If elevations are required for further measurements with the side shot or setting-out programs, the elevation must be computed.

<p>Compute elevation ?</p> <p style="text-align: right;">YES NO</p>

Fig. 11.2.15: Elevation computation

- No:
- No computation of the station elevation if it is unknown
 - No elevation computation in the side shot mode
 - No computation of elevation differences for setting-out
- Branch to the result menu (15)

Yes:

Case 1: The measured backsight points comprise elevations.

The program computes the station elevation from the backsight measurements as described in 11.3 Elevation Stationing, (5) Adjustment.

Case 2: The measured backsight points do not contain elevations.

Additional points must be recalled for elevation stationing. See 11.3 Elevation Stationing, (3) Backsight point recall.

(15) Result

After stationing, the complete result is displayed (see Fig. 11.2.16).

Y	6534.749X	7523.841Z	503.458
m	0.999869 Om	0.0313	YES NO
STATIONING CORRECT ?			<input type="checkbox"/> <input type="checkbox"/>

Fig. 11.2.16: Stationing result

YES: - Storage of the stationing result (see (16) 3. + 4.)

- The Hz display of the Elta is set to bearing angles.

NO: - Branch to the main menu; old stationing is retained

(16) Recording

Storage according to the selected soft key.

Soft key RMC stores both measured and computing values:

- 1.: Measured values D, HZ, V (directly after the confirmation of the residuals (Fig. 11.2.12)) The measurements used for elevation computation are stored again in a separate block.
- 2.: Computed values dl, dq, dz (dl, dq after orientation computation, dz after elevation computation).
- 3.: Coordinates Y, X, Z of the station
- 4.: Scale M and elevations ih (instrument) and th (reflector)

Soft key R-C stores items 2. to 4.

Soft key R-M stores items 1., 3. and 4.

Caution:

3. and 4. are always stored, also for Rno.

The recording is made in several parts, not in one block.

11.3 Elevation Stationing

(1) Purpose

Elevation stationing allows the elevation above MSL to be determined independently of plane stationing. In particular, the absolute elevation can also be measured in programs using a local coordinate system (e. g. object height or vertical plane). 20 backsight measurements are possible.

Note:

The following formula is used for weighting: $P = \text{const}/s^2$. For distances ≤ 30 m, the same weight is used.

(2) Mode selection

Call the elevation stationing mode with numeric key 2 in the COORDINATES program (see Fig. 11.1.1); automatic change to the initial menu of this measurement mode (see Fig. 11.3.1).



Fig. 11.3.1: Initial menu of elevation stationing

It is stated in the entrance menu that all distance measurement is done with scale 1.00 independent of any other setting in the INPUT menu.

ENT: Starts the menu and changes to the input menu for station identification (see Fig. 11.3.2).

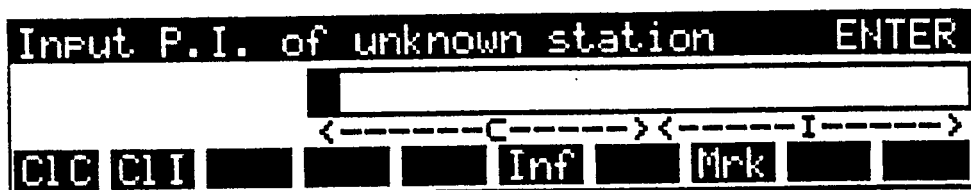

Fig. 11.3.2: Station entry

ENT: Confirms input and changes to the backsight point recall menu.

(3) Backsight point recall

In the recall menu, you can recall backsight points from the Mem with soft keys 3 to 8 (see 15., EDITOR Program), or enter them manually (see Fig. 11.3.3).

```

Recall elevation point 1          ENTER
Add.  281  1
Add.   1  MESSUNG/HZ-V/
[ ] [ ] INF [ ] LAd ?Ad ?Pt ?PI ?+ [ ]
  
```

Fig. 11.3.3: Backsight point recall

Note:

If you enter points manually, only the elevation (Z) is required because the distance to all points has to be measured. Z = 0.000 means no elevation.

The instrument or target elevation can be entered or modified with the INP key.

ENT: Confirms selection and changes to the measure menu (see Fig. 11.3.4).

```

Measure to elevation point 1 :ENTER
ih  1.650m  1502          PP
th  1.500m  <-----C-----> <-----I----->
[ ] [ ] [ ] R-M [ ] [ ] D:N Mrk Con [ ]
  
```

Fig. 11.3.4: Measure menu

ENT: Initiates measurement

(4) Backsight measurement result

The following selection menu appears after measurement completion:

```

dz -0.008m
RESIDUALS EXCEEDED, NEW MEASUREMENT
┌───┐
│   │ NEXT BACKSIGHT POINT
│   │ ADJUSTMENT
└───┘
  
```

Fig. 11.3.5: Selection after backsight measurement

where:

- dz 0.003

is the residual to the 1st backsight point
(for the first measurement, dz is always 0.000)

- Residual too large, new measurement

The last measurement is not recorded and not used,
branch to (3)

- Next backsight point

Recall of further backsight points,
branch to (3)

- Adjustment

Adjustment completion

Repeat steps (3) and (4) for all backsight points.

(5) Adjustment

If you select the adjustment option, the program computes the station elevation and displays the residuals to the backsight points (see Fig. 11.3.6).

```

Coord: Stat. elevation Start: ENTER
                                     S = 1.000000!
D/T Sta Bat Com Ind Col
  
```

Fig. 11.3.6: Residuals display

Use the ↑ up and ↓ down cursor keys to access the individual residuals for assessment. If all residuals are OK, confirm with ENT. The individual residuals are then recorded. In the Rec, the computed elevation appears together with the associated mean error (see Fig. 11.3.7).

```

                                     Z      503.456
                                     mZ     0.004
1550
STATIONING CORRECT ?      YES NO
                             |  |
  
```

Fig. 11.3.7: Adjustment result

- YES: Brief display of the address at which the result is stored and branch to the COORDINATES program
- NO: No result storage, branch to the main menu

(6) Adding and deleting

If the residuals in (3) are not OK, you can delete the corresponding measurements with soft key Del.

ARE YOU SURE ?	
YES	NO

Fig. 11.3.8: Deletion query

- NO: Branch to (5) Adjustment
- YES: Measurement deletion (see Fig. 11.3.9)

1503	P	- deleted -	dz	0.237
NO. 2	ALL RESIDUALS CORRECT: ENTER			
Del	Add	R-C		

Fig. 11.3.9: Measurement deleted

If you delete individual measurements, the adjustment is automatically repeated after ENT.

The deleted measurements are retained in the Mem. They are marked with DEL within the P.I.

Measurements can be added with soft key Add; branch to (3) Backsight point recall.

11.4 Setting Out

(1) Purpose

Locating or setting out coordinated points.

Stationing on a known station or free stationing, and storage in the Mem of the coordinates of the points to be set out are required for setting out by coordinates.

After memory input or recalling the point to be set out from the memory and measurement to the approximate point, the Rec Elta displays the longitudinal deviation dl , the lateral deviation dq , the radial deviation dr and the coordinate deviations dx , dy and dz (see Fig. 11.4.1).

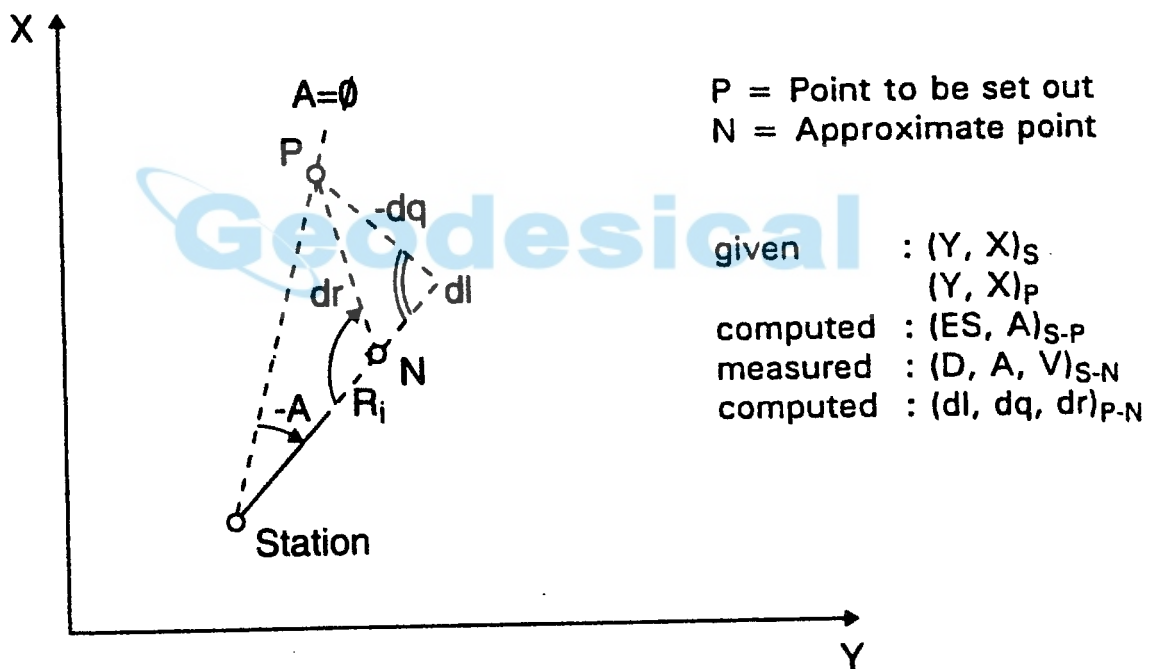

Fig. 11.4.1: Setting out

(2) Mode selection

Call the setting-out mode with numeric key 3 in the COORDINATES program (see Fig. 11.1.1); automatic change to the initial menu of this measurement mode (Fig. 11.4.2).

Coord: Settings out		Start: ENTER	
		m 0.999869	
<input checked="" type="checkbox"/> T	Sta	Bat	Com
Ind	Col		

Fig. 11.4.2: Initial menu of setting out

(3) Stationing query

ENT: Starts the mode

The results of the last stationing (coordinates, scale and orientation) are displayed for checking (Fig. 11.4.3).

Y	6534.749X	7523.841Z	503.458
m	0.999869 Om	0.0206 ih	1.650
1500	PP		
STATIONING CORRECT ?			YES NO

Fig. 11.4.3: Stationing query

- YES: Stationing is valid for this station
 Simultaneous change to the selection menu (Fig. 11.4.4) for selecting the setting-out method
- NO: Stationing is invalid for this station
 Simultaneous change to the **COORDINATES** program (Fig. 11.1.1) for stationing.

(4) Selecting the setting-out method

Two different setting-out methods can be selected according to Fig. 11.4.4.

- Key 1: Setting out with given coordinates Y, X, Z and orthogonal corrections dl, dq and dr or coordinates corrections dy, dx and dz, and simultaneous change to the setting-out point recall menu (Fig. 11.4.5).

Key 2: Side shots with given distance E, direction angle HZ and elevation difference h, if these values have been computed beforehand from the station and the setting-out coordinates. Simultaneous change to the setting-out point recall menu (Fig. 11.4.5).

```

SELECT: SETTING OUT          EXIT: MEN
COORDINATES: Y X Z
DISTANCE AND AZIMUTH: E HZ H
  
```

Fig. 11.4.4: Selection of the setting-out method

(5) Setting-out point recall

The setting-out point can be recalled with soft keys 5 to 8 or be entered manually with soft key 3 (fig. 11.6.5).

For setting out by coordinates, records with Y, X, Z values are recalled. For side shots, the E, HZ, (h) elements are retrieved.

```

Recall point to be set      ENTER
Add.  287 1503              PP
Add.   1 MESSUNG/HZ-V/
Inp  LAd ?Ad ?Pt ?PI ?↓
  
```

Fig. 11.4.5: Recall off setting-out points

Key	Function
FCT + 3 Soft key Inp	Manual entry of P.I. and station coordinates similarly to 15.3 of the EDITOR program. At the moment the data lines E, Hz(h) can't be entered manually.
FCT + 5 Soft key LAd	Recalls the last address in line 2.
FCT + 6 Soft key ?Ad	Recalls the setting-out point by address.
FCT + 7 Soft key ?Pt	Recalls the setting-out point by point number.
FCT + 8 Soft key ?PI	Recall by point identification.
FCT + 9 Soft key ?↓	Further searching with the same searching mask
↓ , ▲	Scrolls in the records
▶ , ◀	Toggles between coordinates or point identification (P.I.) display.

ENT: Confirms point selection and changes the display to Fig. 11.4.7. A message appears if after ?Ad or LAd the recalled address does not contain coordinates or side shot elements.

Check for identity of the setting-out point and the station.

Fig. 11.4.6 appears if the station and the setting-out point are identical.

MEN: Continue with (5) recall of the setting-out point

```

Recall point to be set          ENTER
Add.  263 1500                PP
-----
Point to be set = Station !!
  
```

Fig. 11.4.6: Identical points

(6) Setting-out elements

From the known station and target coordinates, the Rec Elta computes the setting-out elements E (wanted horizontal distance) and HZ (direction angle to the setting-out point) and displays them (see Fig. 11.4.7).

In the tracking mode, the Elta displays the angle (A) through which the Elta has to be turned to reach the wanted direction ($A=0$).

```

E          5.004 Hz          1.5369 Hz+0 :ENTER
ih  1.650m  1502          PP
th  1.500m
-----
R-C den Ang D:N Con
  
```

Fig. 11.4.7: Setting-out elements

ENT: Initiates measurement to the approximate point

(7) Measurement and result

```

Next iteration          ENTER
dl  0.000 dy  -0.014 dr  0.014
dy  -0.014 dx  0.000 dz  -0.019
-----
R-C den Ang D:N Con
  
```

Fig. 11.4.8: Result menu

After measurement completion, the rectangular and polar corrections are displayed.

Rectangular corrections dy , dx , dz as coordinate differences between the wanted point and the approximate point.

Polar corrections dl (longitudinal deviation), dq (lateral deviation) and dr (radial deviation).

- dl positive: Measured distance too short
- dq positive: Approximate point is left of wanted point

The Elta displays the lateral deviation in degrees (A) in the tracking mode. Repeat measurement to the approximate point with ENT until the deviations do no longer exceed the given limits.

With softkey 6 (Wno /Won) optionally the angle Ri in the approximate point can be displayed between station and nominal point (see fig.) By using the radial deviation dr and the angle Ri , the nominal point can be determined in respect to the approximate point with the set-out device ASG.

(8) Measurement termination and recording

MEN: Terminates the setting-out of the current point.

Brief display of the address at which the final setting-out elements are stored. The display changes to the recall menu (Fig. 11.4.5); repeat steps (5) to (7) if you want to set out further points.

Recording of the measurement elements or the setting-out result depends on the setting of soft keys 4 and 5:

- R-M: Measured values D , HZ , V
- R-C: Computed values depending on the setting of soft key 5:
 - dlq : Longitudinal, lateral and radial deviation
 - dyx : Coordinate differences dy , dx , dz
 - YXZ : Actual coordinates
 - ALL: All
- RMC: Measured and computed values

For a clear description which point has been set out, the address of the setting-out point is stored in the P.I. right justified.

The angle Ri is not recorded.

11.5 Free Stationing

(1) Purpose

With free stationing, the coordinates and the elevation of an unknown station can be determined in any coordinate system. Computation is by least squares adjustment. There are maximal 20 backsight measurements possible to maximal 20 reference points.

Plane and elevation adjustment are performed separately, and different backsight points may be used.

The backsight points can be measured with direction and distance, only with directions, or with a combination of the two.

The weighting ratio between direction and distance is 100 : 1. This corresponds to the following mean errors, for example:

$$\begin{aligned} m_{Hz} &= 0.0005 \text{ grads} \\ m_s &= 0.005 \text{ m} \end{aligned}$$

The weighting ratio can be influenced only indirectly by measuring a point repeatedly.

(2) Mode selection

Call the free stationing mode with numeric key 6 in the COORDINATES program (see Fig. 11.1.1); automatic change to the initial menu of this measuring mode (see Fig. 11.5.1).



Fig. 11.5.1: Initial menu of free stationing

ENT: Starts the mode and changes to the input menu for the station identification (see Fig. 11.5.2).

It is stated in the entrance menu that all distance measurement is done with scale 1.00 independent of any other setting in the INPUT menu.

```

Input P.I. of unknown station  ENTER
          1500 PP
          <-----C-----> <-----I----->
ClC ClI  Inf  Mrk
  
```

Fig. 11.5.2: Station entry

ENT: Confirms the entry and changes to the menu for selecting the backsight points.

Note:

Is the station elevation (Z) also to be computed, the instrument and the target elevation h must be entered or modified with the INP key.

(3) Backsight point recall

In the recall menu you can recall backsight points from the MEM with soft keys 3 to 8 (see 15., EDITOR Program), or enter them manually (see Fig. 11.3.3).

```

Recall backsight point 1  ENTER
Add. 231
Add. 1 MESSUNG/HZ-U/
Inf LAd ?Ad ?Pt ?PI ?↓
  
```

Fig. 11.5.3: Backsight point recall

(4) Measurement to backsight points

The backsight point can be measured after selecting it. After 2 measurements with direction and distance or 3 direction measurements, the program computes internal approximate coordinates. After measurement to the 2nd or 3rd and all following points, the following selection menu appears:

```

d1 -0.003 d4 0.000
1504 P - deleted - SELECT: ↑↓
NO. 4 ALL RESIDUALS CORRECT: ENTER
Del Add R-C
  
```

Fig. 11.5.4: Selection after backsight measurement

where:

- dl is the longitudinal deviation (only for distance measurement),
- dq is the lateral deviation,
- dz is the elevation deviation (Z) if the backsight point contains an elevation.

- Deviation too large, new measurement

The last measurement is not recorded and not used,
branch to (3)

- Next backsight point

Call further backsight points,
branch to (3)

- Adjustment

Adjustment completion

Repeat steps (3) and (4) for all backsight points.

(5) Adjustment

If you select the adjustment option, the program computes the plane coordinates, the scale and the circle orientation, and displays the residuals to the backsight points (see Fig. 11.5.5).

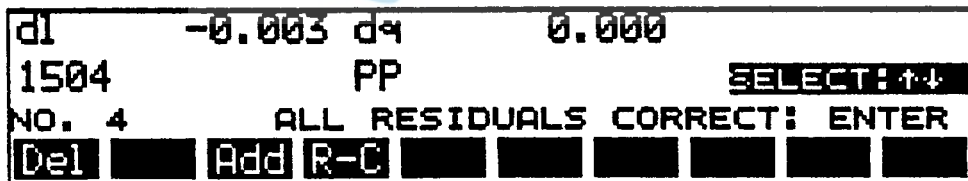

Fig. 11.5.5: Residuals display

Use the ▲ (up) and ▼ (down) cursor keys to select the individual residuals for assessment.

ENT: All residuals are OK,
branch to (7) Elevation computation

If the residuals are not OK, individual measurements can be deleted and added.

(6) Deletion and adding

If the residuals in (5) are not OK, the corresponding measurement can be deleted with soft key Del.

ARE YOU SURE ?	
YES	NO
<input type="checkbox"/>	<input type="checkbox"/>

Fig. 11.5.6: Delete query

NO: Branch to (5) Display of the old residuals

YES: Measurement deletion (see Fig. 11.5.7)

dl	-0.001	d9	0.000
	1501	- deleted	- SELECT: ↑↓
NO. 1	ALL RESIDUALS CORRECT: ENTER		
Del	Add	R-C	

Fig. 11.5.7: Measurement deleted

If you delete individual measurements, adjustment is repeated automatically after ENT. The deleted measurements are retained in the Mem and are marked with DEL within the P.I. Further measurement can be added with softkey Zus. Jump to (3), recall of the backsight points.

(7) Elevation computation

If elevations are required for further measurements with the side shot or setting-out programs, they must be computed.

Compute elevation ?	
YES	NO
<input type="checkbox"/>	<input type="checkbox"/>

Fig. 11.5.8: Elevation computation

NO: No computation of the station elevation
 No computation of elevations in the side shots mode
 No computation of elevation differences for setting out
 Branch to the result menu (8)

YES:

Case 1: The measured backsight points comprise elevations.

The program computes the station elevation from the backsight measurements as described in 11.3 Elevation Stationing, (5) Adjustment.

Case 2: The measured backsight points do not contain elevations.

Additional points have to be recalled for elevation stationing - see 11.3 Elevation Stationing, (3) Backsight point recall.

(8) Result

After stationing, the complete result is displayed (see Fig. 11.5.9).

Y	6534.749X	7523.841Z	503.458
mY	0.000 mX	0.000 mZ	0.000
m	1.000125 Om	0.0206	YES NO
STATIONING CORRECT ?			<input type="checkbox"/> <input type="checkbox"/>

Fig. 11.5.9: Stationing result

YES: - Storage of the stationing result (see (9))

- The Hz-display of the Elta is set to bearing angles.

NO: Branch to the main menu; the old stationing is retained

(9) Recording

Storage depends on the selected soft key.

Soft key RMC stores both measured and computed values:

- 1.: Measured values D, Hz, V (directly after confirmation of the residuals). The measurements used for elevation computation are stored again in a separate block. By this step a clear association of measurement and computation is made possible if here measurements are cancelled or further measurements are added.
- 2.: Computed values dl, dq, dz (dl, dq after orientation computation, dz after elevation computation).
- 3.: Coordinates Y, X, Z of the station
- 4.: Scale and elevations ih (instrument) and th (reflector)

Soft key R-C stores items 2. to 4.

Soft key R-M stores items 1., 3. and 4.

Caution:

Items 3. and 4. are always stored, also for Rno.

11.6 Side Shots

(1) Purpose

Determination of the coordinates and elevations of pass points by distance and angle measurement, display and recording of the computed values.

Coordinates computation is possible in a higher-level or a local coordinate system.

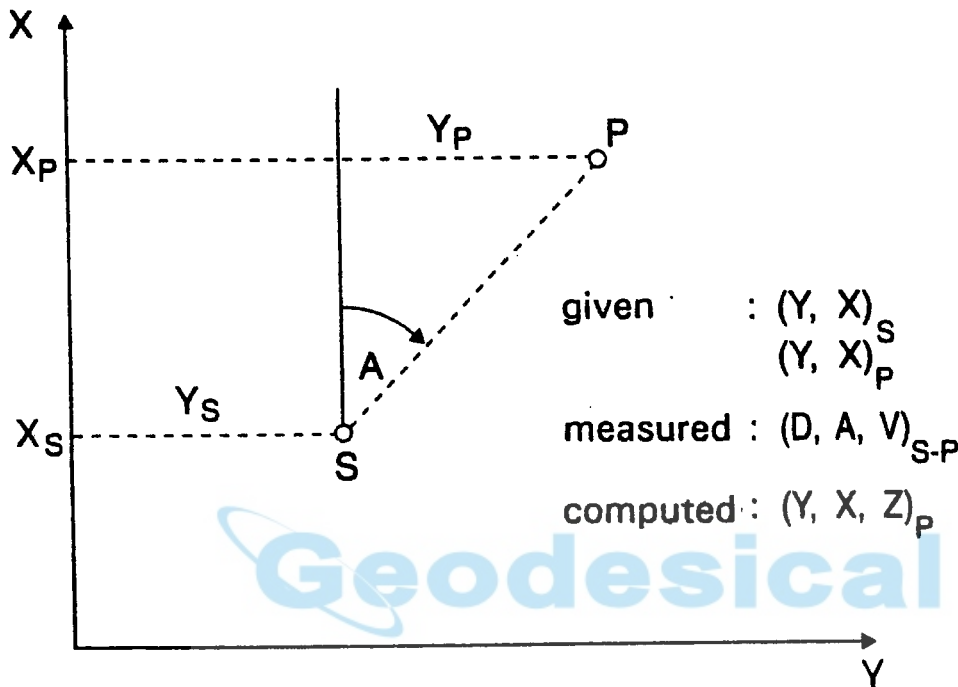

Fig. 11.6.1: Determination of the coordinates of pass points

(2) Mode selection

Call the side shot menu with numeric key 7 in the COORDINATES program (Fig. 11.1.1); automatic change to the initial menu of this measurement mode (Fig. 11.6.2).

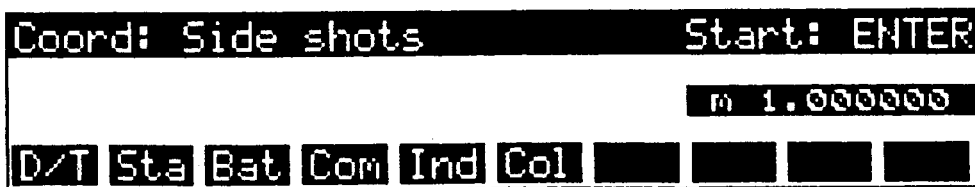

Fig. 11.6.2: Initial menu of side shots

ENT: Starting this mode

(3) Coordinate system selection

Choice between the determination of pass point coordinates in a (see fig. 11.6.3)

Key 1: local coordinate system
Key 2: higher-level coordinate system

SELECT: SYSTEM		EXIT: MEN	
LOCAL SYSTEM			
GRID SYSTEM (STATIONING)			

Fig. 11.6.3: Selection of the coordinate system

Case 1: Local system

The station is the coordinates origin ($y=0$, $x=0$), and the circle orientation and determines the North direction (northing x) of a local coordinate system. Direct change to the measure menu for P.I. input with numeric key 1 (Fig. 11.6.5).

Case 2: Coordinate system

For coordinates determination, stationing is required for orientation in the national system.

The results of the last stationing can be recalled with numeric key 2 for checking (see Fig. 11.6.4).

Y	6534.749X	7523.841Z	503.458
m	1.000000 Om	0.0206 ih	1.650
1500	PP		
STATIONING CORRECT ?			YES NO

Fig. 11.6.4: Stationing selection

- YES: Stationing is valid for this station
Simultaneous change to the measure menu (Fig. 11.6.5) for entering the P.I. of the first side shot
- NO: Stationing invalid for this station
Simultaneous change to the coordinate determination COORDINATES program (Fig. 11.1.1) for stationing.

(4) P.I. input in the measure menu

Enter the point identification of the pass point in line 2

Input P.I.		Measure point i :ENTER	
ih	1.650m		
th	1.500m	<-----C----->	<-----I----->
ClC	ClI	Ino	R-C Ecc Inf D:N Con ->2

Fig. 11.6.5: P.I. input in the measure menu

(5) Measurement

ENT: Initiates measurement to the pass point.

Input P.I.		Measure point i :ENTER	
ih	1.650m	5501	tree
th	1.500m	<-----C----->	<-----I----->
ClC	ClI	Ino	R-C Ecc Inf D:N Con ->2

Fig. 11.6.6: Measurement with side shot

(6) Result menu

After measurement completion, all three coordinate values are displayed in line 1 (Fig. 11.6.7).

The original measured values D, HZ, V appear in the Elta display.

The cursor in line 2 of the input field requests input of the new P.I. For further measurements repeat items (4) and (5).

Y	6536.180X	7530.717Z	504.247
Add.	293	5501	tree
th	1.500m	<-----C----->	<-----I----->
ClC	ClI	Ino	R-C Ecc Inf D:N Con ->2

Abb 11.6.7: Result menu

(7) Recording

Recording successful: an address is displayed in line 2 before the P.I. input field.

Recording of measurement elements or coordinates depends on the setting of soft key 4:

- R-M: Measured values
- R-C: Coordinates
- RMC: Measured values and coordinates

 **Geodesical**

12. Units

(1) Purpose

Selection of the units to be used for measuring.

(2) Program selection

Change from page 1 to page 2 of the main menu with key 0.

The numeric key 1 on page 2 of the main menu causes the display of the selection menu (Fig. 12.1).

ANGLE:	GRD	V-REF :	ZENITH	UNITS
DIST.:	METER	HZ-REV:	+	SELECT: ↑↓←→
TEMP.:	C	PRESS :	HPA/MB	ENTER
COORD:	Y X Z			

Fig. 12.1: Selection menu of UNITS

(3) Selection of the unit to be changed

Move the input field with the cursor keys ◀ (left), ▶ (right), ▲ (up) and ▼ (down).

MEN: Exit from the units menu

Storage of the new unit in the Mem if you selected a new unit.

Return to page 2 of the main menu

(4) Input activation

Confirm proper selection with ENT; simultaneous change to the editing menu (see Fig. 12.2).

ANGLE:	GRD	V-REF :	ZENITH	UNITS
DIST.:	METER	HZ-REV:	+	CHANGE ↑↓
TEMP.:	C	PRESS :	HPA/MB	ENTER
COORD:	Y X Z			

Fig. 12.2: Editing menu

(5) Entry editing

Press the vertical cursor keys ▲, ▼ until the desired measuring unit appears in the input field.

ENT: Entry of the new unit in the Elta NV-RAM.

Change to the selection menu (see Fig. 12.1).

MEN: The old unit is retained.

Change to the selection menu (see Fig. 12.1).

(5) Entry editing

Press the vertical cursor keys \uparrow , \downarrow until the desired measuring unit appears in the input field.

- ENT: Entry of the new unit in the Elta NV-RAM.
 Change to the selection menu (see Fig. 12.1).
- MEN: The old unit is retained.
 Change to the selection menu (see Fig. 12.1).

(6) Selection options**- Horizontal and vertical angle measurement Hz and V:**

Grads (400.0000)
DMS (360°00'00")
DEG (360.0000°)
Mil (6400)

- Distance measurement D:

Meters (m)
feet (ft)

- Temperature T:

°C
°F

- Pressure P:

hPa/mb (Hektopascal or millibar)
Torr
InMerc

- Coordinates:

Easting northing, and elevation
Y, X, Z
X, Y, Z
E, N, Z
N, E, Z → northing, easting, height
Direction angle: always ccw (from the northing)

- Vertical reference system V-Ref:

- Zenith angle
- Vertical angle
- Height angle
- % slope

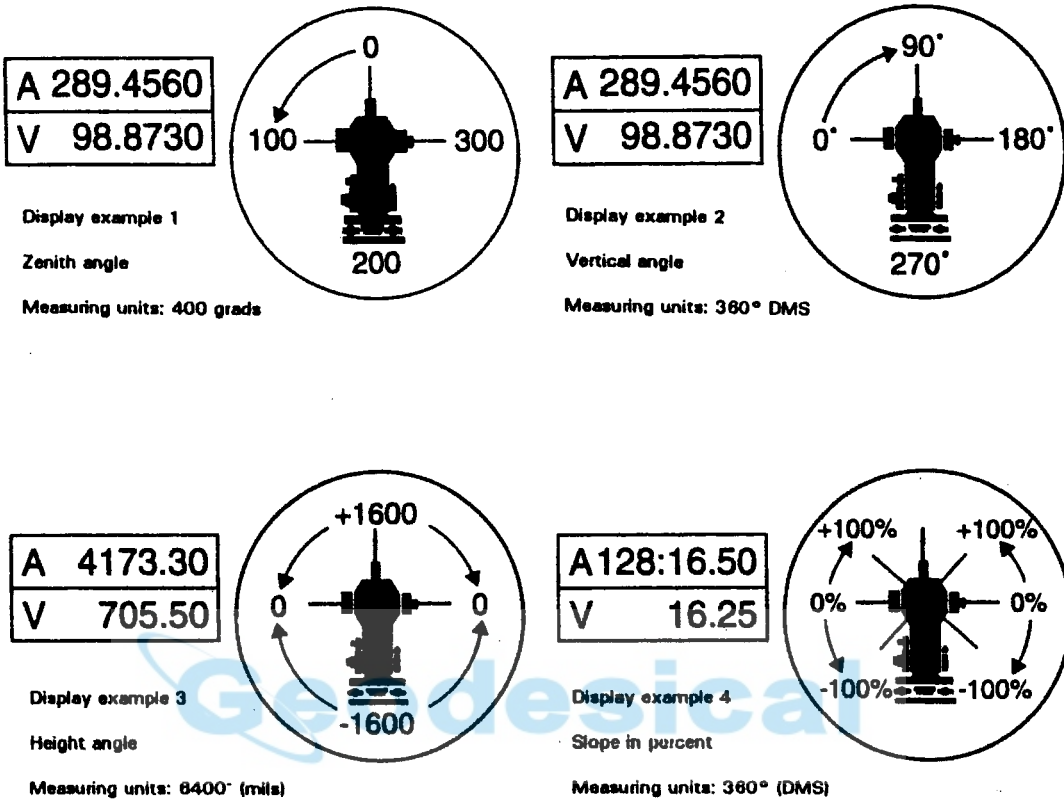

Fig. 12.3.: Vertical reference system

 **Geodesical**

13. Set

13.1 Survey

(1) Purpose

To identify a point or measurement for later processing, it has to be coded or described in detail.

In the SET program, the format of the point identification and, to facilitate input, a freely selectable marking can be set individually.

Depending on the application it may be useful to individually select the number of decimal digits for the measured and computed elements.

It may also be appropriate to record project information too and to protect the recorded data against modification.

(2) Set mode selection

On page 2 of the main menu, the SET program can be called directly with key 2. The initial menu of the SET programs with its options (Fig. 13.1.1) is displayed.

Use keys 1, 2, 3, 6 and 7 to directly select the modes.

```
SET: SELECT MODE           EXIT: MEN
MARKING                    PROJECT DESCRIPTION
  |                         |
  | DECIMAL DIGITS         | PC - DEMO
  |   PASSWORD            |
  |_____                |
  |_____                |
  |_____                |
  |_____                |
  |_____                |
```

Fig. 13.1.1: Initial menu of the SET program

(3) Mode description

Mode 1: MARKING

To identify and describe a measurement or a point, a point identification (P.I.) consisting of a point code and additional information (up to 27 characters) has to be entered before measurement.

To improve the readability of the 27 characters and to facilitate P.I. input, you can individually mark the input fields.

Mode 2: DECIMAL DIGITS

The number of decimal places for directions, angles or distances, coordinates and heights, can be selected.

Mode 3: PASSWORD

The measured or computed data can be protected against manipulation by entering a password.

Mode 6: PROJECT PROMPTS

Information on the current project increases the readability of the recorded data.

The entries for the PROJECT DATA program can be predefined in this mode.

Mode 7: PC-DEMO

The contents of the Rec E screen can be displayed on a PC terminal.

13.2 Marking

(1) Purpose

To increase the readability of the 27 characters and to facilitate P.I. input, you can individually mark the input fields. Freely selectable marks facilitate input. Up to 7 different marks can be used.

(2) Selection of the initial menu of Marking

Call the Marking option in the SET program with numeric key 1 (see Fig. 13.1.1); the display changes to the mark selection menu (Fig. 13.2.1)

```

MARKING: SELECT MODE          EXIT: MEN
DEFINITION
┌──┐ TRANSFER REC ELTA → MEM
├──┐ TRANSFER MEM → REC ELTA
└──┐

```

Fig. 13.2.1: Mark selection menu

To define individual marks, select the DEFINITION option with numeric key 1 (Fig. 13.2.1).

The mark information is stored in the Mem. It contains a default mark. Other marks are not set.

New marks entered in the Rec Elta must be transferred to all other Mem with the TRANSFER REC ELTA → MEM option (see Fig. 13.2.1). Doing this all data on the Mem are cancelled.

Transferring the mark information from one Rec Elta to another one is possible with the TRANSFER MEM → REC ELTA option by using the Mem as an intermediary.

(3) Default mark

When you select the DEFINITION option (key 1 in Fig. 13.2.2), the mark with the number 1 automatically appears in the display. In the delivery condition of the Rec Eltas, the default mark appears.

```

123456789012345678901234567 MARKING 1
<-----C-----><-----I----->
T P P P P P P P P P P P P P P P T
SELECT: ↑↓
ENTER

```

Fig. 13.2.2: Selection menu with default mark

Description of mark 1: Default mark - Rec 500 format

Line	Contents	Function
1	Column ruler Characters 1 to 27	Aid for precisely locating a character within the P.I.
2	Marking line	Subdivision of the P.I. into point code (C) and additional information (I).
3	Tab stops ENTER	Default tab stops in columns 1 and 15. Activates the input routine
4	Point number field	Specification of the point number field (default 1 to 14); marked by 14 Ps.
5	Soft keys	This line is not used when you select an option or a mark.

When you press the ENT key, soft keys appear in the line that afford modification of the tab stops and of the point number field.

Geodesical

13.2.1 Defining your own marks

(1) Purpose

Individual marks facilitate point identification input by their graphical representation.

Up to 7 different marks can be defined. In our works, the default mark is assigned to mark number 1. This can be edited whenever wanted.

When you access a mark with the cursor keys and activate input with the ENTER key, the default mark is set as a modification aid.

(2) Mark selection

Key Function

▲, ↓ Scrolling through all (set or blank) marks.

MEN Exit from the default mark menu and call of the MARKING selection menu (Fig. 13.2.1).

ENT Activates the input routine for the selected mark, which can then be modified.

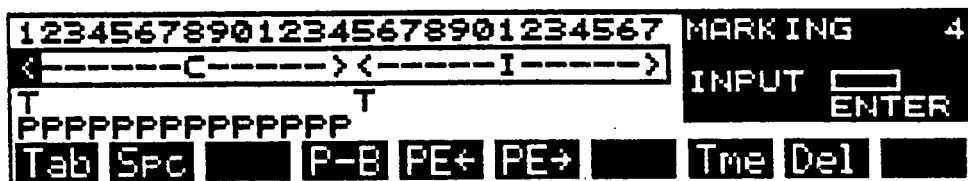

Fig. 13.2.1.1: Input menu for mark modification

You can now change this default mark according to your requirements.

(3) Entering your own mark

The following hard and soft keys support the entry of marks.

Key	Function
ABC	Activates alpha input for defining a mark; the soft keys in line 5 are replaced by the letters of the alphabet (see section 8.3.2).
◀, ▶	Select a given position in the input field with the horizontal cursor keys.
1, 2, ..., 0	Enter the mark with letters and special characters with the numeric keys.

(4) Setting tab stops (optional)

A random number of tab stops can be set.

Key	Function
-----	----------

◀ ◀,▶	Select the desired position.
----------	------------------------------

Softkey Tab A "T" (tab stop) is set in line 3 at this position.

The tab stop can be reset with the same soft key.

(5) Setting a space (optional)

This position cannot be selected during P.I. entry, i.e. it is skipped automatically.

The space is effective only within the additional information, not within the point number.

Key	Function
-----	----------

◀,▶	Select the desired position.
-----	------------------------------

Softkey Spc	The character " " appears in the mark line at this position. Any existing character is overwritten.
-------------	---

The space can be deleted again by overwriting with another character.

(6) Specifying the point number field

The point number field must always be specified.

In this field,

- incrementation is performed,
- point numbers are retrieved with ?Pt.

For specification, use the soft keys P-A for the beginning and PE→ or PE for the end of the field. The following bounds apply to the number of characters in the point number:

- | | |
|---|-----------|
| - Minimum size of the point number field: | 3 digits |
| - Maximum size of the point number field: | 14 digits |

Exceeding these bounds is not possible.

Key	Function
◀, ▶	Select the desired position.
Soft key P-A	A 3-digit point field begins at this position.
Soft key PE→	To increase the field size by one digit.
Soft key PE	To reduce the field size by one digit.

The specified field is marked in line 4 with at least 3 Ps and up to 14 Ps.

(7) Specifying the time field

Key Function

◀, ▶ Select the desired position.

Soft key Tme In line 4, the field is marked with HH:MM (hours, minutes).
The time can be changed by pressing the soft key again:

HH:MM.SS: Hours, minutes, seconds
HH:MM.SS.D: Hours, minutes, seconds,
1/10th second.

Another pressure deletes the time field.
If, after changing the cursor position, you press the soft key Tme again, the HH:MM mark is moved to this position.

If, after selecting the start position, there is not enough space for the desired time representation, it is right-justified, i.e. the first position moves to the left as required.

Note:

It is useful to include the mark number in the point information, for example, because it is not visible when you call the input menu. Entering one digit does not restrict information input (see Fig. 13.2.1.2).

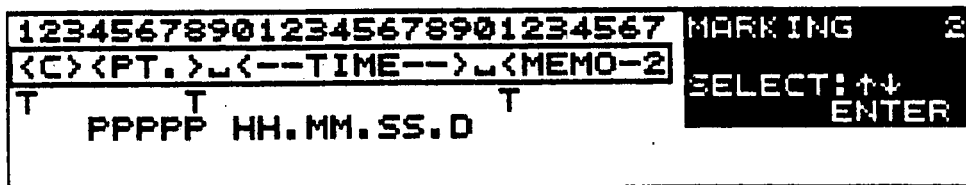

Fig. 13.2.1.2: User-defined mark with number

(8) Restrictions

The following specifications are mutually exclusive:

- Point number field and time field:
 - A time field may not be defined in a point number field.
 - A point number field may not be extended into a time field.
- Point number field and space:
 - Spaces in a point number field are automatically deleted after ENT.

(9) Storing the entry or modification

With the ENT key you can include the entered or edited mark in the list of marks. Exiting before storage is possible with the MEN key as in all other menus.

Key	Function
-----	----------

ENT	Exit from the Editor mode.
-----	----------------------------

Modification storage.

Call of the Fig. 13.2.2 selection menu for selecting the next mark.

MEN	Exit from the Editor mode.
-----	----------------------------

The modification is not saved, the old mark is retained.

Proceed with Fig. 13.2.2

(10) Deleting a mark

Marks that are no longer required can be deleted with soft key Del.

Key	Function
-----	----------

▲, ↓	Mark selection
------	----------------

ENT	Mark input activation
-----	-----------------------

Soft key Del	Fig. 13.2.1.3 is displayed.
--------------	-----------------------------

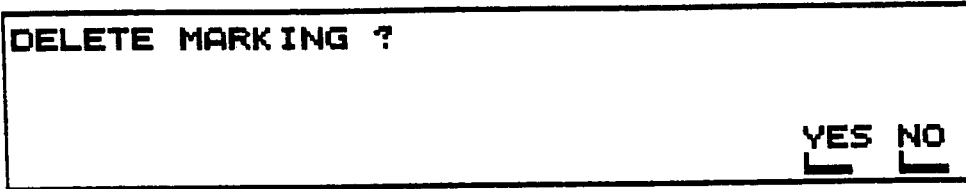

Fig. 13.2.1.3: Mark deletion

- 0 NO The mark is displayed again (Fig.13.2.2).
- 9 YES The mark is deleted; the display changes to Fig. 13.2.1.4

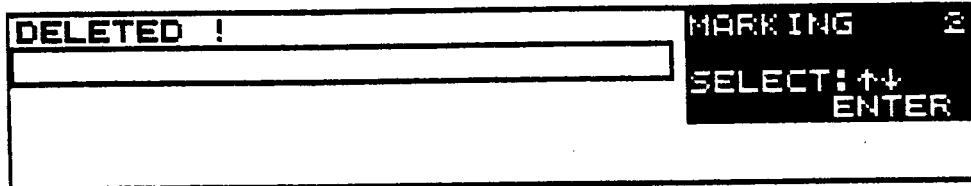

Fig. 13.2.1.4: Mark deleted

- ▲,↓ If you do not enter a new mark, this display appears as long as the cursor keys are pressed.
- ENT The default mark is set in the deleted mark to facilitate mark input.

(11) Marks for the Rec 200 record format

If you use the Rec 200 format for data processing, an appropriate mark may be useful for measurement. Fig. 13.2.1.5 shows an example.

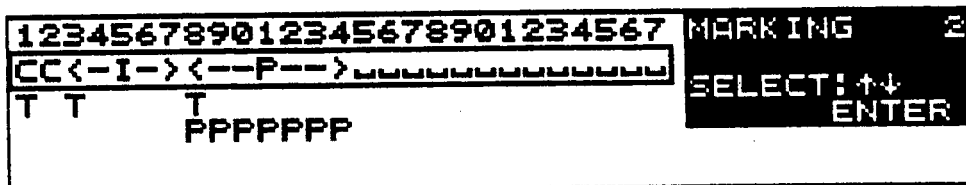

Fig. 13.2.1.5: Rec 200 format

Similar rules apply also to the Dac 100 data format. The Rec 200 format requires numeric input in the first 14 digits of the P.I. For data transfer in the Rec 200 format, see sections 19.5.2 and 19.6.1.2.

13.2.2 Mark transfer from the Rec Elta to the Mem

(1) Purpose

Before using a new Mem, you should transfer the current marks into it because it contains only the default mark in the delivery condition.

Also, when you modify marks, which is done with the Rec Elta, be sure to transfer the new marks to all Mem's to be used.

Since all data is deleted in the Mem during this operation, take care to save it, if required.

Any record stored in the Mem also contains the number of the associated mark - even though it is not visible - so that a unique relationship between the records and the different marks is established. For example, when you call a record (EDIT mode in the EDITOR program), the correct mark is used automatically.

When initializing the Mem, the marks set in the Rec Elta are automatically copied in the Mem.

Since the Mem is the storage medium for the mark information, marks set in the Rec Elta must be transferred to all Mem's.

In the measurement modes, you can select another mark directly with soft key Mrk. Blank or deleted marks are skipped. The mark information is always retrieved from the Mem.

(2) Menu selection

When you press key 2 in Fig. 13.2.1 (TRANSFER REC ELTA → MEM) the following display appears in confirmation:

```
TRANSFER OF MARKINGS
FROM REC E TO MEM ?
ALL DATA WILL BE DELETED !!!
                                     YES NO
                                          
```

Fig. 13.2.2.1: Mark transfer from the Rec Elta to the Mem

YES: Transfer of the marks; back to Fig. 13.2.1.
Caution: All data is deleted!

NO: Direct return to Fig. 13.2.1.

13.2.3 Mark transfer from the Mem to the Rec Elta

(1) Purpose

Transfer of Rec Elta marks to another Rec Elta is possible by using the Mem as an intermediary.

When you press key 3 in Fig. 13.2.1 (TRANSFER MEM → REC ELTA) the following display appears in confirmation:

<p>TRANSFER OF MARKINGS FROM MEM TO REC E ?</p> <p style="text-align: right;">YES NO <input type="checkbox"/> <input type="checkbox"/></p>
--

Fig. 13.2.2.2: Mark transfer from the Mem to the Rec Elta

YES: Transfer of the marks to the Rec

NO: Direct return to Fig. 13.2.1.

The logo for Geodesical, featuring the word "Geodesical" in a blue, sans-serif font. A blue orbital ring encircles the letter "G".

13.3 Decimal Digits

(1) Purpose

You can set the number of decimal places for the display of the angle and distance measurements in the Rec E. The decimal places of the Elta display are not affected by this.

Warning:

The internal storage in the Mem is always done with 5 digits for the angles and 4 digits for the distances. When transferring data Rec → peripheral device, the data is transferred with the chosen number of decimal digits.

(2) Mode selection

Call the DECIMAL DIGITS option in the SET program with numeric key 2 (see Fig. 13.3.1). Enter the password, if required.

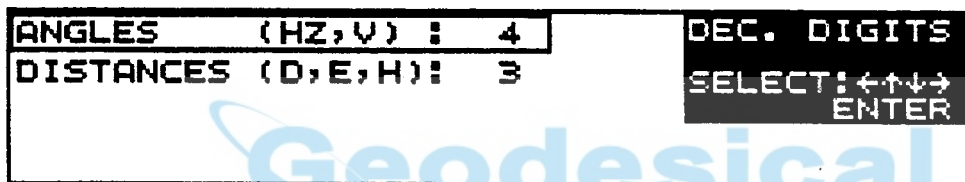

Fig. 13.3.1: Decimal digits mode

(3) Angle or distance selection

Select the decimal digits for angle or distance with the cursor keys ▲ (up) and ↓ (down).

MEN: Branch to the SET program.

ENT: The chosen mode is activated by the ENTER key.

(4) Modification

Select the desired mode with the ENT key (see Fig. 13.3.2).

ANGLES (HZ,V) :	4	DEC. DIGITS
DISTANCES (D,E,H):	3	CHANGE ↑↓
		ENTER

Fig. 13.3.2: Changing of decimal digits for angles

With the cursor keys ▲ (up) and ▼ (down), you can select 2 to 5 decimal digits in the angle mode and 2 to 4 decimal digits in the distance mode (see Fig. 13.3.3).

ANGLES (HZ,V) :	5	DEC. DIGITS
DISTANCES (D,E,H):	2	CHANGE ↑↓
		ENTER

Fig.13.3.3: Changing of the decimal digits for distances

ENT: The modification is saved.

(5) Modification termination

ANGLES (HZ,V) :	5	DEC. DIGITS
DISTANCES (D,E,H):	2	SELECT: ←↑↓→
		ENTER

Fig. 13.3.4: Changed decimal digits

MEN: Jump to SET program.

13.4 Password

(1) Purpose

Protection of specific menus or options against unauthorized modification.

The following programs or program parts are protected with a password:

- Units
- SET
 - Marks
 - Decimal digits
 - Password redefinition
 - Project data
- EDITOR
 - Soft key Edt
 - Delete options except DELETE ALL

(2) Mode selection

Call the PASSWORD option in the SET program with numeric key 3 (see Fig. 13.4.1).



Fig. 13.4.1 Selection menu

(3) Input

Case 1: No password set.

Select NEW DEFINITION. You can enter letters, digits and special characters in up to 7 positions (see Fig. 13.4.2).

With soft key CII you can delete existing or entered characters.

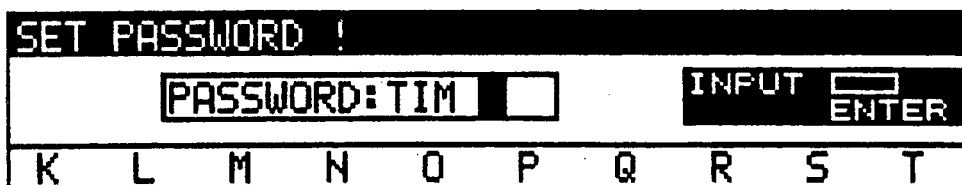

Fig. 13.4.2 Input

ENT: Confirms input; automatic return to the selection menu (see Fig. 13.4.1).

Case 2: A password is set and may be modified or deleted.

a: The password is unknown. Call the DELETE option (see Fig. 13.4.3).

The screenshot shows a terminal window titled "SELECT PROGRAM". It contains two columns of menu items. The left column has "PROJECT DATA" and "INPUT ADJUST". The right column has "MEASURE" and "SPECIAL COORDINATES". Below the menu items is a numeric keypad with buttons for digits 1 through 0. An arrow points to the number 2 in the right column of the menu.

Fig. 13.4.3: Deletion

YES: The set password is deleted. All protected functions are now freely accessible.

NO: Jump back to the selection menu (13.4.1)

b: The password is known and is to be modified. Call the NEW DEFINITION option (see Fig. 13.4.4).

The screenshot shows a dialog box titled "PASSWORD REQUIRED !". It contains a field labeled "PASSWORD: TIM" followed by a small square box. To the right is a field labeled "INPUT" with a small square box and the word "ENTER" below it. At the bottom of the dialog, there is a row of eight small square boxes, the first of which contains the letters "CI".

Fig. 13.4.4: Password entry

After entering the current password, you can define a new one (see case 1).

The existing password need be entered only once as long as you do not specify a new one and the Rec Elta remains turned on.

13.5 Project Prompts

(1) Purpose

The project data format can be predefined for the project data input program. A password may be required for input.

(2) Program selection

Numeric key 6 of the SET menu and password, if required (Fig. 13.5.1).

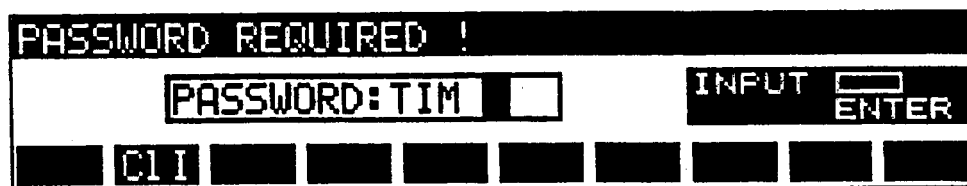

Fig. 13.5.1: Password entry

After password entry, you can define the individual project data lines (Fig. 13.5.2).



Fig. 13.5.2: Project lines display

The following project data lines are standard:

- Number 1 Project :
- Number 2 Task No. :
- Number 3 Observer :
- Number 4 Reflector :
- Number 5 Instr. No. :
- Number 6 Date :
- Number 7 Remark :

(3) Selection of individual project data lines

Select the project data line with cursor keys ↓ (down) and ▲ (up).

(4) Input or modification activation

ENT: Confirms proper selection (see Fig. 13.5.3).

PROJECT DESCR. LINE NO. 1										
Project :								INPUT		ENTER
A	B	C	D	E	F	G	H	I	J	

Fig. 13.5.3: Input of project lines

You can now modify the default setting according to your requirements.

Effective soft key:

CII Deletes the information

(5) Input or modification termination

ENT: Terminates input or modification (see Fig. 13.5.4).

PROJECT DESCR. LINE NO. 1										
Project :								SELECT: + + + +		ENTER

Fig. 13.5.4: Input or modification termination

Repeat steps (3) to (5) for the desired project data lines.

MEN: Options (fig. 13.5.5)

27 CHARACTERS IN PROJECT DATA ?	
YES	NO
<input type="checkbox"/>	<input type="checkbox"/>

Fig. 13.5.5: Project Data Selection

- NO:
- The defined project data lines will be supplied in the PROJECT DATA program as a prompt. 17 places in each line are still available for project descriptions.
 - Return to SET program.
- YES:
- All 27 places in each line are available for project descriptions. The definition from the Set mode may be overwritten.
 - Return to SET program.

13.6. PC-DEMO

(1) Purpose

The current screen contents on the Rec E can be displayed on a PC screen for demonstration purposes. In this way a system demonstration is possible even with a large audience.

(2) Mode selection

For the demonstration, the Rec E must be connected to a PC, e.g. with the cable 7081 77-9270 (see fig.19.3.3). The Carl Zeiss RECE_TRM.EXE must be running on the PC.

Now press the number key 7 in the SET menu.

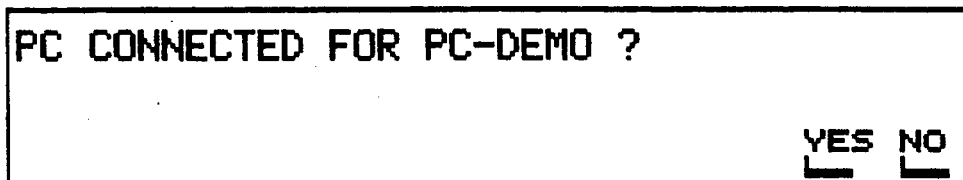

Fig. 13.6.1: PC-DEMO verification

NO: Return to menu 13.1.1

YES: All Rec E program menus will be displayed on the PC display. In addition, the displayed image of each key pressed will be briefly lit.

Warning:

Only press the YES key when the PC is connected and the RECE_TRMM program has been started, otherwise the Rec Elta will crash. The instrument can then only be switched off after the batteries have been removed.

During a demonstration with PC-DEMO, the reaction times on the Rec Elta are noticeably slower. The instrument can therefore not be used as quickly as is normal.

(3) Ending the PC-DEMO

The PC-DEMO mode can be exited in several ways:

1. Switch the Rec Elta off, then on again. The Rec Elta will then operate without PC-DEMO.
2. Select the PC-DEMO mode while in the demonstration mode. Press the NO key when asked for verification (fig. 13.6.1). The Rec Elta will then operate in its normal mode.

(4) Extra Information:

Further information on the operation of the RECE_TRM software on the PC may be obtained by using the command RECE_TRM /H.

The logo for Geodesical, featuring the word "Geodesical" in a blue, sans-serif font. A light blue, stylized orbital ring or path surrounds the letter "G".

The logo for 'Geodesical' features the word in a bold, blue, sans-serif font. A light blue, three-dimensional ring or sphere is positioned behind the letter 'G', partially overlapping it.

14. Switches

(1) Purpose

Activation and deactivation of functions and switch settings.

(2) Program selection

Change from page 1 to page 2 of the main menu with key 0.
 Numeric key 3 on page 2 of the main menu → Display of the selection menu (see Fig. 14.1).

```

COMPENSAT.: ON RECORD.: ON SWITCH
ILLUMINAT.: OFF SOUND : ON SELECT: ←↑↓→
AUTO(T/P) : ON ENTER
  
```

Fig. 14.1: Selection menu of Switches

(3) Selection of the switch to be changed

Move the input field with the cursor keys ◀ (left), ▶ (right), ▲ (up) and ▼ (down).

MEN: Branch to the main menu - page 2.

(4) Activation of the setting menu

ENT: Confirms proper selection of the switch to be set; simultaneous change to the setting menu (see Fig. 14.2), which displays the switch to be set in inverted form.

```

COMPENSAT.: ON RECORD.: ON SWITCH
ILLUMINAT.: OFF SOUND : ON CHANGE ↑↓
AUTO(T/P) : ON ENTER
  
```

Fig. 14.2: Setting menu

MEN: No modification, branch to (3).

(5) Switch setting

The vertical cursor keys ▲, ▼ toggle the switch from ON to OFF and vice-versa depending on the initial condition.

(6) Setting termination

ENT: The switch condition is stored in the internal memory of the Rec. Branch to the selection menu (Fig. 14.1) to set other switches, if desired.

MEN: Branch to the main menu - page 2.

(7) Setting options

- Compensator:

Default: ON

Switch toggling only possible in the Rec Elta 2 and 3.

- Compensator OFF

e.g. in the case of strong ground vibrations when reading angles.

The chosen switch setting is the default setting of the softkey 3 in the measurement menus ON → Kon, OFF → Kno.

- Illumination:

Default: OFF.

Turn the illumination on only if the lighting conditions are bad to avoid battery discharging.

- Auto (T,P):

Switch OFF:

The temperature and atmospheric pressure can be entered in the input menu (see 6.) only manually.

Measurements are corrected with the entered values.

Switch ON:

In the input menu the scanned values for temperature and atmospheric pressure (barometric height) are displayed in inverted form.

Measurements are corrected continuously.

When you store the input menu values (see 6.), a note appears in the point information field on automatic sensing resp. manual entry.

- Recording:

Default: ON.

In the measurement modes, the default recording options (R-M = recording of measured values or R-C = recording of computed values) are then set automatically.

- Switch OFF:

Soft key (FCT + 4) is set to the default value Rno in all measurement modes if a Mem is inserted.

- Sound:

Default: ON (for its applications see 1.4.2).

The word "Geodesical" is written in a light blue, sans-serif font. A thin, light blue oval ring is positioned around the letter 'G', partially overlapping it.

 **Geodesical**

15. EDITOR Program

15.1 Survey

(1) Purpose

Input, recall and display, editing and deletion of records.

(2) Editor function selection

The EDITOR program is listed on page 2 of the main menu, i.e. change from page 1 to page 2 of the main menu with key 0.

Select the EDITOR program with numeric key 6; simultaneous change to the selection menu (see Fig. 15.1.1).

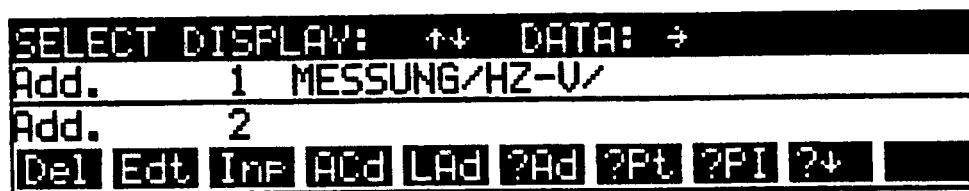

Fig. 15.1.1: Selection menu of EDITOR

(3) Description of the selection options

The soft keys in line 4 afford entering, recalling and displaying, editing and deleting records.

Key	Function	
▲, ↓,	Scrolling in the data and toggling between the display of measured or computed data or the P.I.	
▶, ◀		
FCT + 1	Softkey Del	Deletion of records with different options
FCT + 2	Softkey Edt	Editing of records
FCT + 3	Softkey Inp	Input of coordinate records
FCT + 4	Softkey AcD	Additional codes for a series of records
FCT + 5	Softkey LAd	Display of the last address
FCT + 6	Softkey ?Ad	Memory search for a given address
FCT + 7	Softkey ?Pt	Memory search for a given point number
FCT + 8	Softkey ?PI	Memory search for a given point identification
FCT + 9	Softkey ?↓	Further searching with the same searching mask
MEN:		Branch to the main menu - page 2.

15.2 Record Display

(1) Purpose

- Survey of the recorded data
- Record checking before editing or deletion
- Search for given records

(2) Search for records with cursor keys

The vertical cursor keys \uparrow, \downarrow afford scrolling in the data (Fig. 15.2.1).

The horizontal cursor keys \rightarrow , toggle between display of the P.I. and the associated coordinates or measured data (Fig. 15.2.1 and 15.2.2).

The display window remains on line 2, the soft key line remains visible during all operations, and in the first line the dialog information is replaced by a third record.

Key	Function
\blacktriangle	Scrolls down in the data file. Jumps directly from the first record to the last address.
\blacktriangledown	Scrolls up in the data file. Jumps directly from the last record to the first address.
\blacktriangleright	Shifts the display field right, coordinates or measured values are visible.
\blacktriangleleft	Shifts the display field left, P.I. is visible.

Add.	214	COORDINATES/SIDE	SHOTS/						
Add.	215	1501		PP					
Add.	216	1502		PP					
Del	Edt	Inf	ADD	LAD	PAD	PPT	PPI	P4	

Fig. 15.2 1: Left part of the record - address + point identification

SELECT DISPLAY: $\uparrow\downarrow$ P.I.: \leftarrow									
Y	6533.058	X	7528.737	Z	0.000				
Y	6534.870	X	7528.844	Z	504.094				
Del	Edt	Inf	ADD	LAD	PAD	PPT	PPI	P4	

Fig. 15.2.2: Right part of the record - coordinates or measured values

15.3 Record Retrieval

(1) Purpose

If you know the point number, address or point identification, records can be retrieved in different ways. The search begins at the current address (framed in line 2, see Fig. 15.2.1).

(2) Recall with soft key LAd

Pressing soft key LAd causes the last address to be displayed in line 2 (see Fig. 15.1.1). Vertical cursor keys lead directly to the first (↓) or the second-last address (▲).

(3) Recall with soft key ?Ad

Soft key ?Ad directly retrieves a given address and displays it.

Up to 4 digits can be entered. Address input is similar to the INPUT program.

The found record is displayed and framed in line 2 (see Fig. 15.2.1).

The preceding and following records are also displayed (see Fig. 15.2.1).



MEM-ADDRESS: 293 INPUT ENTER

Fig. 15.3.1: Recall by address

(4) Recall with ?Pt

Soft key ?Pt retrieves a specified point number (see Fig. 15.3.2).

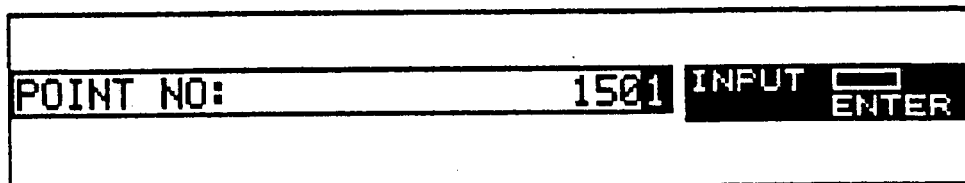

POINT NO: 1501 INPUT ENTER

Fig. 15.3.2 : Recall by point number

The retrieved record is displayed and framed in line 2 (see Fig. 15.2.1).

The preceding and following records are also displayed.

(5) Recall with ?PI

Soft key ?PI can be used to search for a totally or only partially known point identification in a specific mark (see Fig. 15.3.3).

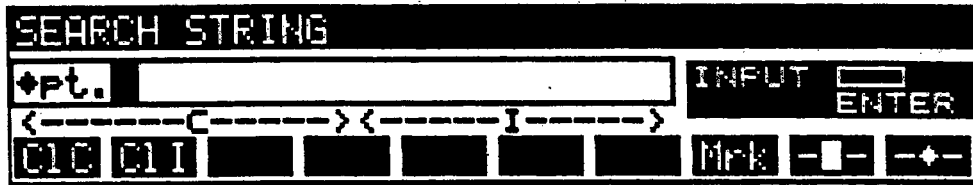

Fig. 15.3.3 : Search by partial point identification

Retrieval is supported by 3 soft keys.

Mrk: Selection of the mark

-.-: Place holder for unknown characters (formatted input). Stands for random information that is suppressed during retrieval.

-+-: Wildcard for an unknown area (unformatted input)

Place holders and wildcards can be used in different combinations.

(6) Recall with ?↓

If there is an address found with the options ?Pt or ?PI the search for another data line can be continued with this searching mask by means of softkey ?↓.

15.4 Additional code

Soft key ACd provides fast access to random records for adding further information or overwriting errored information.

When you call this option, the whole P.I. is filled with place holders (see Fig. 15.3.4).

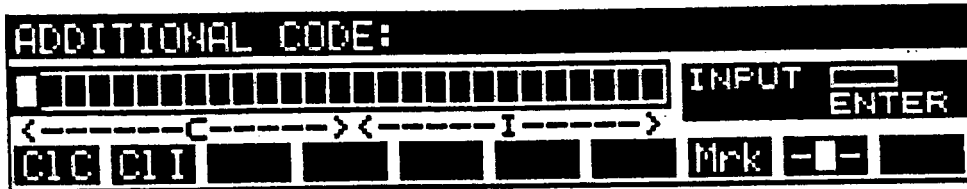

Fig. 15.4.1 : Input of an additional code

After selecting the desired mark with soft key Mrk, you can overwrite the place holder with the required modifications. Inadvertently modified place holders can be restored with soft key --.

ENT calls the selection menu for the records to be edited (see Fig. 15.3.5).

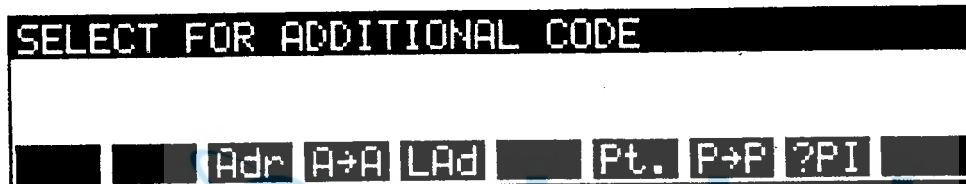

Fig. 15.4.2: Record selection

Selection is supported by 6 soft keys.

- Adr: Editing information at a given address
- A→A: Editing from a given address to another address
- LAd: Editing of the last address
- Pt.: Editing the information on a given point number. If the point number is redundant, the correct point can be located under program control (see Fig. 15.3.6).
- P→P: Editing from a given point number up to a given point number
- ?PI: The records to be edited can be selected by the criteria described in (5) Recall with ?PI.

Is the search done by ?Pt or ?Pl, the program stops at the first line found with the searching mask (fig. 15.).

```

Y      6533.058X      7528.737Z      0.000
ADD.   215   1501           PP
CONTINUE SEARCHING ?           YES NO
                                   └─┘ └─┘

```

Fig.15.4.3: Search continuation

YES: The search is continued.

NO: When searching with P→P the second point number is now entered and searched. In the other cases you are asked whether the additional code is to be transferred (fig.).

```

ADDRESSES
ADD.   215 1501           PP
ADD.   220 1501           PP      / 215
WRITE ADD. CODE ?           YES NO
                                   └─┘ └─┘

```

Fig. 15.4.4: Overwriting

YES: Brief display of the modification and return for selecting further records.

NO: The record is not overwritten (brief display: Nothing Overwritten!). Branch to the menu for selecting further records.

MEN: Return to the DISPLAY SELECT program.

For the meaning of further soft keys see 15.4.

15.5 Coordinate Records Entry

(1) Purpose

Manual entry of coordinate records that are required for computation or measurement but are not contained in the memory.

Coordinate records can be entered with soft key Inp, which should not be confused with the INP key for calling the INPUT program.

(2) Input menu selection

Pressing soft key Inp causes the display to change from the Editor selection menu (Fig. 15.1.1) to the selection menu for coordinates or P.I. input (see Fig. 15.4.1).

Y	0.000X	0.000Z	0.000
			SELECT: ←↑↓→
			ENTER
←-----C----->		←-----I----->	

Fig. 15.5.1: Input selection menu

(3) Input field selection

The vertical and horizontal cursor keys move the input field to the coordinate or P.I. to be entered.

(4) Input activation

ENT: Activates input in the point identification (see Fig. 15.4.2) or coordinate display field (see Fig. 15.4.3) The soft keys in line 4 support input.

(5) P.I. input

Input of numbers, letters or special characters for the P.I. according to the COMMON FEATURES program (8.3) or the input menu of the measurement modes (8.2).

The mark selected last is displayed below the input field (see Fig. 15.4.1). Selecting another mark with soft key Mrk is possible.

Further soft keys support input. Soft key Inf (see Appendix A 2) suspends P.I. input for entering an information line that is stored first. The ABC key causes the soft key line to be overwritten by the alpha assignment.

ENT terminates input. Change to the selection menu (see Fig. 15.4.1).

Y	0.000X	0.000Z	0.000
5510	TP	INPUT	ENTER
<-----C----->		<-----I----->	
CLC	CLI	Inf	Mrk

Fig. 15.5.2: P.I. input menu

(6) Coordinates input

Steps (3) and (4) apply similarly.

Input of numbers according to the INPUT program (8.3) - (see Fig. 15.4.3).

ENT: Terminates input.

Y	0.000X	0.000Z	0.000
5510	TP	SELECT: ++++	ENTER
<-----C----->		<-----I----->	

Fig. 15.5.3: Coordinates input menu

(7) Input termination

MEN: Terminates input in the selection menu (see Fig. 15.4.1). Change to Fig. 15.4.4, which requests a decision on recording the data.

YES: Displays the address of the stored data and changes to the input selection menu for the next record (see Fig. 15.4.1). The entries made in the last record are displayed and need only be edited.

If no further data line is to be entered you can jump back to the EDITOR display (15.4.1) with MEN without recording.

NO: Change to the EDITOR display (see Fig. 15.1.1).

RECORD THIS DATA SET ?	
YES	NO

Fig. 15.5.4: Data recording

15.6 Record Editing

(1) Purpose

Editing of errored point identifications or coordinates.

In all other records, only the P.I. field can be edited. The other input fields are blocked against input.

(2) Selection of the record to be edited

Recall the record to be edited with the cursor keys or with soft keys LAd, ?Ad, ?Pt or ?PI (see 15.3 (2) and (3)). The record to be edited is displayed in line 2 of the display.

Call the editing routine with soft key Edt; change to the display of Fig. 15.4.1.

Edit as described in Coordinate records input (15.4 (2) to (7)).

(3) Particularities

Soft keys lno and lnf are not active for editing the P.I.

ENT: The edited record is stored at the old address.



15.7 Record Deletion

(1) Purpose

Deallocating storage space by deleting the whole memory or by selectively deleting specific measurements or values.

(2) Record selection

Select records for deletion with the following soft keys (Fig. 15.7.1):

All: All records
 Adr: One record
 A→A: From a start address to an end address
 LAd: Last address
 Pt: Point number
 P→P: From a start point to an end point
 ?PI: Point identification



Fig. 15.7.1: Record selection

(3) Soft key ALL

Soft key All changes the display to Fig. 15.7.2, which asks if all data is to be deleted.

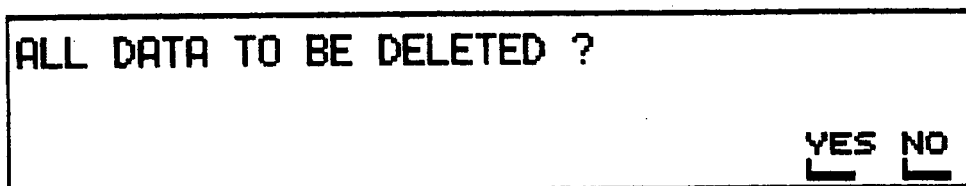

Fig. 15.7.2: Deletion of all data

YES: The question appears again to avoid inadvertent deletion (see Fig. 15.7.3).

NO: Brief display: NOTHING DELETED!
 Change to the record selection menu (see Fig. 15.7.1)

<p>ALL DATA TO BE DELETED ? ARE YOU SURE ?</p> <p style="text-align: right;">YES NO └─┘ └─┘</p>

Fig. 15.7.3: Deletion check

YES: All records are deleted.

NO: Brief display: NOTHING DELETED!

Branch to the record selection menu (see Fig. 15.7.1).

(4) Soft key A→A

Soft key A→A changes the display to Fig. 15.7.4 for the selection of the start and end addresses.

DELETION		
START ADDRESS :	1	SELECT: ↑↑↓↓ ENTER
END ADDRESS :	293	

Fig. 15.7.4: Selection

↑, ↓: Selection of the start and end addresses

ENT: Confirms selection. Branch to the input menu (see Fig. 15.7.5).

MEN: Branch to Deletion (see Fig. 15.7.9).

DELETION		
START ADDRESS :	1	INPUT <input type="text"/> ENTER
END ADDRESS :	293	

Fig. 15.7.5: Address input

MEN: Resets the old value

ENT: Confirms input and branches to the selection menu (see Fig. 15.7.4).

Repeat the procedure for the end address.

MEN: Branch to (6) Deletion (see Fig. 15.7.9).

(5) Soft key P→P

Soft key P→P affords deletion of addresses from a given point number up to another given point number.

If there are redundant point numbers, the correct ones can be selected under program control.

Fig. 15.7.6: Input of the first point number

MEN: Brief display: NOTHING DELETED!

Branch to record selection (see Fig. 15.7.1)

ENT: Start of search and display of the following query:

Y	6533.058X	7528.737Z	0.000
ADD.	215	1501	PP
CONTINUE SEARCHING ?			YES NO

Fig. 15.7.7: Continue

YES: Search is continued

NO: Input of the second point number (see Fig. 15.7.8)

2. POINT NO.:		1504	INPUT	ENTER
---------------	--	------	-------	-------

Fig. 15.7.8: Input of the second point number

MEN: Brief display: NOTHING DELETED!

Branch to record selection (see Fig. 15.7.1)

ENT: Branch to 15.7.7: Continue

When the second point number is found:

NO: Branch to (6) Deletion.

(6) Record deletion

The retrieved P.I. and the associated addresses are displayed automatically.

ADDRESSES			
ADD.	215	1501	PP
ADD.	218	1504	PP
DELETE	?		YES NO
			<input type="checkbox"/> <input type="checkbox"/>

Fig. 15.7.9: Deletion

- YES:** Brief display of the deleted records. Branch to the selection menu (see Fig. 15.7.1).
- NO:** Brief display: NOTHING DELETED!
Branch to the selection menu (see Fig. 15.7.1).

The remaining soft keys are described in 15.3, Record Retrieval with Soft Keys.

Note:

- The address of the remaining lines is saved.
- The deleted lines are shown empty in the display.
- By deleting space capacity is set free if sectors in the Mem are deleted completely. One sector generally contains 3,5 data lines.

 **Geodesical**

16. TRANSFER Program

16.1 Survey

(1) Purpose

The data measured in the field can be transferred to a computer in the office for further processing or they can be sent to a printer for documentation. In general, devices which are connected to the RecElta are called peripheral devices.

Data transfer from the peripheral device to the Rec Elta is required, e.g. for setting-out, to compute the setting-out elements in the field from the coordinates computed by the computer in the office.

Communication between the Rec Elta and the peripheral device is only possible if the data transfer parameters (baudrate, parity etc.) are properly set in this program .

Future software updates in the Rec Elta, DAC E and the Mem are possible with this program.

When you turn the Rec off, the original functions of the Elta can be used without recording.

(2) Transfer mode selection

The TRANSFER program is listed on page 2 of the main menu, i.e. use key 0 to change from page 1 to page 2 of the main menu.

Select the TRANSFER program with numeric key 7; the selection menu appears (Fig. 16.1.1).

```
TRANSFER: SELECT MODE          EXIT: MEN
INTERFACE 1: PRINT. INTERFACE 2: COMP.1
  [ ] UPDATE          [ ] REC E OFF
  [ ] DISK DRIVE     [ ]
  [ ]                [ ]
```

Fig. 16.1.1: Selection menu of TRANSFER

16.2 Interface Selection

(1) Purpose

Two interfaces (interface 1 and 2) can be defined by setting the data transfer parameters and they can be called during the data transfer.

(2) Interface access

The handling of both interfaces is identical. Therefore the description of interface 1 is sufficient.

- Interface 1: Default printer interface for line-controlled transfer
- Interface 2: Default computer interface for software-controlled transfer.

Select the interface with numeric key 1 (interface 1) or numeric key 6 (interface 2) in Fig. 16.1.1; Fig. 16.2.1 appears for specifying the data transfer direction or defining parameters.

```

INTERFACE 1: PRINT.                               EXIT: MEN
REC E --> PERIPHERAL DEVICE
PERIPHERAL DEVICE --> REC E
DISPLAY/EDIT PARAMETERS
  
```

Fig. 16.2.1: Selection of the transfer direction

(3) Selection of the transfer direction

As indicated by Fig. 16.2.1, the bidirectional data transfer capability of the Rec Elta enables data transfer with

- numeric key 1: from the Rec Elta to a peripheral device
- numeric key 2: from the peripheral device to the Rec Elta

Case 1: Data transfer from the Rec Elta to a peripheral device

Connect the peripheral device to the Rec Elta before data transfer.

(4) Data selection

The data to be transferred can be selected with soft keys (Fig. 16.2.2).

All: All records

Adr: One record (enter the address)

A→A: From a start address up to an end address (enter the addresses). Exit from data selection with MEN

LAd: Last address

Pt.: Point number

P→P: From a start point up to an end point

?Pt: Point identification

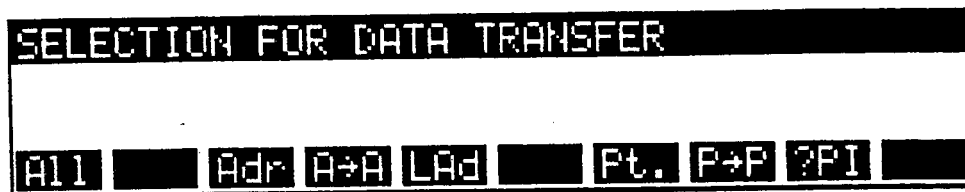

Fig. 16.2.2: Record selection

(5) Data transfer

Data transfer can be started after record selection (see Fig. 16.2.3). Beforehand, the data transfer program has to be started in the computer and initiated so that data can be received from the Rec Elta.

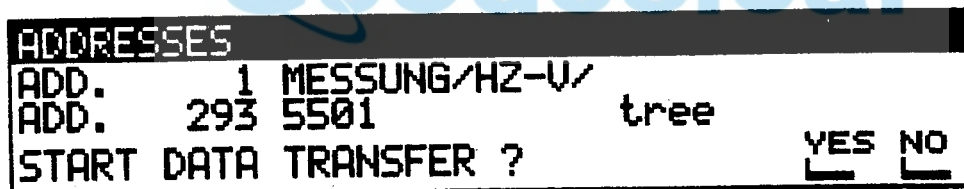

Fig. 16.2.3: Start of data transfer

YES: Starts data transfer; the transferred addresses are displayed continuously.

NO: Returns to the record selection menu (Fig. 16.2.2).

Case 2: Data transfer from a peripheral device to the Rec Elta

Connect the peripheral device to the Rec Elta before data transfer.

(6) Peripheral device connection and data transfer

Peripheral device connection is requested in Fig. 16.2.4 for checking purposes.

Beforehand, the data transfer program has to be started in the computer and initiated so that data can be transferred to the Rec Elta.

PERIPHERAL DEVICE CONNECTED ?
<input type="checkbox"/> YES <input type="checkbox"/> NO

Fig. 16.2.4: Peripheral device connection

YES: The Rec Elta displays "READY TO RECEIVE" to indicate that data transfer can be started.

NO: Exit and change to Fig. 16.2.1.

The logo for Geodesical, featuring the word "Geodesical" in a blue, sans-serif font. A blue orbital ring encircles the letter "G".

16.3 Parameter Setting

(1) Purpose

Individual configuration of the interface by setting parameters for communication with the peripheral devices.

(2) Setting menu selection

Numeric key 3 in Fig. 16.2.2 calls the selection menu for setting the data transfer parameters (see Fig. 16.3.1).

NAME: COMP. 1	FORMAT: REC500	INTERFACE 2
BAUD: 9600	PRCTL: REC500	SELECT: ↑↑↓↓
STOP: 2	PRTY: EVEN	ENTER
T/O: 10	LF: YES	

Fig. 16.3.1: Setting the data transfer parameters

(3) Selection of the parameters to be set

Use the cursor keys ← (left), → (right), ▲ (up) and ▼ (down) to move the input field to the parameter to be changed.

MEN: Change to page 2, if required, to select the connector type (DAC E only) and set additional spaces for data transfer (see (6)).

(4) Input activation

ENT: Confirms correct selection; the editing menu (Fig. 16.3.2) appears.

NAME: COMP. 1	FORMAT: REC500	INTERFACE 2
BAUD: 9600	PRCTL: REC500	CHANGE ↑↓
STOP: 2	PRTY: EVEN	ENTER
T/O: 10	LF: YES	

Fig. 16.3.2: Editing menu

(5) Entry editing

Press the vertical cursor keys ▲, ▼ until the desired parameter appears in the input field.

ENT: The selected parameter is saved and the input field is free for selecting another parameter.

MEN: Return to the calling program part (Fig. 16.2.1).

(6) Editing options

Default parameter settings:

Parameter	Interface 1	Interface 2
1. NAME :	PRINT.	COMP.1
2. BAUD :	4800	9600
3. PRTCL :	LN-CTL	REC500
4. STOP :	2	2
5. PTY :	ODD	EVEN
6. T/O :	10	10
7. LF :	YES	YES

Changes:

Names or values can be selected from a list of the selected parameters.

- NAME : Mode 1 - Mode 2 - Print. - Comp.1 - Comp.2 -
Accoust - Modem - Cass.- Buffer
- BAUDRATE : 300 - 600 - 1200 - 1800 - 2400 - 4800 - 9600
- STOP : 1 or 2 bits
- T/O (Timeout) : 0 - 10 - 20 - ... - 90 sec.
- FORMAT : Rec 500 or Rec 200
- PRTCL (Protocol) : Rec 500, Rec 500 + LN, LN-CTL, LN-CTL + E,
XON/OFF, XON/XOFF + E
- PTY (Parity) : Odd - even - no
- LF (Line Feed) : Yes - No
- ADD SPACES : Additional spaces (0 to 99) to create larger
records
- CONN : 8-point or 25-point connector (only Dac E)

Note:

Detailed information on data transfer is given in chapter 19.,
INTERFACE DESCRIPTION.

16.4 Update

This menu allows updating the software in the Rec E, Dac E or the Mem.

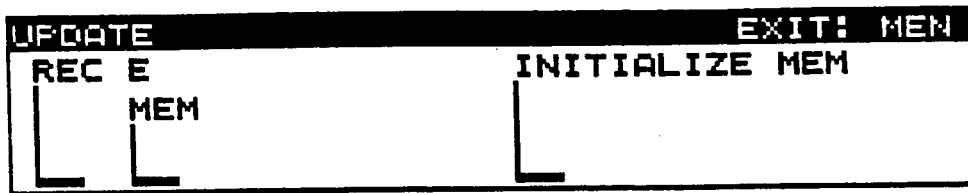

Fig. 16.4.1: Selection menu of Update

The update program has to be started in the computer and initiated so that the update can be started at the Rec E.

Mem initialization

You are told by an error message 4WR if there is no further recording in the Mem possible. The Mem has to be reinitialized in this case. Beforehand, the data stored in the Mem should be transferred to another storage medium because initialization causes the data to be lost.

Geodesical

16.5 REC E Off

The programs in the Elta can also be used if you turn the Rec E off. Refer to the Elta manual which can be ordered from Carl Zeiss. The Rec 500, for example, could be connected instead.

```
REC E OFF: SWITCH ON ELTA PROGRAM ?  
  
YES NO  
  _  _
```

Fig. 16.5.1: Rec E piping?

NO: Branch to the TRANSFER menu
YES:

```
ELTA PROGRAM SWITCHED ON !  
EXIT: MEN
```

Fig. 16.5.2: Rec E off

The Elta is now controlled with its 3 keys.

MEN: - Back to the Rec Elta program
- Brief display of the input logo;
branch to the main menu.
The Rec E is operable again.

16.6 GT-DOS DISK DRIVE

(1) Purpose

The GT-DOS disk drive allows data to be stored on 3,5" diskettes independently of a mains supply. This allows, for example, to Mem contents to be deleted in the field to allow further measurements. The data on the diskette can then be operated on in the office independently of the Mem.

Alternatively, coordinate data for the entire measurement area may be pre-stored on diskette and transferred into the Mem as required.

(2) Requirements

The disk drive must be set to 19200 baud in order to work with the Rec Elta (or Dac) - see page 15 of the Oracle GT operator's manual. If the drive is also to be used with a Rec 500, it is necessary to switch the baud rate, because the Rec 500 requires the GT to operate at 38400 baud.

The Rec Elta software, version 2.00, has the GT-DOS Data Transfer option as standard.

The disk drive is supplied with the cable 7081 77-9290 for connection to the Rec Elta.

(3) GT Format

Data sets are stored on the diskette in a special GT format, which are automatically given the extension '.GT'.

Implications for Rec Elta:

- Files with an extension other than .GT can only be loaded into the Rec Elta when their contents conform to the GT format.
- The Rec Elta cannot append data to a file with an extension other than .GT.

Implications for PC:

- Disk files with the extension .GT must be converted into ASCII files in the Rec 500 format. These normally have the extension '.DAT'.
- The Rec 500 format ASCII .DAT files must also be converted into GT-format .GT files before they can be loaded into the Rec Elta from the disk drive.
- For this purpose, a program called GTCOPY is supplied with the GT-DOS drive, which has the same operating conventions as the DOS command COPY.
- GTCOPY can work in both directions:
GTCOPY *.GT C:*.DAT (* is the wildcard for file names)
GTCOPY C: *.DAT *.GT

(4) Capacity and speed

The disk drive can be used with DD and HD disks. This allows the following capacities:

DD (720 KB) = 5696 data lines
 HD (1.44 MB) = 11376 data lines

Unformatted disks can be formatted with the GT-DOS drive.

The disk drive manages diskettes in blocks of 2KBytes. Each block can hold up to 16 data lines.

Speed of operation is dependent on the direction of transfer:

Diskette to Mem D → M : 158 lines / minute
 Mem to Diskette M → D : 231 lines / minute

(5) Programm selection

The DISKETTE mode is selected using the number key 3 in the DATA TRANSFER program (fig. 16.6.1). The Rec E will display a message describing how the disk drive is to be set up.

```

Transfer: Disk          Start: ENTER
1. Connect disk drive
2. Switch on disk drive
3. Insert a disk
  
```

Fig. 16.6.1: Disk drive preparation

ENT: Start the mode. The following message will be briefly displayed.

READING DIRECTORY:

This is followed by the directory menu.

No.	FILENAME EXT	RECORDS	FREE :	4448							
1	RCR01.GT	100	SELECT:	↑							
<table border="1"> <tr> <td>D→M</td> <td>M→D</td> <td>Del</td> <td>Nam</td> <td>Frm</td> <td>Dir</td> <td>?No</td> </tr> </table>					D→M	M→D	Del	Nam	Frm	Dir	?No
D→M	M→D	Del	Nam	Frm	Dir	?No					

Fig. 16.6.2: Directory menu

where:

NR. : Sequence number
 FILENAME : Name of the file
 EXT : Name of the extension used
 LINES : Number of data lines on the disk
 FREE : Number of free data lines on the disk

The entire (root) directory of the disk may be inspected using the cursor keys \uparrow and \downarrow .

(6) Soft keys

Data transfer can be started, or the diskette can be prepared, using the available soft keys.

D \rightarrow DM : Data transfer from diskette to Mem

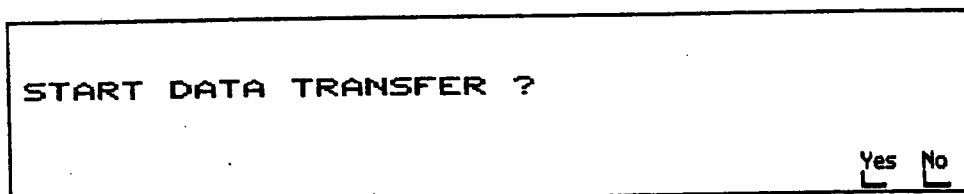

Fig. 16.6.3: Diskette - Mem

NO: Return to directory menu
 YES: The selected file is loaded into the Mem.

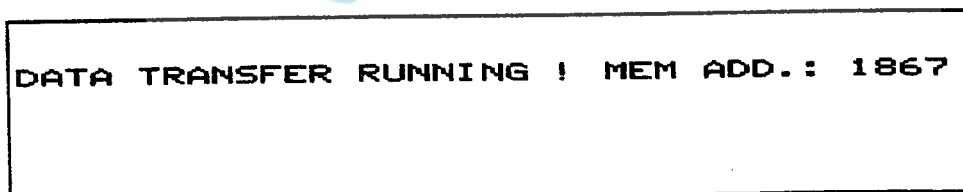

Fig. 16.6.4: Data Transfer

The Mem address will be continually counted. At the end of the data transfer, there will be 3 short beeps. The directory menu (fig. 16.6.2) will be displayed.

Important:

The data transfer can be aborted with MEN. The last data line will be correctly transferred. Even if the Rec Elta battery fails, or if the cable connection is broken, the last data line transferred will still be correct.

M → D : Data transfer from Mem to Diskette

Fig. 16.6.5: File name entry

The DOS conventions apply when a file name is being entered. Not all special characters are available in the ABC-entry. The '.' and '-' keys on the Rec keyboard are also blocked. '.GT' will be automatically added to the file name.

ENT: Confirm the entry.

Fig. 16.6.6: Select the files

Files can be selected as previously described in 15. EDITOR or in 16.2 (4) Data Selection.

Fig. 16.6.7: Data Transfer

The data lines are continuously counted. At the end of the data transfer, there will be 3 short beeps. The directory menu (fig. 16.6.2) will be displayed.

Important:

If, during the data transfer, the Elta battery fails or the cable connection is broken, the Rec E will display the error 685 (Time out). In this case disk drive can not be used directly; the reset key on its underside must be pressed using a paper clip or similar implement. The current file cannot be closed, and is NOT correctly transferred. It may not be displayed in the directory menu.

MEN: Return to directory menu.

```

FILE: RCR001 .GT DELETE ?
                                     YES NO
                                     L  L
  
```

Fig. 16.6.8: Delete

YES: The displayed file will be deleted.
 NO: Return to Directory Menu.

Nam: Rename a file

```

RENAME FILE
FILE-NAME: RCR001 .GT INPUT
                                     ENTER
  
```

Fig. 16.6.9: Rename

Frm: Format a diskette

```

FORMAT DISK EXIT: MEN
720 K-BYTE
1.4 M-BYTE
  
```

Fig. 16.6.10: Diskette selection

It is possible to select between DD diskettes (720 KB) with key 1 and HD (1.44 MB) diskettes with key 2.

```

ALL DATA WILL BE DELETED !!!
ARE YOU SURE ?
                                     YES NO
                                     L  L
  
```

Fig. 16.6.11: Check

Since any data on the disk will be lost when the disk is formatted, the procedure must be confirmed again.

YES: The disk will be formatted. This takes about 1 minute.
 NO: Return to directory menu.

Dir: Reads the directory menu from the diskette. This allows diskettes to be changed. The following message will be briefly displayed:

READING DIRECTORY!

?Nr: If there are many files on the diskette, this softkey can be used to select and display any file directly using its sequence number.

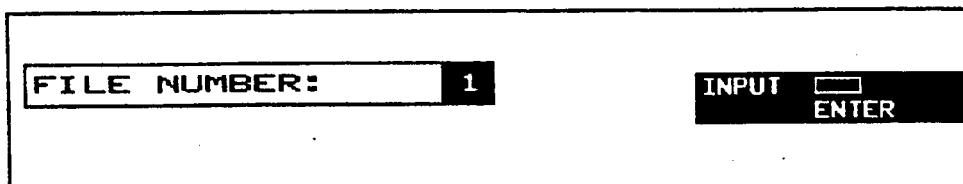

Fig. 16.6.12: File Number

ENT: Confirm the entry, and return to the directory menu. The selected file will be displayed.

MEN: Return to the directory menu. The previously displayed file will be displayed again.

The logo for 'Geodesical' features the word in a light blue, sans-serif font. A stylized blue orbital ring or path curves around the letter 'G'.

The logo for "Geodesical" features the word in a bold, blue, sans-serif font. A light blue, three-dimensional ring or orbit surrounds the letter "G", giving it a technical or scientific appearance.

 **Geodesical**

17 Dac E

17.1 Description

The Dac E (Fig. 17.1) serves as a data converter between the Mem E and peripheral devices such as

- printers,
- cassette recorders,
- buffers,
- floppy disk units,
- computers.

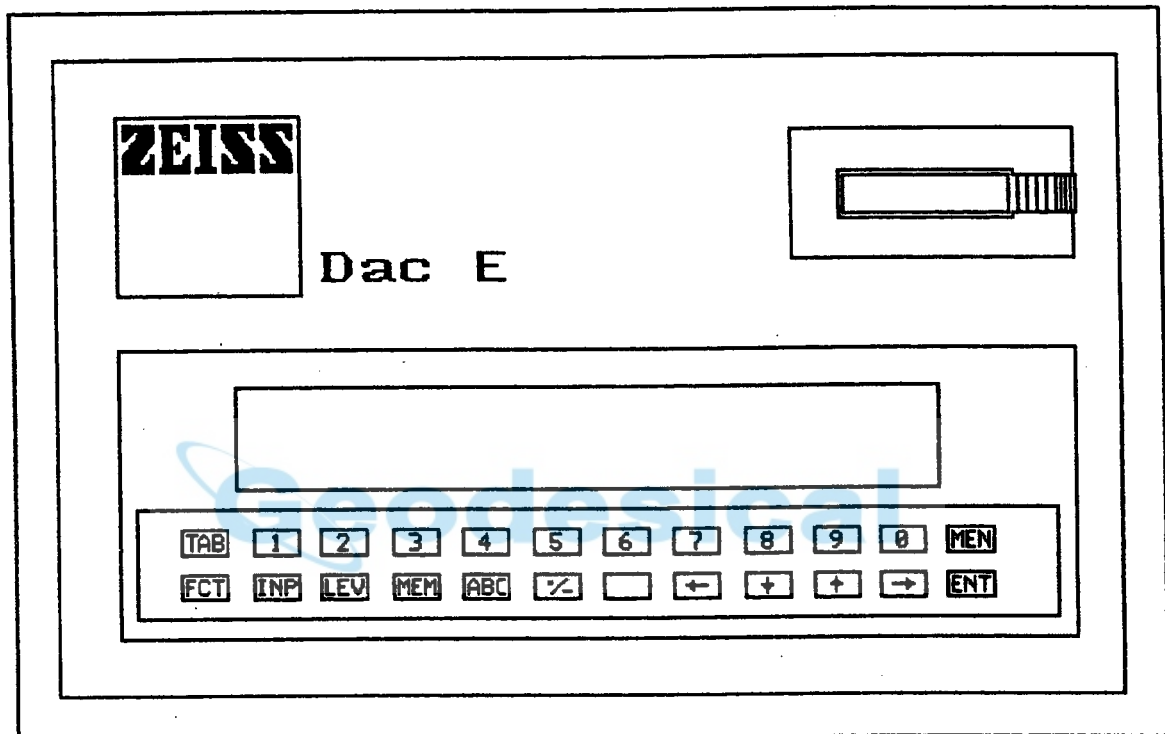

Fig. 17.1 Dac E: Front view

Data transfer is bidirectional so that

- backsight and setting-out points can be transferred from the computer to the Mem E,
- measured values can be transferred from the Mem E to peripheral units

The display, the keyboard and the Mem slot are identical with the Rec E. They are integrated in a separate housing. The user interface of the programs corresponds to the Rec E. The programs are tailored to the Dac E tasks.

The Dac E hardware and software provides 2 RS 232 C/V.24 interfaces.

17.2 Start-up

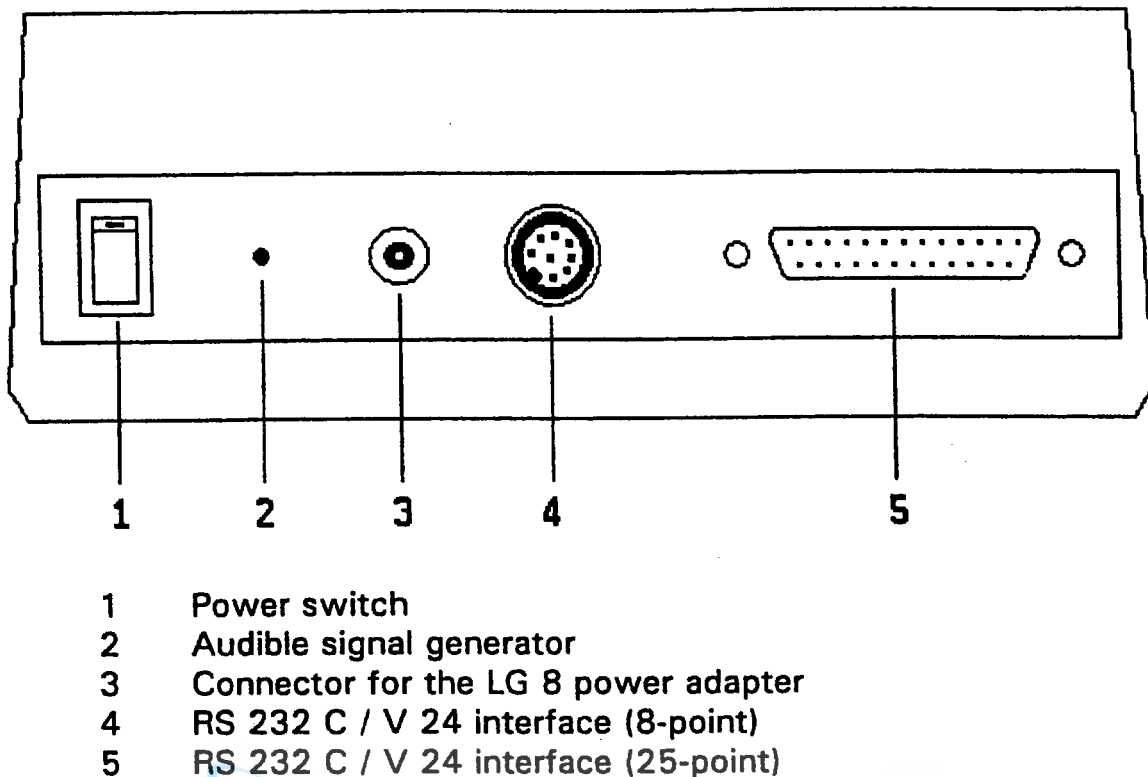

Fig. 17.2 Dac E: Rear view

17.2.1 Power connection

Power is supplied by the LG 8 power adapter supplied with the unit. Before connecting it to the mains, make sure that the correct voltage is set at the LG 8. The preset power voltage (220 V) is visible in the display field of the LG 8. It can be set to 110 V by turning the red slotted screw clockwise.

Plug the power cable in connector 3 (Fig. 17.2) of the Dac E.

17.2.2 Connection of peripheral devices

Connect peripheral devices with fitting cables to interface 4 or 5 (Fig. 17.2). A description of the interfaces is given in section 19.3.

17.2.3 Turning on and off

The Dac E can be turned on and off with toggle switch 1 (Fig. 17.2):

OFF: Toggle switch up

ON: Toggle switch down (red field at switch surface visible)

After turning on, the start-up logo with the current program version number and then the main menu appear in the display (17.3).

The logo for Geodesical, featuring the word "Geodesical" in a blue, sans-serif font. A blue, stylized orbital ring or path surrounds the letter "G".

17.3 Main Menu

The main menu of the Dac E (Fig.17.3) lists the programs that are required for data transfer and for making settings in the Dac E.



Fig. 17.3 Main menu of the Dac E

Use numeric keys 1 to 3 and 6 to 8 to select the individual programs.

17.4 Differences from the Rec E

Operator control and program execution in the Dac E are identical with the Rec E (see the corresponding chapter in this operating manual). There are only a few particularities that are listed in the following.

17.4.1 Keyboard

The INP and LEV keys are ineffective in the Dac E.

17.4.2 Data transfer

The choice of modes in the TRANSFER program (Fig. 17.4) is restricted to 3 options.

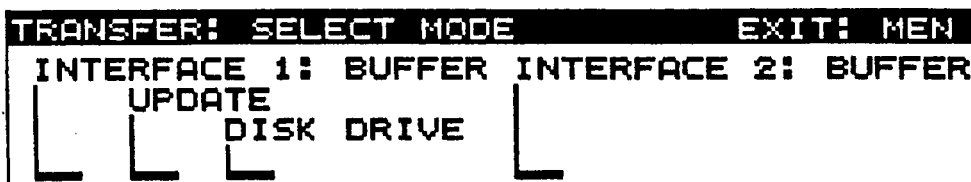

Fig. 17.4 TRANSFER menu

The Rec E menu for displaying and editing the interface parameters (see also Fig. 16.3.1) in the Dac E is supplemented on page 2 by the CONN option (Fig. 17.5). This allows selecting the (8-point or 25-point) connector to be used with the current software interface (1 or 2).



Fig. 17.5 Parameter display/editing (page 2)

17.4.3 Display

The "Set display" mode (bright, normal, dark) of the Rec E ADJUST program is used.

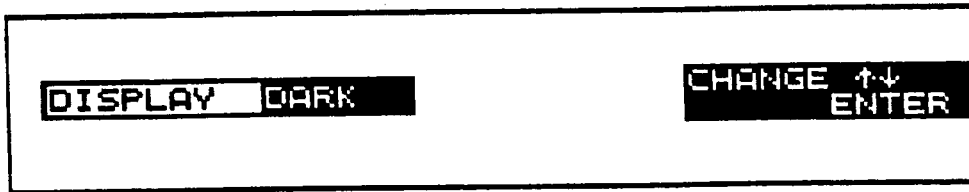

Fig. 17.6 Display setting

17.4.4 Audible signal

The "Audible signal on/off" mode of the Rec E SWITCHES menu is used here.

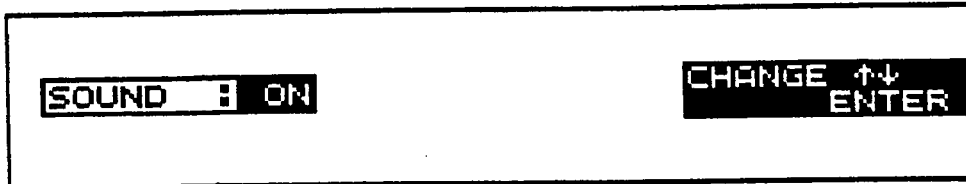

Fig. 17.7 Audible signal on/off

Geodesical

The word "Geodesical" is written in a light blue, sans-serif font. A light blue, three-dimensional ring or sphere is positioned behind the letter 'G', partially overlapping it.

18 Mem E Memory

18.1 Features

The Mem E is an interchangeable memory that combines large-scale miniaturization with a large memory capacity. Non-volatile memory chips allow dispensing with a buffer battery and ensure a data retention time of at least one year.

The memory area (160 KB) has 640 sectors with 256 bytes each. Of these, some are used for memory management, e.g. the sector allocation table, the table of contents, index lists for the records, the list of marks etc.

An additional program memory and a microprocessor give the Mem the intelligence required to internally perform all memory operations - reading, writing, searching, deletion etc..

18.2 The Application-Oriented Memory Concept

All incoming records are stored in the Mem E in the Mem format which allows for more information than the Rec 500 format (see 19.5.1):

- Address
- Number of the assigned mark
- 27-digit alphanumeric point identification
- Measuring unit for distances and coordinates
- Measuring unit for angles
- Vertical reference system for vertical angles
- Type code for text records (e.g. project data, mode titles)
- Type code for the values
- Up to 3 values

The records are compressed in the Mem E to the essential content so that - depending on the program and the measurement mode - different record lengths are obtained. This is why the total number of records cannot be specified precisely. The approximate capacity is about 2000 records. The free memory capacity is indicated in percent.

The data is recorded in the Mem in the sequence in which it arrives. This method offers optimum information on the measurement and computation procedures. The following data can be documented:

- | | | |
|----|-------------------------------------|------------------|
| a) | Project data | |
| b) | Mode titles | |
| c) | Set or changed units | |
| d) | Input data | |
| e) | Index correction | — with date |
| f) | Collimation correction | — and time of |
| g) | Compensator center-point | — determination |
| h) | Original measured values | — |
| i) | Reduced measured values | — with point |
| j) | Coordinates | — identification |
| k) | Residuals and other computed values | — |

The measurement procedure can be structured by (a) the optional storage of project data and (b) the automatic storage of titles when you call a new mode.

The initial condition (c to g) can optionally be stored before measurement begins. In this case the current units, input values and instrument errors are grouped in a block. If you make changes during measurement (units, input values) or redetermine instrument errors, this is stored in separate memory records. The new data then applies to all further measurements until you change it again.

The advantages of this concept are obvious:

- The measurement and computation operations are documented completely.
- The structure matches the individual measurement tasks.
- The whole measurement can be analyzed by means of the listing.
- The alphanumeric type codes ensure that the records can be read directly.

Code conversion is not required for interpretation.

The logo for 'Geodesical' features the word in a bold, blue, sans-serif font. A light blue, three-dimensional ring or sphere is positioned behind the letter 'G', partially overlapping it.

 **Geodesical**

19 Interface Description

19.1 What is an Interface

An interface is the point of contact between 2 systems or system areas, i.e. the point at which information is interchanged. To ensure it is understood in the same way by the sending and the receiving system, specific rules must be defined for the transfer of signals and data. Since different conditions generally exist in communicating systems, it is particularly important during interface definition that these differences be compensated.

Basically 3 types of interfaces can be distinguished: hardware, software and user interfaces.

19.1.1 Hardware interfaces

Hardware interfaces physically interconnect functional units such as measuring devices, computers or printers. Important for the user are, for example:

- Shape and pin assignment of the connectors at the functional units and the connecting cables. Section 19.3 deals with this.
- The data transfer method. The parameters and protocols for controlling data transfer are described in section 19.4.

19.1.2 Software interfaces

Software interfaces establish links between programs or program parts.

The data to be transferred must have a defined structure: the record format. The Carl Zeiss record formats are described in section 19.5.

If the two programs use different internal record formats, format conversion is required on one side. This problem is dealt with in section 19.6.

19.1.3 User interfaces

Another interface that is particularly important for controlling a system is the user interface. Interfaces between the user and the system are the display, the keyboard and the software options for user guidance. The Rec Elta concept places particular importance on the design of the user interface. A general introduction is given in chapter 2.

19.2 The Hardware Interfaces in the Rec Elta

The Rec Elta consists of the functional units Elta, Rec E and Mem E. Taking into account a peripheral unit (e.g. a computer or a printer), the following interfaces exist:

- Rec E <-> Elta
- Rec E <-> Mem E
- Rec E <-> periphery

The Rec E thus has a particular function. It is the central control unit between the hardware components on the one hand and the user interface on the other.

19.2.1 Rec E <-> Elta

The Rec E and the Elta communicate via the RS 232 C interface of the Elta, whose pin assignment is identical to that of the Rec E interface described in section 19.3.1.

The Elta performs the function of a measurement sensor. In response to a given command, it senses measured values, corrects them (for the atmospheric conditions, the instrument errors etc.), displays them on the Elta display, and transfers them to the Rec E for further processing. Data transfer synchronization and Elta control is ensured by control words. These internal operations are not visible to the user.

19.2.2 Rec E <-> Mem E

The dialog between the Rec E and the Mem E is similar. Some internal functions such as data management, reading, writing, searching etc. are performed in the Mem and can be initiated by the Rec by means of control words.

19.2.3 Rec E <-> periphery

The interface to the periphery (17 in Fig. 1.2.1) is an asynchronous serial interface that corresponds to DIN 66020 (V.24 / RS 232 C). The pin assignment is given in section 19.3.1.

This interface has 3 functions in the Rec Elta concept:

(1) Data transfer

Direct data transfer via the Rec E/Dac E between the Mem E and the connected peripheral unit (computer, printer,...).

A series of data transfer parameters and protocols are available for controlling this operation (see sections 16.3 and 19.4).

Two interfaces can be selected by software in the Rec for different peripheral devices, i.e. parameters and protocols can be defined in different ways for any device (see section 16.2).

(2) Software updates

Software for the Rec E (Dac E) and the Mem E can be loaded via the interface (see section 16.5).

(3) Elta interface

When the "REC E Off" mode is active in the TRANSFER program, the Rec E interface assumes the functions of the Elta interface. The Rec E then only functions as a cable. This has the following effects:

- Only the Elta is active. The operator can control the system with the 3-key keyboard.
- The Elta uses its own programs and its own user interface.
- Records in the Elta format can be received from a connected peripheral device (e.g. a field computer).
- The Elta can be controlled by a connected computer.

For using this mode, refer to the Elta operating manual.

You can switch to the Rec Elta program again by the MEN key at the Rec.

19.3 Connectors

19.3.1 8-point connector at the Rec E/Dac E

The connector is an 8-point stereo connector (female) as per DIN 41524.

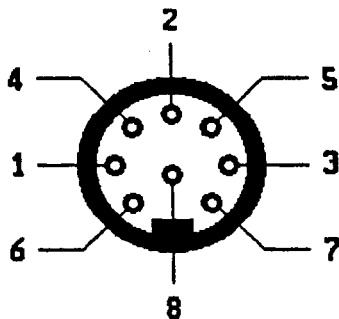

Fig. 19.3.1 Pin assignment (seen from the outside)

Pin	Signal	ON/OFF	Designation	Meaning
1	RTS	OFF	Request To Send	RTS = 1 Rec E/Dac E ready to receive RTS = 0 Rec E/Dac E not ready to receive
2	GND		Signal ground	
3	CTS	ON	Clear To Send	CTS = 1 peripheral device ready to receive CTS = 0 peripheral device not ready to receive
4	TD	OFF	Transmitted Data	
5	RD	ON	Received Data	
6			U _{Batt.}	Voltage
7			U _{Batt.}	Voltage
8	GND		Signal ground	

19.3.2 25-point interface connector at the Dac E

The interface connector is a D-shaped DB-25 connector (male) according to ISO.

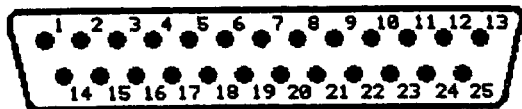

Fig. 19.3.2 Pin assignment (seen from the outside)

Pin	Signal	ON/OFF	Meaning	
1	PG		Protective Ground	
2	TD	OFF	Transmitted Data	
3	RD	ON	Received Data	
	GND		Signal ground	
20	DTR	OFF	Data Terminal Ready	Ready to work DTR=1 Dac E switched on DTR=0 Dac E switched off

19.3.3 Cables

The following table lists the catalog numbers for some standard cables.

Peripheral device	Rec E/Dac E 8-point	Dac E 25-point
DOS-PC, 9-point	708177 - 9260	708177 - 9220
DOS-PC, 25-point	708177 - 9270	708177 - 9210
EPSON printer	708177 - 9300	
Adapter cables		
Rec 500, 25-point *)	708177 - 9290	

*)The adapter cable connects the Rec E/Dac E (8-point round connector) with all existing Rec 500 cables (25-point DB connector) used for data transfer to computers under software control (see 19.4.3.1). This cable enables

- users that already have connected a Rec 500 to a computer to connect a Rec E/Dac E to the existing Rec 500 cable and thus to the computer,
- all existing software-controlled Rec 500 connections to computers to be used also with the Rec E/Dac E.

19.4 Transfer Parameters and Protocols

The data transfer program of the Rec Elta/Dac E offers two different default output and input options that afford data and information interchange over the interface with non-intelligent peripheral devices, e.g. printers and cassette devices, and with intelligent devices, e.g. computers.

The Rec Elta/Dac E provides a series of options for data transfer synchronization. The interface settings recommend, for example, communication with printers via control lines and with computers by a software dialog. However, the XON/XOFF dialog can also be recommended for printers or computers.

19.4.1 Optional transfer parameters

(1) Name	MODE 1, MODE 2, PRINT., COMP.1, COMP.2, MODEM, CASS., ACCOUST, BUFFER	
(2) Baud rate	300, 600, 1200, 2400, 4800, 9600	
(3) Stop bits	1, 2	
(4) Timeout	00, 10, 20, 30, ... , 90 seconds	
(5) Formats	Rec 500, Rec 200	
(6) Protocols	Rec 500	Software dialog
	R500 + LN	Rec 500 dialog + line control
	LN-CTL	Line control
	LN-CTL + E	Line control + end byte *)
	XON/OFF	XON/XOFF protocol
	XON/OFF + E	XON/XOFF + end byte *)
(7) Parity	Odd , even, no	
(8) Line feed	YES, NO	CR LF or only CR as data line or control word termination
(9) Connector	8-point, 25-point **)	Selection option only for the Dac E The two software interfaces can be assigned to the two hardware interfaces.
(9) Additional spaces		This option serves to match the selected record format to special peripheral devices. ***)

*) End byte Some computers require a special end byte to terminate data transfer. By default the Rec E/Dac E uses the end byte EOT = ASCII dec.4. It is transmitted as an additional EOT end character.

- **) 25-point connector Since this connector does not have control lines, the corresponding protocols cannot be used with this connector.
- ***) Additional spaces If a cassette device, for example, can only handle data strings with a length of 86 characters, the selected format can be expanded by additional spaces.

Example:	Rec 500 record	Add. spaces	Delimiter CR, LF	
Characters	78	6	2	= 86

19.4.2 Default parameters

Parameter	Interface 1	Interface 2
Name	PRINT.	COMP.1
BAUD	4800	9600
FORMAT	REC500	REC500
PRTCL	LN-CTL	REC500
STOP	2	2
PRTY	ODD	EVEN
T/O	10	10
LF	YES	YES

19.4.3 Protocol timing diagrams

The following diagrams apply to both directions
(Exception: Rec 500 with line control for the connection to a modem).

- Rec E/Dac E -> Periphery
- Periphery -> Rec E/Dac E

Aborting data transfer on the Rec E/Dac E side is possible at any time by pressing the MEN key. Data transfer is then terminated in accordance with the protocol.

If the Mem becomes full during data transfer to the Rec E/Dac E, data transfer is aborted in the same way.

19.4.3.1 Rec 500 software dialog

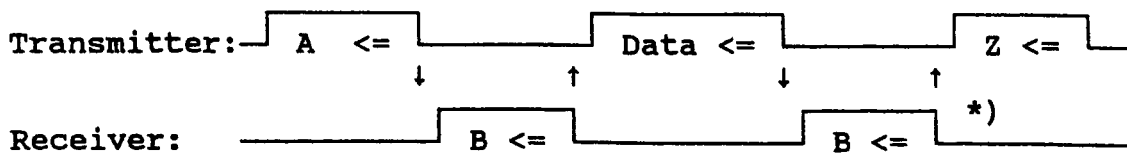

*) If the receiving device sends "Z CR LF" instead of "B CR LF", data transfer is also aborted, for example when an error occurs.

 Geodesical

19.4.3.2 REC 500 + line control (modem lines)

Caution: This protocol should be selected only for computers connected via a modem!

It is only installed at the 8-pin connector because the 25-pin connector hasn't got any control lines apart from DTR.

Control diagram for data output

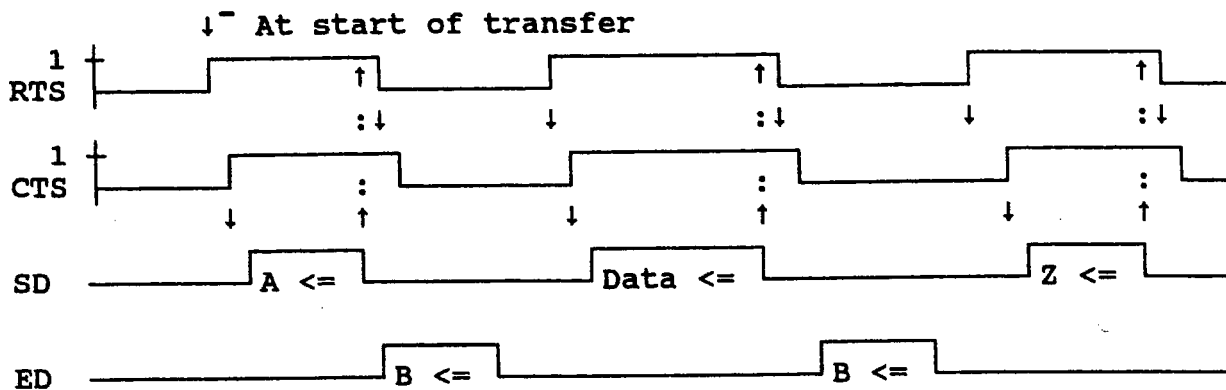

- The dialog corresponds to the Rec 500 software dialog (19.4.3.1)
- In addition, lines for a modem are active.
- Once the data to be transferred has been selected and transfer started, **RTS** is set to Log '1'.
- If the modem returns **CTS** (after a delay of approx. 80 msec.), "A CR LF" can be transmitted because at this time the line to the computer is through-connected at the other modem side.
- **RTS** is reset after the transfer of this first control word (also for data).
- The modem now removes **CTS**.
- After a short delay, bytes are received from the modem (control word "B CR LF" or data) because the other modem can now set **RTS - CTS**.

Control diagram for transfer to the Rec Elta/ DAC E

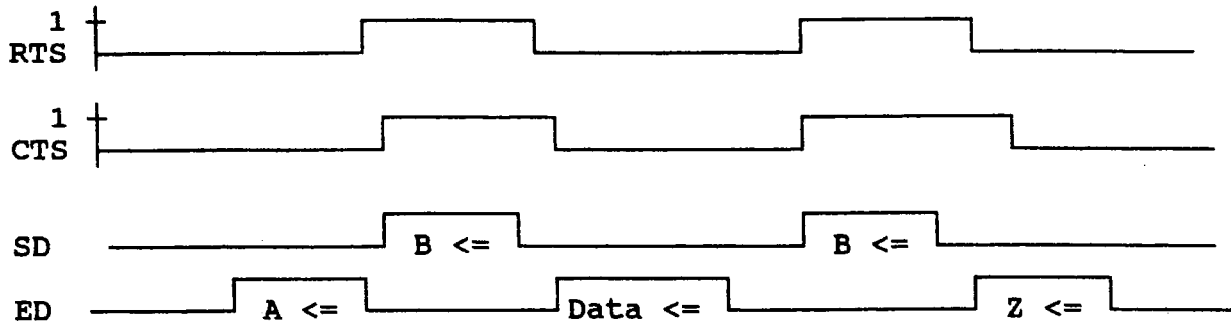

- At this transfer direction the Rec Elta/ DAC E first waits for a A CRLF of the modem.
- Rec Elta/ DAC E now sets RTS to Log '1' (request to send).

19.4.3.3 LN-CTL (line control)

This common line handshake is suited above all to printers, cassette devices or the like (SD from the Rec E/Dac E), but also to computers (SD from the Rec E/Dac E or from the computer).

Caution: This protocol is only available at the 8-pin connector.

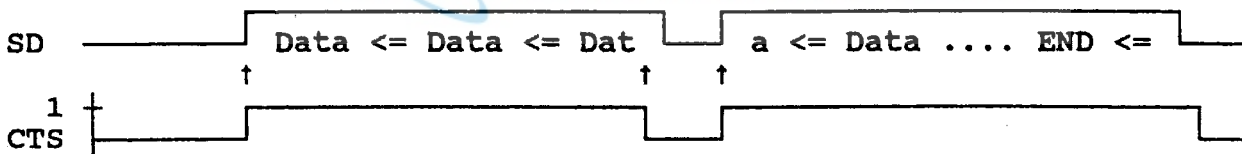

- In this mode, the sender sends records as long as CTS is Log '1'.
- CTS changes to Log '0' if the peripheral device cannot receive the data fast enough (buffer overflow).
- The byte in progress is transferred completely.
- When CTS becomes Log '1' again, transfer is continued.
- The timeout set in the Set menu is used.
- When receiving data the Rec Elta/ DAC E shows RTS = Log '1' when ready to receive.

19.4.3.4 LN-CTL + end byte

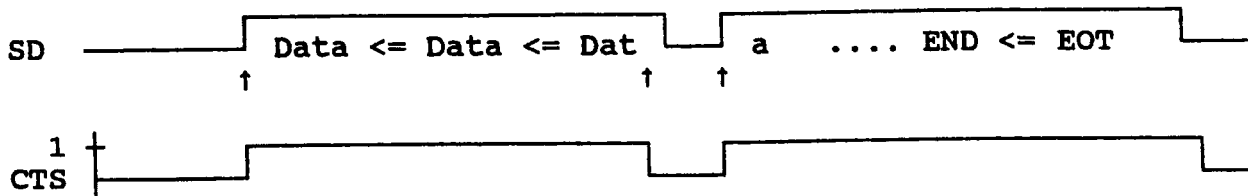

- This protocol corresponds to that described beforehand but an EOT (ASCII 04) is sent additionally.

19.4.3.5 XON/XOFF

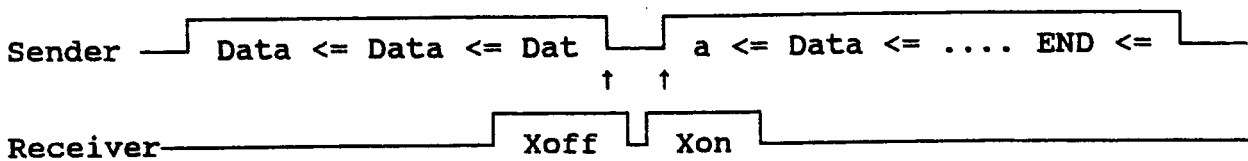

- When XOFF is received, the character in progress is transmitted completely.
- Then a delay occurs until XON arrives from the receiver.
- Data transfer is then continued.

19.4.3.6 Xon/Xoff + end byte

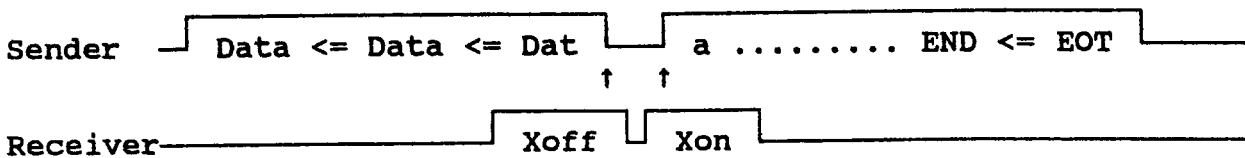

- This protocol corresponds to that described beforehand but an EOT (ASCII 04) is sent additionally.

19.5 Record Formats

For data transfer between the Mem E and peripheral units there are two default record formats, the Rec 500 format (19.5.1) and the Rec 200 format (19.5.2) (see also section 10.3).

During data transfer, the records are converted from the internal Mem format to the selected format (see 19.6).

19.5.1 The Rec 500 record format

19.5.1.1 Format

Position

0	1	2	3	4	5	6	7	8
---	---	---	---	---	---	---	---	---

1234567890123456789012345678901234567890123456789012345678901234567890

Fields

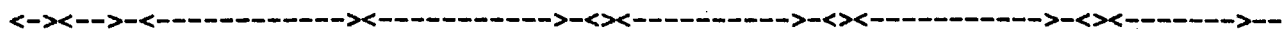

Example

1122 12345678901234ASDFGHJKLZXCV D 2500.941 Hz 256.5224 V1 102.1234

Space

LLL	L				L	L		L	<=
-----	---	--	--	--	---	---	--	---	----

Meaning

ADR	Code C	Additional info. I	T1	Distance	T2	Hor.direct.	T3	
-----	--------	--------------------	----	----------	----	-------------	----	--

Zen.angle

Number of digits

3	4	1	27	1	2	12	1	2	13	1	2	9	11
---	---	---	----	---	---	----	---	---	----	---	---	---	----



Abbr.	Designation	Chars.	Num/Alpha	Meaning
L	Space	1		
ADR	Address	4	Num	Consecutive number of the record (address)
P	Point identification	27	Num/alpha	Point code C and additional information I
T1	Type code 1st value	2	Num/alpha	e.g. D = slope distance, E = horizontal distance, Y = coordinate
W1	1st value	12	Num	
T2	Type code 2nd value	2	Num/alpha	e.g. Hz = horizontal direction, X = coordinate
W2	2nd value	13	Num	
T3	Type code 3rd value	2	Num/alpha	e.g. V1 = zenith angle, Z = coordinate
W3	3rd value	9	Num	
<	CR	1		Control character: CARRIAGE RETURN
=	LF	1		Control character: LINE FEED

19.5.1.2 List of all records

The following table lists the existing records ordered by programs, modes and functions. To accommodate the additional functions of the Rec Elta, the number of fields has been increased compared to the Rec 500.

In the point identification field (P.I.), texts (e.g. mode titles) are created in different places by the program. These are given explicitly in the P.I. column. Point identifications that can be entered by the user are indicated by (.....).

Program/Mode/Function P.I.	Type Codes			Remark
	T1	T2	T3	

PROJECT DATA

..... - - - i = 1...7

INITIAL INSTRUMENT CONDITION

METERS/GRADS/ZENITH/YXZ/	-	-	-
HPA/MB/°C/	-	-	-
INPUT VALUES	m	th	ih
INPUT VALUES (T/P MANUALLY)	C	P	A
INDEX CORR.04.11.1991/10:15	-	-	i
COLL. CORR.04.11.1991/10:20	-	C	-
COMP.C-PNT.04.11.1991/08:23	-	SQ	SZ

INPUT Program

INPUT VALUES	m	th	ih
INPUT VALUES (T/P MANUALLY)	C	P	A
INPPUT VALUES (T/P AUTOM.)	C	P	A

UNITS Program

METERS/GRADS/ZENITH/YXZ/	-	-	-
HPA/MB/°C/	-	-	-

EDITOR (Input)

.....	Y	X	Z	-	Depending
on the					
.....	X	Y	Z	-	selection
in the					
.....	E	N	Z	-	UNITS
.....	N	E	Z	-	program

**ENTRY OF AN
INFORMATION RECORD**

..... - - -

Program/Mode/Function P.I.	Type T1	Codes T2	T3	Remark
ADJUST				
ADJUST/V INDEX/ 04.11.1991/10:15	- Vi	- Vi	- i	Vi = V1-V4
ADJUST/HZ COLL./ 04.11.1991/10:15	- Hz	- Hz	- c	
ADJUST/COMPENSATOR/ 04.11.1991/08:23	- -	- SK	- SZ	
MEASURE				
MEASURE/D-HZ-V/	- D - Ti D	- Hz Hz - Hz	- Vi Vi - Vi	Vi = V1-V4 i = 1,2,3,4,5
MEASURE/E-HZ-V/	- D E - Ti E	- Hz Hz Hz - Hz	- Vi Vi Vi - -	Vi = V1-V4 i = 1,2,3,4,5
MEASURE/E-HZ-H/	- D E Ti E	- Hz Hz - Hz	- Vi h - (h)	Vi = V1-V4 i = 1,2,3,4,5
MEASURE/HZ-V/	- -	- Hz	- Vi	Vi = V1-V4
MEASURE/TRACKING E-HZ-V/	- D E	- Hz Hz	- Vi Vi	Vi = V1-V4
MEASURE/ SET HZ/	- -	- Hz	- Vi	Vi = V1-V4

Program/Mode/Function P.I.	Type Codes			Remark
	T1	T2	T3	
SPECIAL				
SPECIAL/CONNECTING DISTANCES/	-	-	-	
.....	D	H <i>z</i>	V <i>i</i>	V <i>i</i> = V1-V4
.....	D	E	h	
SPECIAL/OBJECT HEIGHT/ point	-	-	-	Reference
.....	D	H <i>z</i>	V <i>i</i>	V <i>i</i> = V1-V4
.....	T <i>i</i>	-	-	<i>i</i> = 1,2,3,4,5
.....	E	H <i>z</i>	(h)	
.....	E	O	Z	
.....	-	H <i>z</i>	V <i>i</i>	Object point V <i>i</i> = V1-V4
.....	E	O	Z	
SPECIAL/POINT-TO-LINE DIST/	-	-	-	P1/P2
.....	D	H <i>z</i>	V <i>i</i>	V <i>i</i> = V1-V4
.....	E	H <i>z</i>	h	
.....	T <i>i</i>	-	-	<i>i</i> = 1,2,3,4,5
.....	E	H <i>z</i>	(h)	
.....	Y	X	h	Distance P1-P2
.....	Y	X	Z	Station coord
.....				Detail point
P <i>i</i>	D	H <i>z</i>	V <i>i</i>	V <i>i</i> = V1-V4
.....	Y	X	Z	
.....	T <i>i</i>	-	-	<i>i</i> = 1,2,3,4,5
.....	Y	X	(Z)	

SPECIAL/VERTICAL PLANE/	-	-	-	P1/P2
.....	D	Hz	Vi	Vi = V1-V4
.....	E	Hz	h	
.....	Ti	-	-	i = 1,2,3,4,5
.....	E	Hz	(h)	
.....	y	x	h	Distance P1-P2
.....	y	x	Z	Station coord
.....	-	Hz	Vi	Plane point Vi = V1-V4
.....	y	x	Z	



Program/Mode/Function P.I.	Type Codes			Remark
	T1	T2	T3	
COORDINATES				
COORDINATEN/ STAT. KNOWN POINT/ setting	-	-	-	
.....	-	Hz	Vi	Azimuth Vi = V1-V4
.....	m	th	ih	m = 1.000000
.....	-	Hz	Vi	Backsight meas.
.....	D	Hz	Vi	Vi = V1-V4
.....	(dl)	dq	-	i = 1...n
.....	-	-	(dz)	i = 1...n
.....	Y	X	Z	Station
.....	-	-	(mz)	
.....	m	Om	ih	
COORDINATES/ FREE STATIONING/				
.....	-	-	-	
.....	m	th	ih	m = 1.000000
.....	-	Hz	Vi	Backsight meas.
.....	D	Hz	Vi	Vi = V1-V4 i = 1,2,3,4,5
.....	(dl)	dq	-	i = 1...n
.....	-	-	(dz)	i = 1...n
.....	Y	X	Z	Station
.....	my	mx	(mz)	
.....	m	Om	ih	

COORDINATES/	-	-	-	
ELEVATION STATIONING/	-	-	-	
.....	m	th	ih	m = 1.000000
.....	D	Hz	Vi	Backsight meas.
.....				Vi = V1-V4
.....	-	-	dz	i = 1...n
.....	-	-	Z	for separate
.....	-	-	mz	elevation stat.
COORDINATES/SIDE SHOTS/	-	-	-	
.....	D	Hz	Vi	Vi = V1-V4
.....	Y	X	Z	
.....	Ti	-	-	i = 1,2,3,4,5
.....	Y	X	(Z)	
COORDINATES/SETTING-OUT/	-	-	-	
.....	D	Hz	Vi	Vi = V1-V4
.....	d1	dq	dr	
.....	dy	dx	dz	
.....	Y	X	Z	



19.5.1.3 List of all type codes

The type codes in the records described above are explained in the following table.

TC	Meaning	Decimals
c	Collimation correction	4
de	Coordinate difference in the easting Selection: E = Easting, N = Northing (control as for dy)	3
dl	- Longitudinal deviation of a measurement (stationing) - Longitudinal residual after adjustment - Longitudinal deviation for setting-out	3
dn	Coordinate difference in the northing Selection: E = Easting, N = Northing (control as for dx)	3
dq	- Lateral deviation of a measurement (stationing) - Lateral residual after adjustment - Lateral deviation for setting-out	3
dr	- Radial deviation for setting-out	3
dx	- Coord.diff. for setting-out	3
dy	- Coord.diff. for setting-out	3
dz	- Elevation deviation of a measurement (stationing) - Elevation residual after elevation adjustment (stationing) - Elevation difference for setting-out	3
e	X coordinate in the local system Selection: E = Easting, N = Northing	3
h	Elevation difference	3
i	Index correction	4
ih	Instrument height	3
m	Scale (e.g. stationing)	6
me	Mean coord. error in the Easting Selection: E = Easting, N = Northing	3
mn	Mean coord. error in the Northing Selection: E = Easting, N = Northing	3
mx	- Mean coord. error - in X direction	3
my	- Mean coord. error - in Y direction	3
mz	- Mean coord. error - in the elevation	3
n	Y coordinate in the local system Selection: E = Easting, N = Northing	3

TC	Meaning	Decimals
th	Target or reflector height	3
x	Y coordinate _ local	3
y	X coordinate _ system	3
A	Addition constant	3
C	Temperature in degrees Celsius	0
D	Slope distance	3
E	Horizontal distance	3
E_	X coordinate	3
	Selection: E = Easting, N = Northing	
F	Temperature in degrees Fahrenheit	0
Hz	Horizontal direction	4
N_	Y coordinate	3
	Selection: E = Easting, N = Northing	
O	Lateral distance (indirect elevation determination)	3
Om	Orientation (stationing)	4
P	Atmospheric pressure	
	hPa/mb	0
	Torr	0
	InMerc	1
SK	Compensator center-point: component in tilting axis direction	4
SZ	Compensator center-point: component in line of sight direction	4
T	Type of target eccentricity	
	Tv: Before _	
	Tl: Left of _	
	Th: Behind _ center	
	Tr: Right of _	
	Ts: Spatial to _	
	The offset length is stored in the associated value	
V	Vertical angle	4
	V1 zenith angle	
	V2 vertical angle	
	V3 height angle	
	V4 % slope	
X	Coordinates-Northing	3
Y	Coordinates-Easting	3
Z	Elevation	3

19.5.1.4 The Rec 500 format and the Rec Elta

The information stored in Rec 500 format records is a subset of the parameters stored in the internal Mem E format. The Rec 500 format does not yet include some of the Rec Elta specifications:

(1) Marks

The Rec 500 does not offer differing marks. One mark can be defined freely by the user. Therefore there is no code for assigning a record to a mark.

(2) Measuring units

The measuring units are not coded in the records.

(3) Number of decimals

Angle values always have 4 decimal digits and distance values 3 decimal digits.

The logo for Geodesical, featuring the word "Geodesical" in a light blue, sans-serif font. A stylized blue orbital ring or path surrounds the letter "G".

19.5.2.2 The Rec 200 format and the Rec Elta

(1) Mark

In the Rec 200 format, the 14-digit code block between positions 12 and 27 takes the place of the 27-digit P.I. in the Rec 500 format. It is subdivided into 3 fields with 2, 5 and 7 digits that are separated by spaces when the Rec 200 format is represented.

When defining the mark for this format in the Rec Elta, please note that precisely the first 14 digits of the P.I. later form the code block of the Rec 200 format. This is why these fields must not be separated by spaces. Spaces are inserted automatically at positions 14 and 20 of the Rec 200 record format for data transfer.

(2) Measuring units

There is no direct coding of the measuring units in the Rec 200 format.

(3) Computed value code

In the Rec 200 record format, there is no differentiation by means of type codes as in the Rec 500 format. Position 68 in the record only specifies globally whether it is a measured values record or a computed values record. This results in some restrictions for record conversion (see 19.6).

19.6 Record Conversion

A design goal for the Mem E was to ensure downward compatibility with the old Zeiss data formats:

- The Mem E can be used with the new or the old data formats.
- The Mem E content can be read using the new or the old data format regardless of the format used for writing.
- The Mem E detects the data format used both for input and for output.

19.6.1 New record format

The new record format is used by the hardware components:

- Rec Elta 2, 3, 4, 5,
 - Dac E,
- which use the interchangeable Mem E memory as a recording medium.

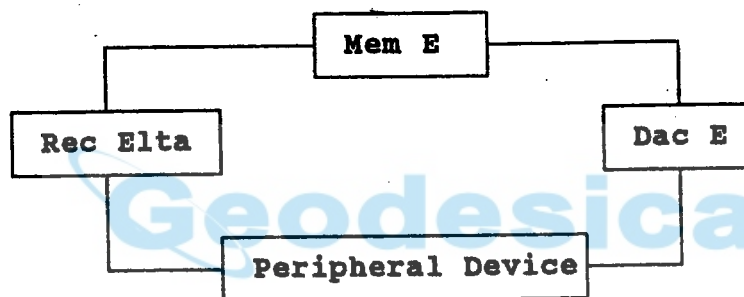

Bidirectional data transfer presents no problems as long as the conventions and the restrictions of the selected record format are observed (see 19.5.1.4 and 19.5.2.2).

19.6.1.1 Data transfer in the Rec 500 format

(1) Rec Elta -> peripheral device

a) Handling of the measuring units etc.

The data is transferred with the measuring units (angles, distances), the vertical reference system (V angle) and the coordinate system in which it was created, i.e. data transfer is not subject to the settings in the UNITS menu.

If, for example, the vertical reference system was changed during measurement - from zenith to % slope and back - , this change remains visible in the transferred data file.

b) Handling of decimal digits

In the Rec 500 record format, angle values always have 4 and distances 3 decimal digits. If you select another setting in the SET/DECIMAL DIGITS mode, this is used for data transfer. All other values (temperature, atmospheric pressure, scale etc.) always retain the number of decimals given in the table in section 19.5.1.3. This is why you should not change the number of decimal digits if the processing software expects the original number of decimals of the Rec 500 record format.

(2) Peripheral device -> Rec Elta

a) Mark

The transferred records are always assigned mark 1. When defining marks, you should therefore ensure that the P.I. format in the transferred records conforms to the conventions for mark 1.

b) Measuring units etc.

The measuring units for distances and angles (e.g. meters, grads) are not included in the records. Make sure that appropriate settings are made in the UNITS menu.

The type of coordinate system is coded in the Rec 500 records in the type codes; the same applies to the vertical reference system.

19.6.1.2 Data transfer in the Rec 200 format

(1) Rec Elta -> peripheral device

a) Handling of the P.I.

- Only a 14-digit numeric code is transferred.
- Information contained in digits 15 to 27 of the P.I. is lost.
- Non-numeric information (letters, special characters) in the first 14 digits is replaced by 0.
Spaces are set to 0.
- The code is subdivided in fields with 2, 5 and 7 digits separated by spaces.

We recommend you allow for this when defining the mark. A sample mark in the Rec 200 format is given in section 13.2.1.

b) Code

Measured value records with

- slope distance, horizontal and zenith angles
- horizontal distance, horizontal and zenith angles
- horizontal and zenith angles are assigned the measured values code.

All other data records are assigned the computed values code.

c) Handling of text lines

Lines that are unknown in the Rec 200 format are not transferred, e.g. project data, mode titles, information lines.

Since the information on the measurement procedure stored in the Mem E is lost when transferring data in the Rec 200 format, we recommend you transfer the Mem content also in the Rec 500 format or output it to a printer.

(2) Peripheral device -> Rec Elta

The following restrictions have to be observed when doing this.

- If a record has a computed values code, it is assumed that a coordinates record is involved.
- All other records are treated as measured value records. If the record contains 3 values, they are treated as slope distance and horizontal and zenith angles. If the record contains 2 values, they are interpreted as horizontal and zenith angles.
- Measuring units for distances and angles are not included in the records. They are coded internally and stored together with the values.

19.6.2 Old record format

The old record format is used by the following hardware components:

- Elta 2/20/3
- Rec 200 with Elta 46R/40/42, Elta/ETH/Eldi Series E
- Dac 100

The recording medium and thus the link between these units is the Mem 400/800. Records are stored in a fixed internal format consisting of a 14-digit code, 3 values and a measured or computed values code.

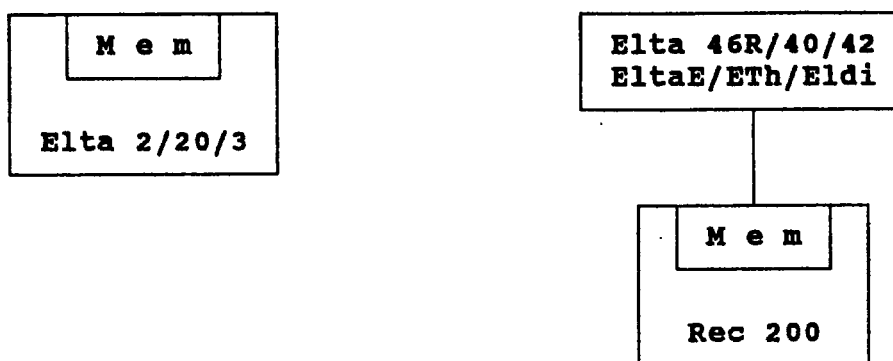
(1) Data acquisition

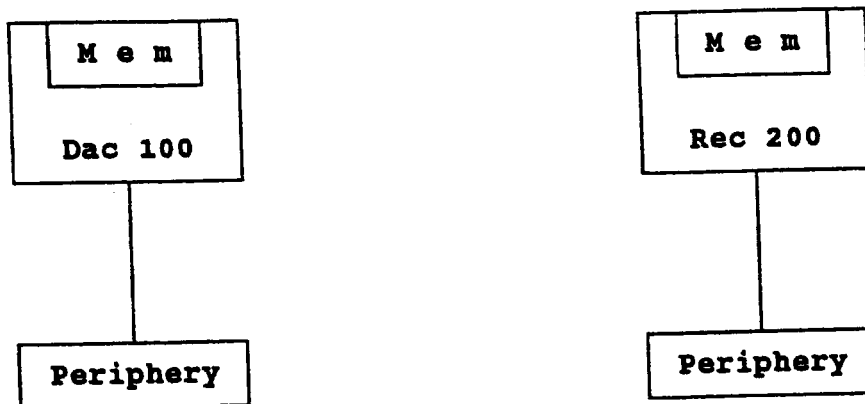
(2) Data transfer

The Mem E and the Mem E adapter can now replace the Mem 400/800 and the old data format completely

- as a data memory with a capacity of up to 1999 records,
- as a coordinates memory for online measurement and computation with the Elta 2/20/3.

In addition, the Mem E can be used as a data transfer medium between the old and the new data format.

19.6.2.1 Writing to a Mem E with the old format

When you transfer records from the Elta 2/20/3, the Dac 100 or the Rec 200 to the Mem E, it is converted there to the internal Mem E format and stored. Since the old data format only distinguishes between measured data (slope distance, horizontal direction and zenith angle) and computed data, but the computed data differs in content (horizontal distance, elevation difference, coordinates, residuals etc.), conversion to the internal Mem E format is not possible for all computed data. However, care has been taken to ensure that all data types required for further processing in the new data format can be recognized and converted.

The following rules apply to converting data from the old format to the Mem E format:

- a) The 14-digit numeric point code is used and expanded to 27 digits with spaces.
- b) The measured or computed value status is retained.
- c) Measured values with the number-of-decimals sequence 2 4 4 are assigned the type codes D Hz V; the distance unit is feet and the units for Hz and V are pseudo-units.
- d) Measured values with the number-of-decimals sequence 3 4 4 are assigned the type codes D Hz V; the distance unit is meters and the units for Hz and V are pseudo-units.
- e) Computed values with the number-of-decimals sequence 2 2 2 are assigned the type codes Y X Z and the unit is feet.
- f) Computed values with the number-of-decimals sequence 3 3 3 are assigned the type codes Y X Z and the unit is meters.
- g) Computed values with the number-of-decimals sequence 0 0 0 are assigned the type codes Y X Z and a pseudo-unit.
- h) All other data is assigned a pseudo-type code and a pseudo-unit.
- i) All uniquely convertible data is converted to the internal Mem E format and stored.
- j) All data with pseudo-type codes and/or pseudo-units that cannot be converted uniquely is stored in the same way in the Mem E.

19.6.2.2 Reading a Mem E with the old format

Before record output, the Mem E generates the old Mem format using the following rules:

- a) The first 14 digits of the P.I. are used as point code in the old Mem format. All non-numeric characters and spaces are changed to 0.
- b) Data with the type codes D Hz V is assigned the measured value code and is original measured data.
- c) All other data with measured value codes or computed value codes retains the associated status.
- d) Data with the type codes Y X Z and the unit "feet" is converted to computed data with 2 decimal digits, and data with the unit "meters" to computed data with 3 decimal digits.
- e) Data with the type codes Y X Z and a pseudo-unit is converted to computed data without decimal digits.
- f) Data with pseudo-type codes and/or pseudo-units is used unchanged.
- g) In the old Mem format, measured and computed data can have a maximum of 10 significant digits including a minus sign and a decimal point. For converting larger values entered or created in the Rec Elta, leading digits are truncated. The valid range for coordinates is -999 999.99 feet to 9999 999.99 feet and -99 999.999 meters to 999 999.999 meters.

(1) Output to the Elta 2/20/3

All stored records can be accessed by entering the address.

(2) Output to a peripheral unit with the Rec 200

The Rec 200 retrieves the record from the Mem E, converts it to the fixed Rec 200 format, and transfers it to the peripheral device.

Address calling in the Rec 200 is possible with 4 digits.

(3) Output to a peripheral unit with the Dac 100

The Dac 100 retrieves the record from the Mem E, converts it to the individually programmed Dac 100 format, and transfers it to the peripheral device.

Since the Dac 100 only uses 3-digit addresses, data transfer can be started only as of an address < 1000 . Transfer then proceeds in the usual way and is terminated after the transfer of the last stored record (maximum 1999) or by manual abortion.

(4) Deleting the Mem E in the old data format

The commands for deleting the whole Mem E content are unchanged for all devices using the old data format.

Caution:

Each Dac 100 was individually programmed before delivery regarding record format and data transfer control. Because of the differences between the old and the new Mem format, complete downward compatibility cannot be achieved. The delivered Dac 100 are different, too, as to the hardware. This is why we cannot guarantee that conversion from the old Mem format to the Mem E format and back and the transfer of Dac 100 or Rec 200 data will always be error-free in all possible cases. We therefore refer to the option to output the Mem E content to a PC through the Rec Elta or the Dac E in the Rec 500 format, to save the data and then to convert it to the Dac 100 format with the DACCONVD (708046) or DACCONVE (708047) program. This conversion is also possible in the other direction. The DACCONV program may have to be matched to the individual Dac 100 format.

19.7 Data Transfer Programs from Carl Zeiss

Data transfer programs are available from Carl Zeiss for some computer types:

Computer	Name	Language	Cat. Number
DOS-comp. PC	RECPCD	German	708044
	RECPCE	English	708045
Siemens MX Series	CZMX	German	708058
VAX/MicroVAX	REC500VAX	English	708059

Current information is given in the valid price list.

19.8 Linkage to Office Software

After data transfer, the field survey data is available in an ASCII file for the office computer - e.g. a PC. A generally accepted data interchange format such as the DXF format for CAD systems or the RINEX format in the GPS world does not yet exist for field survey systems. As a rule, the data cannot be used in the manufacturer's format (here e.g. the Rec 500 format) with the office software. It must therefore be converted to the required internal format.

This step has been taken by most of the software companies operating on the German market.

Such a conversion program performs two basic steps:

- (1) Only the information required for further processing is read from the data records.
- (2) The retrieved information is arranged in such a way that the processing software can recognize and process it.

The retrieval criteria for filtering are the type codes of the Rec 500 records. To group all coordinates records of a survey, for example, a check is made after reading a record from the source file if the type codes Y, X, Z exist in the corresponding locations of the data string (see 19.5.1.1). If not, the next record is read; if yes, the data string is rearranged in the required way and stored in the destination file.

The procedure is similar if only the original measured data D, Hz, V or Hz, V is required. In this case the problem could occur that every record must also be assigned the target height, addition constant, temperature, atmospheric pressure etc., for example. These parameters are always stored in the source file when they are changed. The data conversion program must then also recognize such records by means of the type codes and add them to the following measurement records in the desired form. Whenever a new data record with such parameters is detected in the source file, the following measured data is assigned the new values.





 **Geodesical**

Appendix

A 1 Formulae

A 1.1 Correction and Computing Formulae for Angle Measurement

(1) V angle measurement

$$V_k = V_0 + i + SZ_a$$

where:

V_0 = Uncorrected V circle reading, averaged from diametrical readings in the Rec Elta 2

i = Index correction

SZ_a = Current vertical axis tilt in the sighting direction

(2) Hz direction measurement

$$Hz_k = Hz_0 + Hz_1 + Hz_2 + A$$

where:

Hz_0 = Uncorrected Hz circle reading, averaged from diametrical readings in the Rec Elta 2

Hz_1 = $c/\sin(V_k)$ - collimation correction

Hz_2 = $SQ_a/\tan(V_k)$ - correction for vertical axis tilt in the tilting axis direction

A = Circle shift for orientation, e.g. Set HZ (5.7)

A 1.2 Basic Formulae for Distance Measurement

Each distance is computed from the following basic components:

$$D_k = (D_0 + D_i + A) * M_i$$

where:

D_k = Corrected distance

D_0 = Uncorrected distance

D_i = Internal corrections

A = Addition constant

M_i = Effect of meteorological data

The effect of the meteorological data M_i is computed as follows:

$$M_i = (1 + (n_0 -) * 10^{-6}) * (1 + (a * T * T) * 10^{-6})$$

where:

n	=	$(79.146 * P) / (272.479 + T)$	= Refraction index
n_0	=	255	= Group refraction index
P	=	Atmospheric pressure in hPa or mbar	
T	=	Temperature in degrees Celsius	
a	=	0.001	= coefficient for vapor pressure correction

Carrier wavelength	0.86 microns
Modulation wavelength	20 m
Precision scale	10 m

A 1.3 Distance Computation and Reduction in the Elta

The slope distance displayed in the Elta is the distance between the Elta tilting axis and the prism.

It is computed from the measured slope distance and the entered scale:

$$D = D_k * M$$

where:

D	=	Displayed slope distance
D_k	=	Basic distance according to 1.2
M	=	Scale

The elevation difference and the horizontal distance are computed as follows:

$$dh = dh_1 + dh_2$$

where:

dh_1	=	$D_k * \cos (Z)$
dh_2	=	$(D_k * \sin (Z)) * (D_k * \sin (Z)) * 6.8 * 10^{-8}$
dh_2	=	Effect of earth curvature and refraction ($k = 0.13$)

$$E = (E_1 + E_2) * M$$

$$\begin{aligned} E_1 &= D_k * \sin (Z + R) \\ R &= 6.5 * 10^{-7} * D_k * \sin (Z) \\ &= \text{Effect of refraction} \\ E_2 &= - 1.57 * 10^{-8} * dh * D_k * \sin (Z) \\ &= \text{Effect of earth curvature} \end{aligned}$$

where:

$$\begin{aligned} D_k &= \text{Corrected slope distance} \\ Z &= \text{Measured zenith angle [grads]} \\ M &= \text{Scale} \\ dh &= \text{Computed elevation difference} \\ E &= \text{Computed horizontal distance} \end{aligned}$$

Scale computation for reduction to MSL:

$$\begin{aligned} m &= \frac{R}{R+h} & R &= \text{Earth radius (6370 Km)} \\ S_2 &= S_1 * m & h &= \text{Elevation above MSL (Km)} \\ & & S_1 &= \text{Measured distance at the elevation h} \\ & & S_2 &= \text{Distance reduced to MSL.} \end{aligned}$$

This computation formula is used for all earth radii.

Remark:

When a scale is computed in a stationing routine, reduction to the mapping system (e. g. Gauß-Krüger reduction) is performed in addition to elevation reduction.

A 1.4 Elta Check on Calibrated Distances

All measured distances are always corrected in the Elta for

- the entered scale (see 6., INPUT Program),
- the entered addition constant (see 6., INPUT Program),
- the effect of the pressure and the temperature (see 6., INPUT Program),
- internal values.

This is why the current scale, addition constant, pressure and temperature have to be entered in the Rec Elta before calibration measurement.

This ensures that all corrections are applied completely and correctly in the Elta.

This method also allows direct actual/should-be comparison for given distances.

If you want to correct for the atmospheric conditions externally, the temperature should be set to 20°C and the atmospheric pressure to 944 hPa in the Rec Elta. The internal correction then is zero (see 14., SWITCHES: Auto T/P: Off)

For frequency-checking the Rec Elta by measuring the frequency of the sighting beam, note the following:

If the environmental temperature of the Rec Elta deviates from the calibration temperature of 20°C, the emitted frequency does not correspond to the nominal frequency of 14 985 800 Hz. The resulting difference is numerically applied in the Rec Elta as a correction to all measured distances.

A 1.5 Prism and Addition Constants

All Zeiss rangefinders are matched to the Zeiss reflectors so that they have the addition constant 0.

For measurement with reflectors made by other manufacturers, the addition constant, if any, can be determined by measurement and entered in the Rec Elta.

Another option consists in computing an addition constant from the known prism constant of the reflector used and to enter it in the Rec Elta. This prism constant can be computed from the geometrical size of the prism, the type of glass and of the location of the mechanical reference point.

The prism constant determined in this way for Zeiss reflectors is 35 mm.

The following relationship exists between the addition constant A_{CZ} for Zeiss instruments, the prism constant P_{CZ} for Zeiss reflectors, and the prism constant P_f for reflectors made by other manufacturers:

$$A_{CZ} = P_{CZ} - P_f$$

Example:

Zeiss reflector Prism constant $P_{CZ} = 35$ mm

Other reflector Prism constant $P_o = 30$ mm

Addition constant for Zeiss instruments
used with this other reflector

$A_{CZ} = + 5$ mm

At the Rec Elta the addition constant + 0.005 m must be set (see 6., INPUT Program).

A 2 List of Soft Keys

This list contains a brief survey of all soft keys. Detailed information is given in the corresponding program part.

2 different types can be distinguished:

1. Soft keys that initiate a function with or without return to the calling location.
2. Soft keys that display a switch setting and allow changing it.

In some modes, more than 10 soft keys can be used.

- The line displayed first contains the 9 most important soft keys.
- The second line can be activated with soft key 0 "→ 2".
- To return to line 1, use soft key "→ 1".
- Soft key line 1 is always displayed after measurement.



A 2.1 Alphabetic List

Designation	Meaning
A→A	Delete, transfer or add an additional code from address i to address j
ACd	Add an additional code to a series of records in the Editor
Adr	Delete, transfer or add an additional code at a given address
?Ad	Search memory for address
Add	Additional measurement for stationing
All	Delete, transfer or add an additional code - all addresses
Bat	Display the battery condition
CIC	Cancel the point code C within the point identification (P.I.)
CII	Cancel the additional information I within the point identification (P.I.)
Col	Branch from the initial menu to a measurement program for determining the collimation correction and return
Com	Branch from the initial menu to a measurement program for compensator center-point determination, and return
Con Cno	Compensation on/off
Cpy	Copying of a data line
D→M	Transfer data from disk to Mem
Dat	Include the date in an information line (Inf) or a project data line
Del	Delete a file
Dir	Load a new directory

Designation Meaning

D:N,D:L,D:R	Select the measurement mode for the rangefinder
dlq, dxy	Store deviations in longitudinal and lateral directions, coordinate differences
YXZ, ALL	Store actual coordinates or all elements
D/T	Optional display of the date and time in the initial menu of a measurement mode
DTh, Th	Toggles between D-Hz-V (E-Hz-V) measurement and Hz-V measurement
Edt	Editing of records with the Editor
Ecc	Offset entry
Fl	Computing of area
Frm	Format a disk
Ind	Branch from the initial menu to a measurement program for determining the index correction, and return
Inf	Input of an information line
Ino lon	Switch for incrementing the point number
Inp	Input of coordinate records
LAd	Displays the last address, delete or transfer only the last address
M→D	Data transfer from Mem to disk
Mrk	Scrolling in a predefined list of marks to support P.I. input.
Nam	Rename a file
?Nr	Select a file according to its number
P-A	Set a point number block

Designation Meaning

PE→	Increase the point number size
PE	Reduce the point number size
Pt.	Delete or transfer a given point number
?Pt	Search in memory for a point number
↓?	Continue searching
?PI	Search memory for records with a given partial point identification Delete or transfer all records with a given partial point
P→P 1→P	Connecting distances switch
P→P	Delete or transfer from point number i to point number j
Rno, R-M, R-C, RMC	Recording on/off
Spc	Set a space
Sta	Display and optional storage of the initial instrument condition (units, input values, instr. error correc.) identification
Tab	Set a Tab
Tim	Include the time in an information line (Inf) or a project data line
Wno, Won	Angle display in the setting out program ON/ OFF
→2 →1	Call the following (preceding) soft key line
-■-	Place holder
-♦-	Wildcard

A 2.2 Assignment to the Application Programs

Program	1	2	3	4	5	6	7	8	9	0
Standard call	-			Inp		LAd	?Ad	?Pt	?PI	?↓
Initial menu	-	D/T	Sta	Bat	Com	Ind	Col			
Input of an information record	-		CLI		Tim		Dat	Mrk		
Index/line of sight	-		ClC	ClI		R-C			Mrk	Con
EDITOR										
Display	-	Del	Edt	Inp	ACd	LAd	?Ad	?Pt	?PI	?↓
?PI	-	ClC	ClI						Mrk	-- --◆-
Inp	-	ClC	ClI	Ino			Inf		Mrk	
Edt	-	ClC	ClI						Mrk	
Del	-	All		Adr	A→A	LAd		Pt.	P→P	?PI
ACd Input Selection	-	ClC	ClI						Mrk	-- --
	-			Adr	A→A	LAd		Pt.	P→P	?PI
Transfer	-	All		Adr	A→A	LAd		Pt.	P→P	?PI
Diskette	-	D→M	M		Str	Nam	Frm	Dir		?Nr
Mark setting	-	Tab	Spc		P-A	PE←	PE→		Tim	Del

Program	1	2	3	4	5	6	7	8	9	0
---------	---	---	---	---	---	---	---	---	---	---

Measure

D, Hz, V	—	ClC	ClI	Ino	R-M	Ecc	Inf	D:N	Mrk	Con	→ 2
	—	DTh				Cpy			Mrk		→ 1
Hz, V	—	ClC	ClI	Ino	R-M		Inf		Mrk	Con	
	—										
E, Hz, V	—	ClC	ClI	Ino	R-C	Ecc	Inf	D:N	Mrk	Con	→ 2
	—	DTh				Cpy			Mrk		→ 1
Tracking E, Hz, V	—	ClC	ClI	Ino	R-C		Inf	D:N	Mrk	Con	
	—										
E, Hz, H	—	ClC	ClI	Ino	R-C	Ecc	Inf	D:N	Mrk	Con	→ 2
	—					Cpy			Mrk		→ 1
Set Hz	—	ClC	ClI		R-M		Inf		Mrk	Con	
	—										

Special

Connecting distances	—	ClC	ClI	Ino	R-C	P-P	Inf	D:N	Mrk	Con	→2
	—	Fl									→1
Object height	—	ClC	ClI	Ino	R-C	Ecc	Inf	D:N	Mrk	Con	
	—										
Point-to-line distance	—	ClC	ClI	Ino	R-C	Ecc	Inf	D:N	Mrk	Con	
	—										
Vertical plane	—	ClC	ClI	Ino	R-C	Ecc	Inf	D:N	Mrk	Con	
	—										

Program	1	2	3	4	5	6	7	8	9	0
Coordinates										
Stationing										
- Call			Inp		LAd	?Ad	?Pt	?PI	?↓	
- Set Hz	ClC	ClI		R-M		Inf		Mrk	Con	
- Orient. Coord										
- Call			Inp		LAd	?Ad	?Pt	?PI	?↓	
- Measure	DTh			R-M			D:N	Mrk	Con	
Free Stat.										
- Call			Inp		LAd	?Ad	?Pt	?PI	?↓	
- Measure	DTh			R-M			D:N	Mrk	Con	
Elev. Station.										
- Input Pt.	ClC	ClI				Inf		Mrk		
- Call			Inp		LAd	?Ad	?Pt	?PI	?↓	
- Measure				R-M			D:N	Mrk	Con	
Side shots	ClC	ClI	Ino	R-C	Ecc	Inf	D:N		Con	-2
					Cpy			Mrk		-1
Setting-out										
- Call			Inp		LAd	?Ad	?Pt	?PI	?↓	
- 1st measurement				R-C	dlq	Wno	D:N		Con	
- Iteration				R-C	dlq	Wno	D:N		Con	

A 3 Technical Data

A 3.1 Elta 2 and 3

	Elta 2	Elta 3
Precision		
Angle measurement		
Standard deviation as per DIN 18723		
Hz:	0.6" / 0.2 mgrads	2" / 0.5 mgrads
V :	0.6" / 0.2 mgrads	2" / 0.5 mgrads
Distance measurement		
Standard deviation	2 mm + 2 ppm	3 mm + 3 ppm
Telescope		
Aperture	45 mm	
Telescope length	170 mm	
Field of view at 100 m	2.4 m	
Shortest sighting	1.2 m	
Magnification	30 x	
Angle measurement		
Hz and V circles	Electronic, incremental, diametrical (only Elta 2) Zero-point setter for Hz and V	
Measuring units	360° (DMS) 360° (DEG) 400 grads 6400 mils	
Vertical reference system	Zenith angle Elevation angle Vertical angle Percent slope	
Least display unit	1", 0.1 mgrad, 0.01 mil	1", 0.2 mgrads, 0.01 mil
Compensator		
Type	Two-axis liquid compensator	
Range	± 2' 40" or 48.0 mgrads	
Setting accuracy	0.6" or 0.2 mgrads	1" or 0.3 mgrads

	Elta 2	Elta 3
Distance measurement		
Type	Electro-optical, infra-red light, modulated	
Send/receive optics	Coaxial, in telescope	
Range		
with 1 prism	1.8 km	1.6 km
with 3 prisms	2.5 km	2.0 km
Maximum	6.0 km	5.0 km
Display		
	Four-line LCD in the Elta in telescope positions I and II	
	Illumination under program control	
Sensors		
	Automatic sensing of temperature and atmospheric pressure	
Audible signal generator		
Power supply		
	NiCd battery pack, 4.8V, 1.8Ah	
	Operating time approx. 6 to 8 hours	
Levelling		
Circular level	10' / 2mm at the tribrach	
Tubular level	30" / 2mm	
Clamps and fine motions		
	Coaxial, parallel axes	
Centering		
	Zeiss forced centering system	
	Wild forced centering system	
Temperature range		
	- 20 °C to + 50 °C	
Dimensions		
W / H / D	232 x 270 x 182 mm	
Tilting axis height	158 mm (DIN spigot)	
	196 mm (WILD centering system)	
Weights		
Instrument incl. batt.	5.9 kg	
Case	2.5 kg	

A 3.2 Elta 4 and 5

	Elta 4	Elta 5
Precision		
Angle measurement		
Standard deviation according to DIN 18723		
Hz:	3" / 1.0 mgrad	5" / 2.0 mgrads
V:	3" / 1.0 mgrad	5" / 2.0 mgrads
Distance measurement		
Standard deviation	3 mm + 3 ppm	5 mm + 3 ppm
Telescope		
Aperture	45 mm	35 mm
Telescope length	170 mm	170 mm
Field of view at 100 m	2.4 m	3.3 m
Shortest sighting	1.2 m	1.9 m
Magnification	30 x	22 x
Angle measurement		
Hz and V circle	Electronic, incremental, zero-point setter for V	
Measuring units	360° (DMS) 360° (DEG) 400 grads 6400 mils	
Vertical reference system	Zenith angle Elevation angle Vertical angle Percent slope	
Least display unit	2", 0.5 mgrads, 0.01 mil	5", 2 mgrads, 0.01 mil
Compensator		
Type	One-axis compensator	
Range	± 2' 40" or 48.0 mgrads	
Setting accuracy	0.5" or 0.15 mgrads	

	Elta 4	Elta 5
Distance measurement		
Type	Electro-optical, infra-red light, modulated	
Send/receive optics	Coaxial, in telescope	
Range		
with 1 prism	1.2 km	1.0 km
with 3 prisms	1.6 km	1.5 km
Maximum	4.0 km	3.5 km
Sensors	Automatic sensing of temperature and atmospheric pressure	
Audible signal generator		
Power supply	NiCd battery pack, 4.8V, 1.8Ah Operating time approx. 6 to 8 hours	
Levelling		
Circular level	10' / 2mm at the tribrach	
Tubular level	30" / 2mm	
Clamps and fine motions	Coaxial, parallel axes	
Centering	Zeiss forced centering Wild forced centering	
Temperature range	- 20 °C to + 50 °C	
Dimensions		
W / H / D	232 x 270 x 182 mm	
Tilting axis height	158 mm (DIN spigot) 196 mm (WILD centering)	
Weights		
Instrument incl. batt.	5.9 kg	
Case	2.5 kg	

A 3.3 Rec E**Display**

4 lines with 40 characters each
Graphics capability (240 x 38 pixels)
Automatic contrast control
Wide viewing angle (approx. 45°)

Keyboard

24 single-function keys
Color coding of key groups
Alphanumeric input
Variable soft keys
Menu and interactive displays

Recording

Interchangeable data memory Mem E
- Non-volatile memory without buffer battery
- Data retention time at least 1 year
- Memory capacity approx. 2000 records
Online via RS 232 C / V24 interface

The logo for Geodesical, featuring the word "Geodesical" in a light blue, sans-serif font. A stylized blue orbital ring or path surrounds the letter "G".

A 4 Error Messages

A 4.1 Elta Error Messages

The following error messages can appear in the display:

BATT	Battery low. Change or charge battery.
Error 01	ROM defective
Error 02	RAM defective
Error 03	NV-RAM defective
Error 04	NV-RAM defective
Error 05	NV-RAM defective
Error 06	NV-RAM defective
Error 40	Error in rangefinder section
Error 41	Error in rangefinder section
Error 42	Error in rangefinder section
Error 43	Error in rangefinder section
Error 47	Error in rangefinder section
Error 50	Error in rangefinder section
Error 51	Error in rangefinder section
Error 52	Error in rangefinder section
Error 53	Error in rangefinder section
Error 54	Error in rangefinder section
Error 60	Error in V angle section
Error 80	Error in compensator
Error 81	Error in data transfer section
Error 82	Error in data transfer section

Errors 01 to 06 require servicing.

Error with error numbers ≥ 40 can generally be reset with ENT. If the error display persists, servicing is required.

Note:

If the instrument does not respond to key pressure in any mode, you can turn it off by removing the battery cartridge.

A 4.2 Rec Error Messages

Error 202	Compensator operating range exceeded ($\pm 2' 40''$)
Error 401 - 409 Error 4WR	Error in the Mem (servicing required) Write error in the Mem (service), or save Mem content and reinitialize
Error 4RD	Read error in the Mem (service), or save Mem content and reinitialize
Error 460 - 499	Error in Rec E \rightarrow Mem data transfer (service)
Error 501 - 509	Error in the Rec E (service)
Error 550 - 579	Error in the Rec \leftrightarrow Elta data transfer
Error 581	I/O receive error (PARITY, FRAMING, OVERRUN)
Error 582	Rec cannot send
Error 584	TIMEOUT because CTS/XON is missing
Error 585	TIMEOUT for data transfer
Error 586	Dialog opening error (only software dialog) Rec \rightarrow computer: "B" did not arrive after "A" Computer \rightarrow Rec: 1st character is not "A"
Error 587	TIMEOUT during data reception
Error 588	"B" did not arrive in the dialog loop (see also 586)
Error 589	Format error in the data string from the computer (wrong separator)
Error 590	Character error in the data string from the computer (too many DP, blank in wrong place)
Error 591	Non-alphanum. character in PI
Error 593	No decimal point in the distances or angle value from the computer
Error 595	Service
Error 599	Data transfer aborted by the computer

A 5 Measurement Preparation

A 5.1 Transport

Protect the instrument against hard shocks and sudden temperature changes during transport, and turn the instrument off.

Short distances:	Instrument on tripod
Long distances:	Instrument in the case

Allow sufficient time for the instrument to adapt to the environmental temperature. A temperature difference of 1° C means an acclimatization time of 1 minute.

A 5.2 Instrument Setup

Extend the tripod legs to a convenient length and tighten the tripod clamps.

Screw on the instrument in the center of the tripod head with the tribrach screws in their center positions.

Centering and levelling:

- Position the tripod roughly above the station and tread the tripod legs moderately into the ground with the tripod head approximately level.
- Coarse centering:
Center the circle of the optical plummet (22) on the station with the tribrach screws (19).
Focus the circle by turning the eyepiece.
Focus the station mark by pushing in or pulling out the eyepiece of the optical plummet.
- Coarse levelling:
Center the circular level by changing the tripod leg length.
- Precision levelling:
Center the tubular level by center-point determination.
Center-point determination:
 - . Set the axis of the tubular level parallel to the line connecting two tribrach screws
 - . Center the level with these two tribrach screws
 - . Turn the instrument through 180° or 200 grads
 - . Eliminate half the bubble error with the tribrach screws (center-point)

- . Turn the instrument through 90° or 100 grads and center the level with the third tribrach screw
- . Turn the instrument around the vertical axis. There must be no bubble error; if there is, repeat center-point determination
- Precision centering:
Shift the tribrach on the tripod head until the circle of the optical plummet covers the mark. Tighten the tribrach mounting screw (30).
- Repeat precision levelling and precision centering, if required, until the tubular level bubble always returns to the initial position also after turning the instrument, and the station mark always remains in the circle figure.

Humid weather and rain:

- Cover the instrument with the plastic hood before long breaks.
- Wipe the instrument with an absorbent cloth and allow it to dry in the open case in a warm room.

Sun:

- Use a sun shade in hot sun light.

A 5.3 Telescope Adjustment and Sighting

- Focussing the reticle:
Sight a bright, neutral surface (sky, white paper)
Turn the eyepiece (9) until the reticle is in focus
- Focussing the target:
Turn the focussing ring (7) until the target is in focus.
- Parallax check:
Move your head slightly in front of the eyepiece. There should be no relative movement between the target and the reticle; check the focussing, if required.

Warning:

Never sight the sun or a strong light source to avoid eye injury.

A 6 Power Supply

The Rec Elta is supplied with power from a NiCd battery (708152). This battery can be recharged with the LG 9 battery charger (708150).

The battery charger may be used only for charging the above battery and must be protected against humidity.

It can be set to 110 V or 220 V. Before using it, check the voltage setting at the slide switch at the bottom of the battery charger.

The green power indicator lights when you connect the battery charger to the power network. Place the battery in the charger cradle and fasten it with the screw. The yellow indicator now lights in addition; it indicates that a trickle charging current is flowing. Trickle-charging a dead battery takes 60 hours.

Press the start button for normal charging; the yellow indicator goes dark and the red indicator comes on. The normal charging time is 12 hours. After normal charging, the battery charger automatically switches to trickle-charging (yellow indicator).

If you inadvertently press the normal charge start button for a fully charged battery, you can abort charging to protect the battery against overcharging by removing the battery cassette from the charger and pulling the power connector for about 30 seconds. After reconnection, a trickle-charging current again flows (yellow indicator).

After a network power failure, the battery charger automatically resumes charging and maintains the selected 12-hour charging time.

In the battery charger LG 9 the battery can't be overcharged.

Hints on proper handling of rechargeable batteries:

- A new battery should be charged 2 to 3 times in the 12-hour normal charging mode before using it for the first time to enable it to reach its full capacity.
- In daily use, charge the battery (12 hours) only if the battery indicator in the Elta indicates that the battery voltage is low (after approx. 6 to 10 hours of operation).
- Charge slightly discharged batteries only with the trickle-charging current (60 hours mode).
- Do not deep-discharge batteries by shorting their contacts.

A 7 Adjustment

A 7.1 Collimation Error Elimination

A collimation error exists if the line of sight of the telescope is not vertical to the tilting axis of the telescope. This error affects angle measurements in only one telescope position.

The error is normally measured in the ADJUST program (see 7.5) and automatically compensated if it does not exceed $\pm 2'40''$.

If it is greater than $\pm 2'40''$ the reticle of the telescope has to be adjusted manually.

To do this, unscrew the ring cap (8), sight a well-defined target with an approximately level line of sight in both telescope positions, and determine the corresponding directions in the HZ-V mode of the MEASURE program (see 9.5). Average the directions and set the average with the Hz fine motion. Then use the adjustment screws to shift the reticle until it covers the target.

Loosen the opposite screw before tightening an adjustment screw. Both adjustment screws must be tight after adjustment completion.

Notice:

Do not change the adjustment in the vertical direction. Mechanical elimination of the index error may be performed only by the service.

A 7.2 Alidade Level Adjustment

Set up the instrument in an absolutely stable way, i. e. clamp the instrument in the tribrach with clamp (28) and fasten the tribrach on a stable tripod with screw (30).

To adjust, turn the instrument so that the alidade level (12) is parallel to the line connecting two levelling screws, and center the bubble with one of the two levelling screws.

Then turn the instrument through a right angle so that the level points to the third levelling screw. Use this levelling screw to center the level as precisely as possible.

After turning the instrument in the opposite direction, eliminate half the bubble error with the third levelling screw and the other half with the level adjustment screw.

Observe the following during adjustment:

- Avoid one-sided level heating.
- Loosen the opposite screw before tightening an adjustment screw.
- After adjustment completion, both adjustment screws must be tight.
- The level should center properly after adjustment in any instrument sighting direction.

Adjust the alidade level very carefully and check it regularly.

The alidade level of the Rec Elta 2 and 3 can also be adjusted directly after center-point determination and precise levelling using the compensator display in the ADJUST program (7.6) or with the LEV key.

A 7.3 Optical Plummet Adjustment

Optical plummets are installed in the vertical axis of the instrument or attached to the tribrach (type EWL), or are available as insertion plummets.

The line of sight of the optical plummet is the optical continuation of the vertical axis.

The optical plummet in the instrument and the optical plummets that can be inserted in the tribrach have the same adjustment conditions and are equivalent in testing and adjustment.

First check the levels (see section A 7.2).

Then shift the reticle in the plummet telescope with the adjustment screws until the target figure remains in the center after a 180° turn of the plummet in the vertical axis.

If you use an optical plummet attached to the tribrach, the nominal line of sight can be determined with the plumb bob. You can also turn the whole tribrach through $2 \times 120^\circ$ on the tripod head depending on the shape of the baseplate. Mark the initial position on the tripod head to ensure that its center can be returned to this point after the rotation. Level again after rotation.

A 7.4 Level Adjustment at Accessories

Levels serve to align the instrument or parts of instruments relative to the direction of the force of gravity, e.g.:

- Vertical axes in the vertical
- Optical plummet collimation in the vertical
- Forced centering systems in the horizontal
- Telescope line of sight in the horizontal
- Prism rods in the vertical

Checking the adjustment and adjustment itself very simply done for levels on a tribrach, for tubular and circular levels of instruments, and for insertion plummets. After precise bubble centering to the scale or centering circle of the level and 180° rotation in the vertical axis, the bubble error is twice the adjustment error; half of it can be eliminated with the level adjustment screws and the remainder with the tribrach levelling screws.

The circular level at the centering rod is also "reversible" and has to be checked and adjusted as described. Instead of tilt setting with the tribrach screws, adjust the centering rod vertically by shifting the tribrach on the tripod head.

The "non-reversible" level at the tribrach can be adjusted by inserting a device with a vertical axis in the forced centering system. When its level is adjusted and centered, the bubble error of the tribrach level can be eliminated completely with its adjustment screws.

The circular level at the prism rod can be checked and adjusted after the rod has been set up vertically with other means, e. g. rod in tripod, with plumb bob or with the theodolite by means of the telescope.

If you have a rod tripod with 3 legs, "adjustment by reversing", see above, is possible by rotation in the tripod.

A telescope level can be adjusted with vertical circle readings and setting after the vertical index error has been determined. If the V circle readings add up to precisely 360° when you sight the same target in telescope positions I and II, the telescope line of sight is horizontal for a V circle reading of 90° and the telescope level must center, or be centered with its adjustment screws.

A 8 Accessories

A 8.1 Description

The whole system features a uniform height of the tilting axes above the tribrach mount:

158 mm for DIN spigot
196 mm for Wild centering

The height of the tilting axis of the KTR or the target above the mounting surface is 100 mm.

(1) Tripod

The S 24 tripod (Cat. No. 70 72 22) is supplied with the instrument.

During use, make sure that its wooden parts are tight; the upper joints and the tips have adjustable screws.

The friction of the leg joints can be adjusted with the 6 hex socket screws directly below the axes. When you lift the tripod at its head, the legs should fold slowly.

(2) Tribrach

The ED or EW tribrach is supplied with the instrument. They differ only in forced centering: DIN spigot (ED) or Wild forced centering system (EW).

The levelling screws are self-adjusting, i.e. adjustment is not required. The circular level can be adjusted with 2 capstan screws (see section A 7.4).

(3) Reflectors

The reflectors for distance measurement form a modular system.

(4) Prism rod

The prism rod for setting up tiltable reflectors has an adapter. The 5/8 inch thread atop the telescopic rod with graduation can be screwed off, turned round and screwed in again.

Then there is an M 8 thread for a single reflector (not tiltable) at the top.

The graduation indicates the height of the prism above the rod tip in both cases.

The extension rod can be screwed between the telescopic rod and the adapter. One meter then has to be added to the height read.

The screw-off tip of the prism rod provides the option to attach an extension rod at the lower part of the prism rod.

The logo for Geodesical, featuring the word "Geodesical" in a light blue, sans-serif font. A light blue orbital ring is positioned around the letter "G".

A 8.2 Catalog Numbers

(1) Power supply

708152	Battery pack 4.8 V, 1.8 Ah
708150	LG 9 battery charger 90-120V, 185-264V, 50/60Hz for 708152

(2) Tripods

707222 - 9901	S 24 tripod
709551 - 9901	Protective cap and carrying strap for S 24
707286	Prism rod with graduation
707287	Prism rod extension
707288	Prism rod tripod

(3) Tribachs

707125	ED tribrach for Zeiss forced centering system
707126	EW tribrach for Wild forced centering system
707127	EWL tribrach with attached optical plummet

(4) Optical plummets

706137	Optical plummet V for ground points, for vertical viewing, for insertion in ED tribrach
706138 - 9901	Optical plummet N for ground points, for horizontal viewing, for insertion in ED tribrach
706139 - 9901	Optical plummet NZ for ground and roof surveying points, for horizontal viewing (in ED tribrach)
706141	Optical plummet VW for ground points, for vertical viewing, for insertion in EW tribrach
706142	Optical plummet NW for ground points, for horizontal viewing, for insertion in EW tribrach
706143	Optical plummet NZW for ground and roof surveying points, for horizontal viewing (EW tribrach)

(5) Targets

706705	Target E
706814	Target E with adapter for use in Zeiss forced centering system
706815	Target E with adapter for use in Willd forced centering system
706706	Target for use on the KTR 1

(6) Reflectors

706765	KTR 1 N reflector, tiltable (with 1 prism), for use on prism rod 707286, extension 707287 or spigot 706767 or Wild adapter 704538
706767	Adapter for inserting a KTR 1 in tribrachs with Zeiss forced centering system
704538	Adapter for inserting a KTR 1 in tribrachs with Wild forced centering system
706762	ETR 1 N reflector, rigid (with 1 prism), for use on prism rod 707286 or extension 707287
706763	ETR 1 S reflector, rigid (with 1 prism), for use on prism rod 707286 or extension 707287
706771	Corner-sighting set for ETR 1, consisting of: Corner-sighting rod and sighting collimator
706824	Corner-sighting reflector, complete, consisting of: ETR 1 N, corner sighting rod and sighting collimator
706769	T 3 traverse for converting a KTR 1 to a triple reflector
706770	T 7 traverse for converting a KTR 1 to a 7x reflector
706816	T 19 traverse for converting a KTR 1 to a 19x reflector

(7) Special accessories

704116	Steep sighting prism
704105 - 9901	Ninety-degrees eyepiece F
704137	Lens filter for sun observation
706334	Reticle illumination (reflector sighting under adverse illumination conditions)
706776	ETR 1 adapter 106 mm for using an ETR 1 on prism rod 707281 (not E series)
707264	KTR 1 adapter 6 mm for using a KTR 1 on prism rod 707281 (not E series)
706768	Adapter 181 mm for using a KTR 1 in the Zeiss tribrach

(8) Cases

709617	Accessories case for: two ED or EW tribrachs, two adapters for DIN or Wild forced centering, three KTR 1 reflectors, four ETR reflectors, two T 3 traverses, one T 7 traverse
708566	Case for the Rec Elta

(9) Recording and data transfer

708192	Mem E memory
708194	Dac E data converter
708140	Mem E / DAC 100 adapter for data processing in the Elta 2/Mem 800/DAC 100 system

The logo for Geodesical, featuring the word "Geodesical" in a blue, sans-serif font. A light blue, stylized orbital ring or path surrounds the letter "G".

The logo for Geodesical, featuring the word "Geodesical" in a bold, blue, sans-serif font. A light blue, stylized orbital ring or path encircles the letter "G".

 **Geodesical**