

## **IMPORTANT NOTICE**

All rights to this manual are owned solely by SATEL OY (referred to in this user guide as SATEL). All rights reserved. The copying of this manual (without the written permission from the owner) by printing, copying, recording or by any other means, or the full or partial translation of the manual to any other language, including all programming languages, using any electrical, mechanical, magnetic, optical, manual or other methods or devices is forbidden.

SATEL reserves the right to change the technical specifications or functions of its products, or to discontinue the manufacture of any of its products or to discontinue the support of any of its products, without any written announcement and urges its customers to ensure, that the information at their disposal is valid.

SATEL software and programs are delivered "as is". The manufacturer does not grant any kind of warranty including guarantees on suitability and applicability to a certain application. Under no circumstances is the manufacturer or the developer of a program responsible for any possible damages caused by the use of a program. The names of the programs as well as all copyrights relating to the programs are the sole property of SATEL. Any transfer, licensing to a third party, leasing, renting, transportation, copying, editing, translating, modifying into another programming language or reverse engineering for any intent is forbidden without the written consent of SATEL.

**SATEL PRODUCTS HAVE NOT BEEN DESIGNED, INTENDED NOR INSPECTED TO BE USED IN ANY LIFE SUPPORT RELATED DEVICE OR SYSTEM RELATED FUNCTION NOR AS A PART OF ANY OTHER CRITICAL SYSTEM AND ARE GRANTED NO FUNCTIONAL WARRANTY IF THEY ARE USED IN ANY OF THE APPLICATIONS MENTIONED.**

Salon, FINLAND 2005

## RESTRICTIONS ON USE

SATELLINE-3AS(d) radio modems have been designed to operate on frequency ranges, the exact use of which differs from one region and/or country to another. The user of a radio modem must take care that the said device is not operated without the permission of the local authorities on frequencies other than those specifically reserved and intended for use without a specific permit.

**SATELLINE-3AS(d)** (380...470 MHz) is allowed to be used in the following countries, either on licence free channels or on channels where the operation requires a licence. More detailed information is available at the local frequency management authority.

Countries\*: AT, AU, BE, BR, BG, CA, HR, CZ, CY, DK, EE, FI, FR, DE, GR, HK, HU, IS, IE, IL, IT, LV, LT, MT, MY, NL, NO, PL, PT, RO, RU, SG, SI, ZA, ES, SE, CH, TR, UE, GB and US

**SATELLINE-3AS(d) 869 MHz** is designed to operate in the following countries listed below on the licence free frequency band of 869.400 – 869.650 MHz (not incorporating the band 869.300 – 869.400 MHz) according to recommendation CEPT/ERC/REC 70-03. This recommendation has been drawn up by the European Radiocommunications Committee (ERC) under CEPT. The transmit/receive duty cycle of the individual unit is limited to 10% on this band, and a single transmission period must not exceed 36 s. In addition, the maximum allowed radiated output power is 500 mW<sub>ERP</sub>.

Countries\*: AT, BE, CZ, DK, EE, FI, FR, DE, GR, HU, IS, IE, IT, LV\*<sup>1</sup>, MT, NL, NO, PL, PT, SK, ES, SE, CH and GB

\*<sup>1</sup> Max. ERP 10 mW

**SATELLINE-3AS(d) Epic** is allowed to be used in the following countries, either on licence free channels or on channels where the operation requires a licence. More detailed information is available at the local frequency management authority.

Countries\* for the version of 12.5 kHz channel spacing:

AT, AU, BE, CA, DK, FI, FR, DE, GR, IS, IE, IT, LT, LV, MY, MT, NL, NO, PL, PT, RU, ZA, ES, SE, CH, TR, UE, GB and US

Countries\* for the version of 25 kHz channel spacing:

AT, AU, CA, EE, FI, DE, GR, HU, IS, IE, LT, LV, MY, MT, NO, PL, RU, ES, CH, TR, UE and US

**WARNING!** Users of SATELLINE-3AS(d) and Epic radio modems in North America should be aware, that due to the allocation of the frequency band 406.0 – 406.1 MHz for government use only, the use of radio modem on this frequency band without a proper permit is strictly forbidden.

\* codes of the countries follow the ISO 3166-1-Alpha-2 standard

## PRODUCT CONFORMITY

### SATELLINE-3AS(d)

Hereby, SATEL Oy declares that SATELLINE-3AS(d) radio modem is in compliance with the essential requirements (radio performance, electromagnetic compatibility and electrical safety) and other relevant provisions of Directive 1999/5/EC. Therefore the equipment is labelled with the following CE-marking. The notification sign informs user that the operating frequency range of the device is not harmonised throughout the market area, and the local spectrum authority should be contacted before the usage of the radio modem.

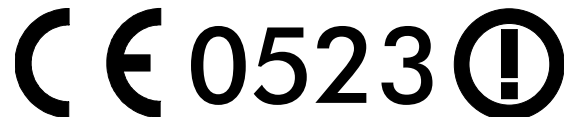



### DECLARATION of CONFORMITY

In Accordance with  
**1999/5/EC Directive**

of the European Parliament and of the Council of 9 March 1999 on radio equipment and telecommunications terminal equipment and the mutual recognition of their conformity

**Doc No:** SATEL-DC/RTTE/033

**Manufacturer:** SATEL Oy

**Address:** POB 142, ( Meriniitynkatu 17 )  
24101 Salo  
Finland

**Product:** SATELLINE-3AS/125 Radio Modem  
SATELLINE-3ASm/125/LC Radio Modem  
SATELLINE-3ASd/125 Radio Modem  
SATELLINE-3AS/250 Radio Modem  
SATELLINE-3ASm/250/LC Radio Modem  
SATELLINE-3ASd/250 Radio Modem

**Notified Body Opinion:** according to: Annex IV of R&TTE Directive  
Document Nr: F100700020 and F103700026  
Issued by: Finnish Communications Regulatory Authority  
Dated On: 2<sup>nd</sup> of July, 2002 and 9<sup>th</sup> of October, 2003  
Notified Body Nr. 0523

We, the manufacturer of the above mentioned products, hereby declare that these products conform to the essential requirements of the European Union directive 1999/5/EC. This Declaration of Conformity is based on the following documents:

Doc. No	Type of Product	Test Specification	Laboratory / Date of Issue
TL 990313	-3ASd/125	ETS 300 113	EMCEC / Espoo 29.02.2000
TL 1000461	-3ASd/250	ETS 300 113	EMCEC / Espoo 29.02.2000
TL 980212	-3ASd/250	EN 300 220-1	EMCEC / Espoo 07.10.1998
200212216	-3ASd/125	IEC 60950 3 <sup>rd</sup> Ed 1999	NEMKO / Oslo 22.03.2002
200212216	-3ASd/250	IEC 60950 3 <sup>rd</sup> Ed 1999	NEMKO / Oslo 22.03.2002
1031840	-3ASm/125	EN 300 220-1	NEMKO / Espoo 26.09.2003
1031925	-3ASd/250	EN 301 489-1,-5	NEMKO / Espoo 30.10.2003

Salo on the 22<sup>nd</sup> of January, 2004.

SATEL OY  
*Pekka Aara*  
Pekka Aara



**Doc No:** SATEL-DC/RTTE/033

**Manufacturer:** SATEL Oy

**Address:** POB 142, ( Meriniitynkatu 17 )  
24101 Salo  
Finland

### SATELLINE-3AS(d) Epic

Hereby, SATEL Oy declares that SATELLINE-3AS(d) Epic radio modem is in compliance with the essential requirements (radio performance, electromagnetic compatibility and electrical safety) and other relevant provisions of Directive 1999/5/EC. Therefore the equipment is labelled with the following CE-marking. The notification sign informs user that the operating frequency range of the device is not harmonised throughout the market area, and the local spectrum authority should be contacted before the usage of the radio modem.

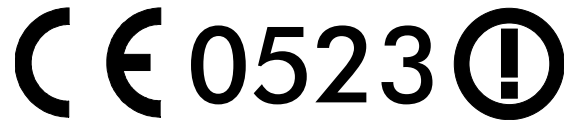

 **SATEL**

**DECLARATION of CONFORMITY**

In Accordance with  
**1999/5/EC Directive**

of the European Parliament and of the Council of 9 March 1999 on radio equipment and telecommunications terminal equipment and the mutual recognition of their conformity

Doc No: SATEL-DC-RTTE-019

Manufacturer: SATEL Oy

Address: POB 142, ( Meriniitynkatu 17 )  
24101 Salo  
Finland

Product: **SATELLINE-3AS/250/10W/DIV Radio Modem**  
**SATELLINE-3ASd/250/10W/DIV Radio Modem**

Brand name **SATELLINE-3AS Epic**

Notified Body Opinion: according to: Annex IV of R&TTE Directive  
Document Nr: FI02700011  
Issued by: Finnish Communications Regulatory Authority  
Dated On: 8<sup>th</sup> of April, 2002  
Notified Body: Nr. 0523

We, the manufacturer of the above mentioned products, hereby declare that these products conform to the essential requirements of the European Union directive 1999/5/EC. This Declaration of Conformity is based on the following documents:

Doc. No	Type of Product	Test Specification	Date of Issue
TL 1010749	SATELLINE-3ASd/125/10W/DIV	EN 300 113-1	27.2.2001
TL 1010876	SATELLINE-3ASd/250/10W/DIV	EN 300 113-1	27.8.2001
TL 1010750	SATELLINE-3ASd/125/10W/DIV	ETS 300 279	28.02.2001
TEST LABORATORY EMCEC Oy, Espoo, Finland			
200212274	SATELLINE-3ASd/125/10W/DIV	IEC 60950	22.3.2002
200212274	SATELLINE-3ASd/250/10W/DIV	IEC 60950	22.3.2002
TEST LABORATORY NEMKO / Oslo, Norway			

Salo on the 18th of April, 2002.

SATEL OY  
  
Pekka Ayra  
Managing Director



Satel Oy, PO.Box 142, FIN-24101 Salo, Finland  
Street: Meriniitynkatu 17, FIN-24100 Salo, Finland  
Tel +358 2 777 7800, Fax +358 2 777 7810, E-mail info@satel.fi  
www.satel.fi



LOCAL AREA WIRELESS DATA COMMUNICATIONS

## DECLARATION of CONFORMITY

In Accordance with  
**1999/5/EC Directive**

of the European Parliament and of the Council of 9 March 1999 on radio equipment and telecommunications terminal equipment and the mutual recognition of their conformity

Doc No: SATEL-DC-RTTE-018

Manufacturer: SATEL Oy

Address: POB 142, ( Meriniitynkatu 17 )  
24101 Salo  
Finland

Product: **SATELLINE-3AS/125/10W/DIV** Radio Modem  
**SATELLINE-3ASd/125/10W/DIV** Radio Modem

Brand name SATELLINE-3AS Epic

Notified Body Opinion: according to: Annex IV of R&TTE Directive  
Document Nr: FIO1700053  
Issued by: Finnish Communications Regulatory Authority  
Dated On: 9<sup>th</sup> of April, 2002  
Notified Body Nr. 0523

We, the manufacturer of the above mentioned products, hereby declare that these products conform to the essential requirements of the European Union directive 1999/5/EC. This Declaration of Conformity is based on the following documents:

Doc. No	Type of Product	Test Specification	Date of Issue
TL 1010749	SATELLINE-3ASd/125/10W/DIV	EN 300 113-1	27.2.2001
TL 1010750	SATELLINE-3ASd/125/10W/DIV	ETS 300 279	28.02.2001
TEST LABORATORY	EMCEC Oy, Espoo, Finland		
200212274	SATELLINE-3ASd/125/10W/DIV	IEC 60950	22.3.2002
200212274	SATELLINE-3ASd/250/10W/DIV	IEC 60950	22.3.2002
TEST LABORATORY	NEMKO / Oslo, Norway		

Salo on the 18th of April, 2002.

SATEL OY  
  
Pekka Aara  
Managing Director



Satel Oy, P.O.Box 142, FIN-24101 Salo, Finland  
Street: Meriniitynkatu 17, FIN-24100 Salo, Finland  
Tel +358 2 777 7800, Fax +358 2 777 7810, E-mail info@satel.fi  
www.satel.fi



### SATELLINE-3AS(d) 869

Hereby, SATEL Oy declares that SATELLINE-3AS(d) radio modem is in compliance with the essential requirements (radio performance, electromagnetic compatibility and electrical safety) and other relevant provisions of Directive 1999/5/EC. Therefore the equipment is labelled with the following CE-marking.

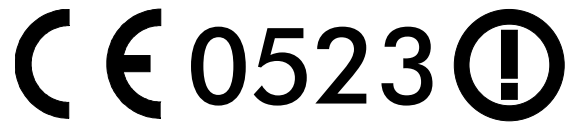

## DECLARATION of CONFORMITY

In Accordance with  
**1999/5/EC Directive**

of the European Parliament and of the Council of 9 March 1999 on radio equipment and telecommunications terminal equipment and the mutual recognition of their conformity

Doc No: SATEL-DC-RTTE-0017

Manufacturer: SATEL Oy

Address: POB 142, (Meriniitynkatu 17)  
24101 Salo  
Finland

Product: SATELLINE-3ASd/869 Radio Modem  
SATELLINE-3AS/869 Radio Modem

Notified Body Opinion: according to: Annex IV of R&TTE Directive  
Document Nr: FI01700018  
Issued by: Finnish Communications Regulatory Authority  
Dated On: 9<sup>th</sup> of April 2002  
Notified Body Nr. 0523

We, the manufacturer of the above mentioned products, hereby declare that these products conform to the essential requirements of the European Union directive 1999/5/EC. This Declaration of Conformity is based on the following documents:

Doc. No	Type of Product	Test Specification	Laboratory / Date of Issue
TL 1000553	-3ASd/869	EN 300 220-1	EMCEC / Espoo 23.08.2000
TL 1000603	-3AS(d)/869	ETS 300 683	EMCEC / Espoo 30.08.2000
200212216	-3AS(d)/869	IEC 60950 3 <sup>rd</sup> Ed 1999	NEMKO / Oslo 22.03.2002

Salo on the 18<sup>th</sup> of April, 2002.

SATEL OY  
  
Pekka Aura  
Managing Director



Satel Oy, PO Box 142, FIN-24101 Salo, Finland  
Street: Meriniitynkatu 17, FIN-24100 Salo, Finland  
Tel +358 2 777 7800, Fax +358 2 777 7810, E-mail info@satel.fi  
www.satel.fi

## **WARRANTY AND SAFETY INSTRUCTIONS**

Read these safety instructions carefully before using the product:

- Warranty will be void, if the product is used in any way that is in contradiction with the instructions given in this manual, or if the radio modem housing has been opened or tampered with.
- The radio modem is only to be operated at frequencies allocated by local authorities, and without exceeding the given maximum allowed output power ratings. SATEL and its distributors are not responsible, if any products manufactured by it are used in unlawful ways.
- The devices mentioned in this manual are to be used only according to the instructions described in this manual. Faultless and safe operation of the devices can be guaranteed only if the transport, storage, operation and handling of the devices is appropriate. This also applies to the maintenance of the products.
- To prevent damage both the radio modem and any terminal devices must always be switched OFF before connecting or disconnecting the serial connection cable. It should be ascertained that different devices used have the same ground potential. Before connecting any power cables the output voltage of the power supply should be checked.

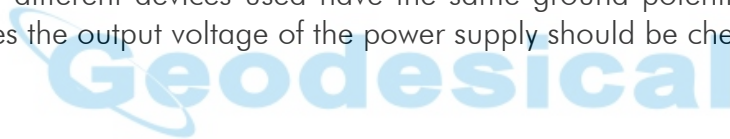
The logo for Geodesical, featuring the word "Geodesical" in a light blue, sans-serif font. A stylized blue line graphic resembling a globe or a path curves around the letters "G" and "e".

## TABLE OF CONTENTS

<b>IMPORTANT NOTICE .....</b>	<b>1</b>
<b>RESTRICTIONS ON USE .....</b>	<b>2</b>
<b>PRODUCT CONFORMITY.....</b>	<b>3</b>
<b>WARRANTY AND SAFETY INSTRUCTIONS .....</b>	<b>7</b>
<b>TABLE OF CONTENTS .....</b>	<b>8</b>
<b>INTRODUCTION .....</b>	<b>13</b>
<b>1 SATELLINE-3AS(D)/869 MHZ/EPIC RADIO DATA MODEMS.....</b>	<b>14</b>
1.1 SATELLINE-3AS(d) Technical specifications (380...470 MHz).....	14
1.2 SATELLINE-3AS(d) Technical specifications (869 MHz).....	15
1.3 SATELLINE-3AS(d) Epic Technical specifications (400...470 MHz) .....	16
1.4 SATELLINE-3AS 7V2 Technical specifications (380...470 MHz).....	17
1.5 Basic configuration and installation.....	18
1.5.1 Prepare installation of SATELLINE-3AS(d) modem into the SATEL-321 casing .....	20
<b>2 SERIAL INTERFACE .....</b>	<b>21</b>
2.1 D15 connector .....	22
2.2 RS-232 interface.....	23
2.3 RS-422 interface.....	24
2.4 RS-485 interface.....	25
2.5 Termination of RS-422/485 lines .....	25
<b>3 RF INTERFACE .....</b>	<b>26</b>
3.1 Transmitter.....	26
3.2 Receiver.....	27
3.2.1 RSSI-signal.....	28



<b>3.3</b>	<b>Priority RX/TX</b> .....	<b>29</b>
<b>3.4</b>	<b>Error correction</b> .....	<b>29</b>
<b>3.5</b>	<b>Error checking</b> .....	<b>30</b>
<b>3.6</b>	<b>Dual Band version</b> .....	<b>30</b>
<b>3.7</b>	<b>Dual Channel function</b> .....	<b>30</b>
<b>3.8</b>	<b>Free Channel Scan (FCS) function</b> .....	<b>32</b>
<b>4</b>	<b>USER INTERFACE</b> .....	<b>33</b>
<b>4.1</b>	<b>LED-indicators</b> .....	<b>33</b>
<b>4.2</b>	<b>Programming Mode</b> .....	<b>33</b>
4.2.1	Changing the settings .....	34
4.2.2	Restoring factory settings .....	35
<b>4.3</b>	<b>Display and push buttons (SATELLINE-3ASd (Epic))</b> .....	<b>35</b>
<b>5</b>	<b>TRANSPARENT DATA TRANSMISSION</b> .....	<b>37</b>
<b>5.1</b>	<b>Serial interface, data format</b> .....	<b>37</b>
<b>5.2</b>	<b>Handshake lines</b> .....	<b>38</b>
5.2.1	CTS-line .....	38
5.2.2	CD-line .....	38
5.2.3	RTS-line.....	39
<b>5.3</b>	<b>Timing and delays during data transmission</b> .....	<b>39</b>
5.3.1	Data buffering in the radio data modem .....	39
5.3.2	Optional start delay in transmit mode.....	40
<b>5.4</b>	<b>Tests</b> .....	<b>40</b>
<b>6</b>	<b>REPEATER MODE AND ADDRESSING</b> .....	<b>42</b>
<b>6.1</b>	<b>Repeater</b> .....	<b>42</b>
<b>6.2</b>	<b>Addressing</b> .....	<b>43</b>
6.2.1	Connection between two points .....	45
6.2.2	System of one base station and several substations .....	45
<b>6.3</b>	<b>Using repeaters and addresses in the same system</b> .....	<b>46</b>
6.3.1	System with several repeaters.....	46
6.3.2	Repeater chain using address pairs .....	47
6.3.3	Repeater chain using dual addressing.....	48
6.3.4	Redundant repeater chain .....	48

<b>7</b>	<b>MESSAGE ROUTING .....</b>	<b>49</b>
<b>7.1</b>	<b>Introduction to Message Routing.....</b>	<b>49</b>
7.1.1	Features of Message Routing .....	50
7.1.2	Limitations of Message Routing .....	50
7.1.3	Getting started with Message Routing .....	50
7.1.4	Saterm and the configuration of the Message Routing .....	51
7.1.5	Manual configuration of the Message Routing.....	51
7.1.6	Configuration of the protocol in Message Routing .....	52
<b>7.2</b>	<b>Operating modes of Message Routing .....</b>	<b>53</b>
<b>7.3</b>	<b>Detailed description of Message Routing.....</b>	<b>54</b>
7.3.1	Source Mode Routing .....	54
7.3.2	Virtual Mode Routing .....	54
7.3.3	Overhop function in Source Mode Routing .....	55
7.3.4	Special protocols.....	56
7.3.5	Network ID .....	56
<b>8</b>	<b>DIVERSITY RECEIVER (SATELLINE-3AS EPIC ONLY).....</b>	<b>57</b>
<b>8.1</b>	<b>Multipath fading .....</b>	<b>57</b>
<b>8.2</b>	<b>Antenna installation .....</b>	<b>58</b>
<b>9</b>	<b>SETTINGS.....</b>	<b>59</b>
<b>9.1</b>	<b>Changing parameters using a terminal device.....</b>	<b>59</b>
9.1.1	Changing frequency (active radio channel frequency).....	60
9.1.2	Changing radio settings (transmitter output power and receiver sensitivity).....	61
9.1.3	Changing addressing settings (primary and secondary RX- and TX-addresses).....	63
9.1.4	Changing serial port settings (Port 1 and Port 2) .....	65
9.1.5	Modification of handshaking functions.....	68
9.1.6	Special functions .....	70
9.1.7	Modification of routing.....	71
9.1.8	Activating tests .....	75
9.1.9	Restoring factory settings .....	75
9.1.10	Saving modified settings into the permanent memory .....	75
9.1.11	Updating software .....	75
<b>9.2</b>	<b>Changing parameters using the LCD-display .....</b>	<b>76</b>
9.2.1	Changing frequency (frequency of the active radio channel) .....	77
9.2.2	Changing radio settings (transmitter power and receiver sensitivity).....	79
9.2.3	Changing addressing .....	80
9.2.4	Changing serial port settings (Port 1 and Port 2) .....	81
9.2.5	Modification of handshaking functions.....	82
9.2.6	Selecting special functions .....	83
9.2.7	Activating tests .....	83
9.2.8	Restoring factory settings .....	84

9.2.9	Adjusting the contrast of the LCD-display .....	84
9.2.10	Saving modified values into the internal memory .....	85
<b>9.3</b>	<b>Changing parameters using the SL-COMMANDS .....</b>	<b>85</b>
9.3.1	Frequency .....	86
9.3.2	Addressing .....	86
9.3.3	Radio parameters .....	87
9.3.4	Other functions .....	87
9.3.5	SATELLINE-2ASxE compatible SL-commands .....	88
<b>10</b>	<b>INSTALLATION .....</b>	<b>89</b>
<b>10.1</b>	<b>Installation of a Radio Data Modem .....</b>	<b>89</b>
<b>10.2</b>	<b>Connection cables .....</b>	<b>90</b>
10.2.1	RS-232 wiring .....	90
10.2.2	RS-422 wiring .....	92
10.2.3	RS-485 wiring .....	93
10.2.4	Fuse .....	94
10.2.5	Power supply .....	94
<b>10.3</b>	<b>Antenna installation .....</b>	<b>95</b>
10.3.1	Hand-held equipment .....	95
10.3.2	Mobile equipment .....	95
10.3.3	Base stations .....	95
10.3.4	General antenna installation instructions .....	96
<b>11</b>	<b>DESIGNING SYSTEMS .....</b>	<b>99</b>
<b>11.1</b>	<b>Factors affecting the quality and distance of the radio connection .....</b>	<b>99</b>
<b>11.2</b>	<b>Radio field strength .....</b>	<b>100</b>
<b>11.3</b>	<b>Remarks concerning the 869 MHz frequency band .....</b>	<b>100</b>
<b>12</b>	<b>CHECK LIST .....</b>	<b>101</b>
<b>13</b>	<b>ACCESSORIES .....</b>	<b>102</b>
<b>13.1</b>	<b>RS-232 cables and adapters .....</b>	<b>102</b>
<b>13.2</b>	<b>RS-485/422 cables and adapters .....</b>	<b>102</b>
<b>13.3</b>	<b>RF-cables .....</b>	<b>102</b>
<b>13.4</b>	<b>Antennas .....</b>	<b>102</b>
<b>13.5</b>	<b>Filters and lightning protectors .....</b>	<b>103</b>

<b>13.6</b>	<b>Power supplies .....</b>	<b>103</b>
<b>13.7</b>	<b>Batteries .....</b>	<b>103</b>
<b>13.8</b>	<b>Installation and enclosures .....</b>	<b>103</b>
<b>14</b>	<b>APPENDIX A .....</b>	<b>104</b>
<b>15</b>	<b>APPENDIX B .....</b>	<b>105</b>
<b>15.1</b>	<b>Functional delays .....</b>	<b>105</b>
<b>15.2</b>	<b>Transmission related delays .....</b>	<b>105</b>
15.2.1	Transmission delays when using a 12.5 kHz radio channel .....	106
15.2.2	Transmission delays using a 25 kHz radio channel .....	108







# 1 SATELLINE-3AS(d)/869 MHz/Epic RADIO DATA MODEMS

## 1.1 SATELLINE-3AS(d) Technical specifications (380...470 MHz)

SATELLINE-3AS(d) (380...470 MHz) comply with the following international standards: ETS 300 113 and EN 300 220-1 (radio requirements) and ETS 300 279 and ETS 300 683 (EMC-requirements).

### RADIO TRANSCEIVER

Frequency Range	380...470 MHz
Channel Spacing	12.5 kHz/25 kHz
Number of Channels	160 / 80 or (2 x 160 / 2 x 80) *Note 1
Frequency Stability	< ± 1.5 kHz
Type of Emission	F1D
Communication Mode	Half-Duplex

### RADIO TRANSMITTER

Carrier Power	10 mW...1 W / 50 Ω
Carrier Power Stability	+ 2 dB / - 3 dB
Adjacent Channel Power	according to EN 300 220-1/ETS 300 113
Spurious Radiation	according to EN 300 220-1/ETS 300 113

### RADIO RECEIVER

Sensitivity	- 116... -110 dBm (BER < 10 E-3) *Note 2
Common Channel Rejection	> - 12 dB
Adjacent Channel Selectivity	> 60 dB @ 12,5 kHz, > 70 dB @ 25 kHz
Intermodulation Attenuation	> 65 dB
Spurious Radiation	< 2 nW

### MODEM

Interface	RS-232 or RS-485, RS-422
Interface Connector	D15, female
Data Speed of Serial Interface	300 – 38400 bps
Data Speed of Radio Interface	19200 bps (25 kHz channel) 9600 bps (12.5 kHz channel)
Data format	Asynchronous RS-232 or RS-422 or RS-485

### GENERAL

Operating Voltage	+ 9 ... + 30 V <sub>DC</sub>
Power Consumption (average)	1.7 VA (Receive) 5.5 VA (Transmit) 0.05 VA (in Standby Mode)
Operating Temperature Range	-25 °C...+55 °C
Antenna Connector	TNC, 50 Ω, female
Housing	Aluminium enclosure
Size H x W x D	137 x 67 x 29 mm
Installation Plate	130 x 63 x 1 mm
Weight	250 g

\* Note 1: The Dual Band version operates on two separate 2 MHz wide frequency bands.

\* Note 2: Depending on Receiver settings, see Chapters 3.2, 9.1.2 and 9.2.2.

## **1.2 SATELLINE-3AS(d) Technical specifications (869 MHz)**

SATELLINE-3AS(d) (869 MHz) comply with the following international standards: EN 300 220-1 (radio requirements) and ETS 300 683 (EMC-requirements).

### **RADIO TRANSCEIVER**

Frequency Range	869.400 ... 869.650 MHz
Channel Spacing	25 kHz
Number of Channels	10
Frequency Stability	< ± 2.5 kHz
Type of Emission	F1D
Communication Mode	Half-Duplex

### **RADIO TRANSMITTER**

Carrier Power	10 mW...500 mW / 50 Ω
Carrier Power Stability	+ 2 dB / - 3 dB
Adjacent Channel Power	according to EN 300 220-1
Spurious Radiation	according to EN 300 220-1

### **RADIO RECEIVER**

Sensitivity	-108 dBm (BER < 10 E-3) *
Common Channel Rejection	> - 12 dB
Adjacent Channel Selectivity	> 60 dB
Intermodulation Attenuation	> 60 dB
Spurious Radiation	< 2 nW

### **MODEM**

Interface	RS-232 or RS-485, RS-422
Interface Connector	D15, female
Data speed of RS-Interface	300 – 38400 bps
Data speed of Radio Interface	19200 bps (25 kHz channel)
Data format	Asynchronous RS-232 or RS-422 or RS-485

### **GENERAL**

Operating Voltage	+ 9 ... + 30 V <sub>DC</sub>
Power Consumption (average)	1.7 VA (Receive) 4.0 VA (Transmit) 0.05 VA (in <i>Standby Mode</i> )
Operating Temperature Range	-25 °C...+55 °C
Antenna Connector	TNC, 50 Ω, female
Housing	Aluminium enclosure
Size H x W x D	137 x 67 x 29 mm
Installation Plate	130 x 63 x 1 mm
Weight	250 g

\* Depending on Receiver settings, see Chapters 3.2, 9.1.2 and 9.2.2.

### **1.3 SATELLINE-3AS(d) Epic Technical specifications (400...470 MHz)**

SATELLINE-3AS(d) Epic (400...470 MHz) complies with the following international standards: ETS 300 113 (radio requirements) and ETS 300 279 (EMC-requirements).

#### **RADIO TRANSCEIVER**

Frequency Range	400...470 MHz
Channel Spacing	12.5 kHz/25 kHz
Number of Channels	160 / 80
Frequency Stability	$< \pm 1.5$ kHz
Type of Emission	F1D
Communication Mode	Half-Duplex

#### **RADIO TRANSMITTER**

Carrier Power	1W...10 W / 50 $\Omega$
Carrier Power Stability	+ 2 dB / - 3 dB
Adjacent Channel Power	according to ETS 300 113
Spurious Radiation	according to ETS 300 113

#### **RADIO RECEIVER**

Sensitivity	- 116... -110 dBm (BER < 10 E-3) *
Common Channel Rejection	> - 12 dB
Adjacent Channel Selectivity	> 60 dB @ 12.5 kHz, > 70 dB @ 25 kHz
Intermodulation Attenuation	> 65 dB
Spurious Radiation	< 2 nW
Diversity	Positional diversity

#### **MODEM**

Interface	RS-232 or RS-485, RS-422
Interface Connector	D15, female
Data Speed of Serial Interface	300 – 38400 bps
Data Speed of Radio Interface	19200 bps (25 kHz channel) 9600 bps (12.5 kHz channel)
Data format	Asynchronous RS-232 or RS-422 or RS-485

#### **GENERAL**

Operating Voltage	+11.8...+30 V <sub>DC</sub>
Power Consumption (average)	3 VA (Receive) 25 VA (Transmit) 0.1 VA (in <i>Standby Mode</i> )
Operating Temperature Range	-25 °C...+55 °C
Antenna Connector	TNC, 50 $\Omega$ , female
Housing	Aluminium enclosure
Size H x W x D	151 x 123 x 29 mm
Weight	550 g (without additional cooling parts)

- Depending on Receiver settings, see Chapters 3.2, 9.1.2 and 9.2.2.

## 1.4 **SATELLINE-3AS 7V2 Technical specifications (380...470 MHz)**

SATELLINE-3AS 7V2 is a special model of SATELLINE-3AS that has a lower supply voltage range than the ordinary SATELLINE-3AS. All the other features and the operation are the same.

Operating Voltage	+6.5...+8.5 V <sub>DC</sub>
Current Consumption (average)	160 mA (Receive) 700 mA (Transmit) 0.8 mA (in <i>Standby Mode</i> )

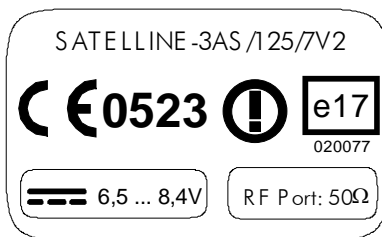

SATELLINE-3AS 7V2 can be distinguished from the standard model by checking the "7V2" text on the CE label, see the example on the left.



## 1.5 Basic configuration and installation

The radio modem is shipped with the following default settings (unless otherwise specifically ordered):

FIXED SETTINGS DEFINED AT THE TIME OF ORDER	
Radio Frequency Range	In accordance with Customer Order and taking into account the regulations set by the local authorities, between 380–470 MHz, 400–470 MHz (Epic) or 869.5 MHz
Channel Spacing	12.5 kHz or 25 kHz apart from the 869 MHz which must be 25 kHz
Serial Interface Type	RS-232 or RS-422 and RS-485

ADJUSTABLE SETTINGS	
Radio Settings	500 mW / -112 dBm (25 kHz) or -114 dBm (12.5 kHz) apart from the Epic which ranges from 1W to 10W Diversity mode OFF (applies to Epic)
Addressing	RX Address OFF / TX Address OFF
Serial Port 1	ON / 19200 / 8 bit data / None / 1 stop bit for 12.5 kHz the default data speed is 9600 bps
Serial Port 2	OFF / 19200 / 8 bit data / None / 1 stop bit for 12.5 kHz the default data speed is 9600 bps
Handshaking	CTS Clear to send / CD RSSI-threshold / RTS Ignored
Additional settings	Error Correction OFF / Error check OFF / Repeater OFF / SL-Commands OFF / Priority TX
Routing	OFF
Tests	OFF
Message Routing	OFF

The power cable (+V<sub>b</sub> and GND) must be connected to a power supply with a proper output voltage and with a minimum output current of 1 A (with the SATELLINE-3AS Epic the required output current of the power supply is 5A). The DTR-pin of the serial line connector must also be connected to a positive voltage. Detailed installation instructions can be found in Chapter 10.

If the DTR-pin is not connected, the radio modem will remain in STAND-BY mode and will therefore not send or receive any data.

When creating a test connection, you can either use the *SaTerm* terminal program, (available for free from authorised SATEL dealers or directly from SATEL Customer Support) or *HyperTerminal* (which is included in most the Windows™ based operating system packages), or almost any other terminal program. Basic settings for the serial port of the host computer, when using a terminal program to communicate with SATEL radio modems, are as follows: "COM1, 19200 bps, 8-bit data, none parity, 1 stop bit". If the serial port designated as COM1 in the host computer is reserved, any other free serial port in the host computer can be used (with the settings listed).

Note: If you want to change the settings of a radio modem using the *Programming Mode* of the radio modem with the help of an external terminal, the data speed of the terminal must be 9600 bps.



Basic connection between a radio modem and the serial port COM1 (RS-232) of a PC is depicted in the schematic below.

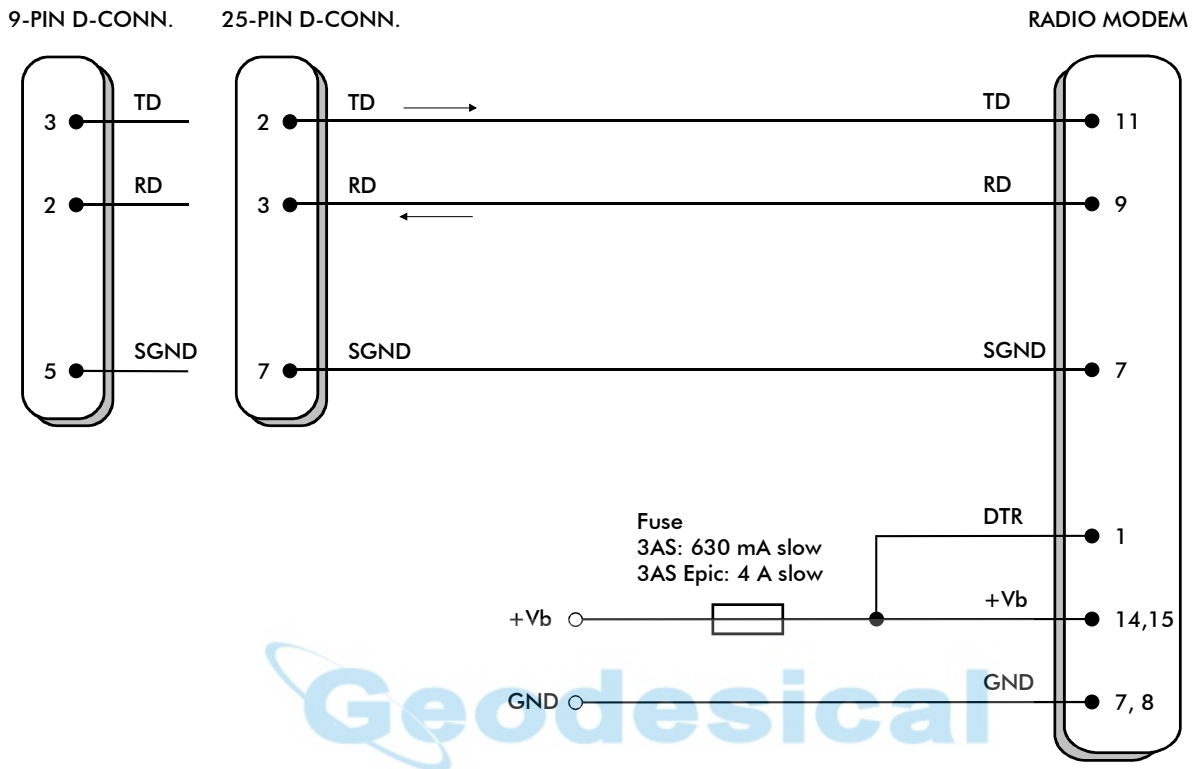

**NOTE THE WIRING ON THE DIAGRAM ABOVE!** The maximum voltage level at DTR pin is +25 Vdc. In case the operating voltage is greater, user must take care that the voltage at DTR pin does not exceed +25 Vdc e.g. by using a resistive divider.

When using the SATELLINE-3AS, the operating voltage can be connected to either pin 14 or 15, and the power supply ground to either pin 7 or 8. Fuse size is 630 mA (slow).

When using the SATELLINE-3AS Epic model, the operating voltage must be connected to pins 14 AND 15, and the power supply ground to pins 7 AND 8, due to a larger current consumption. Fuse size is 4A (slow).

### **1.5.1 Prepare installation of SATELLINE-3AS(d) modem into the SATEL-321 casing**

Before installing a SATELLINE-3AS(d) or 3AS(d) 869 modem into the SATEL-321 casing, the battery pack function must be selected as follows:

1. Switch the radio modem into the Programming Mode, see chapter 4.2 Programming Mode.
2. Select main menu selection "5" (Serial Port 2).
3. Enter selection "1" (Port Status).
4. Select "3" (BATT / LCD) for 3ASd or 3ASd 869 modems. Select "4" (BATT / NO LCD) for 3AS or 3AS 869 modems.
5. Save the setting.
6. Switch the radio modem back into Data Transfer Mode.

Please notice that both serial ports must be RS-232, NOT RS-485 / 422 and the SW –version of the 3AS(d) modem must be V2.16 or later.

Please check the installation advice from the SATEL-321 user guide, Chapter 4.2 *Installing a radio modem into the SATEL-321 casing*



## 2 SERIAL INTERFACE

The radio modem is referred to as DCE (Data Communication Equipment) whereas the PC is referred to as DTE (Data Terminal Equipment). SATELLINE-3AS radio modem includes a 15-pin 'D'-type female connector, which contains all the connections required to establish communication between the radio modem, acting as the DCE, and the PC, acting as the DTE.

All EMC-requirements set forth by authorities have been taken into account in the design of the radio modem. The radio modem user is thereby not required to take any special actions regarding EMC-shielding (of the radio modem).

The radio modem contains two separate serial ports, which are designated **Port 1** and **Port 2**. Only one port at a time can be used for communication.

**Port 1** complies always with the RS-232 standard.

**Port 2** can comply either with the RS-232, RS-422 or RS-485 standards. The interface type is set at the factory according to the customer order. The interface type can be changed afterwards in the programming mode by the user.

### NOTE!

WHEN THE MODE-PIN (PIN 12 OF THE D-CONNECTOR) IS CONNECTED TO GROUND, THE RADIO MODEM IS IN THE PROGRAMMING MODE AND **Port 1** (PINS 7, 9, 11) IS THEN IN USE! If you normally use **Port 2** for data transmission, the serial cable must be changed to a suitable type when switching over to the configuration mode.

## 2.1 D15 connector

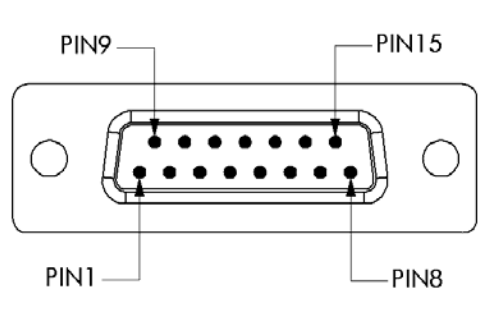

D-15 female connector in the radio modem

Direction **IN** is from DTE (Data Terminal Equipment) to the radio modem.

Direction **OUT** is from the radio modem to the DTE.

PORT AND TYPE	PIN	DIRECTION	NAME	EXPLANATION
PORT1, both models	6	OUT	CTS	*
	9	OUT	RD1	Receive data (Port1)
	11	IN	TD1	Transmit data (Port1)
	13	IN	RTS	*
PORT2 RS-232 model	2	OUT	CD	
	3	OUT	RD2	Receive data (Port2)
	4	IN	TD2	Transmit data (Port2)
	5	OUT	RSSI	Analog RSSI (Optional HW)
PORT2 RS-422 model	2	OUT	A'	Receive data positive
	3	OUT	B'	Receive data negative
	4	IN	A	Transmit data positive
	5	IN	B	Transmit data negative
PORT2 RS-485 model	2	IN / OUT	A	Data positive **)
	3	IN / OUT	B	Data negative **)
COMMON PINS	1	IN	DTR	ON ( $V_b$ ) / STANDBY (NC)
	10	OUT	DSR	
	12	IN	MODE	DATA (NC) / SETUP (GND)
	7, 8	-	GND	Power Ground
	14, 15	-	$V_b$	Operating Voltage

**NOTE!** Unused pins can be left unconnected.

\*) RTS and CTS handshaking connections remain the same irrespective of the port used (Port 1 or Port 2).

\*\*\*) A and B designators are opposite in Profibus standard.

### **Description of pins:**

- *RD* = **Receive Data**. Output of the data received from the radio modem to the DTE.
- *TD* = **Transmit Data**. Input of the data to be transmitted from the DTE to the radio modem.
- *CTS* = **Clear To Send**. See Chapter 5.2.1.
- *CD* = **Carrier Detect**. See Chapter 5.2.2.
- *RTS* = **Request To Send**. See Chapter 5.2.3
- *DTR* = **Data Terminal Ready**. Terminal in operation. When the DTR-line is connected to a positive voltage (e.g. to the operating voltage,  $V_b$ ), the radio modem is ON, if not, the radio modem is in the *Standby Mode*.
- *DSR* = **Data Set Ready**. Indicates that the radio modem is switched ON.
- *RSSI* = **Received Signal Strength Indicator**. Indicates the strength of the received signal. Can be used to approximately determine the received signal strength. Analog RSSI is a hardware option; it must be specified in the order. See Chapter 3.2.1.
- *MODE* = operational mode. When the MODE-line is connected to ground (GND), the radio modem enters the *Programming Mode* which is used to change the settings of the radio modem (i.e. configuration, set-up). If the MODE-line is not connected, the radio modem will enter the *Data Transfer Mode*, in which data can be transmitted and received. The *Programming Mode* is used only when installing a radio modem and changing the operational parameters of a network. Normally the radio modem is always in the *Data Transfer Mode*. See Chapter 4.2.
- *GND* = both the negative pole of the operating voltage and the signal ground.
- $V_b$  = positive pole of the operating voltage.

## **2.2 RS-232 interface**

RS-232 standard defines the method of serial data transfer between a computer and its peripherals. The definition includes both the interface type and signal levels. Most computers and peripherals contain one or more RS-232 type serial ports. The RS-232 standard uses transmission lines, in which each single signal line level is referenced, to a common ground level. RS-232 has been designed to be used in serial transfer of data, in situations where the distance between communicating equipment is less than 15 m. The otherwise useful RS-232 standard is applied in a multitude of slightly differing ways, (e.g. different pin configurations) and for this reason different computers and peripherals are not necessarily directly compatible with each other (see also Chapter 10.2.1 for more information on RS-232 wiring).



## 2.3 RS-422 interface

RS-422 standard defines a serial data transfer method, which is very similar to the RS-232 standard. In RS-422 however, the signal lines are balanced (or differential) transmission lines. A balanced (or differential) transmission line is formed by using two signal wires together to convey each single signal. Because the state of the signal is defined by the mutual voltage difference (hence the name differential), any common mode disturbances induced into the lines will cancel out. The effect of different signals moving in the same cable will also be smaller than in the case of the RS-232. Transmission distance can be considerably longer than when using RS-232 type of connection, and distances of 1 km are possible. (See also Chapter 10.2.2 for more information on RS-422 wiring).

As an example, let's examine the TX-signal: TX-signal will be transmitted using two lines (A and B). A logical "1" corresponds to a situation, where the voltage on line A is greater than the voltage on line B. Correspondingly a logical "0" corresponds to a situation, where the voltage on line A is smaller than the voltage on line B.

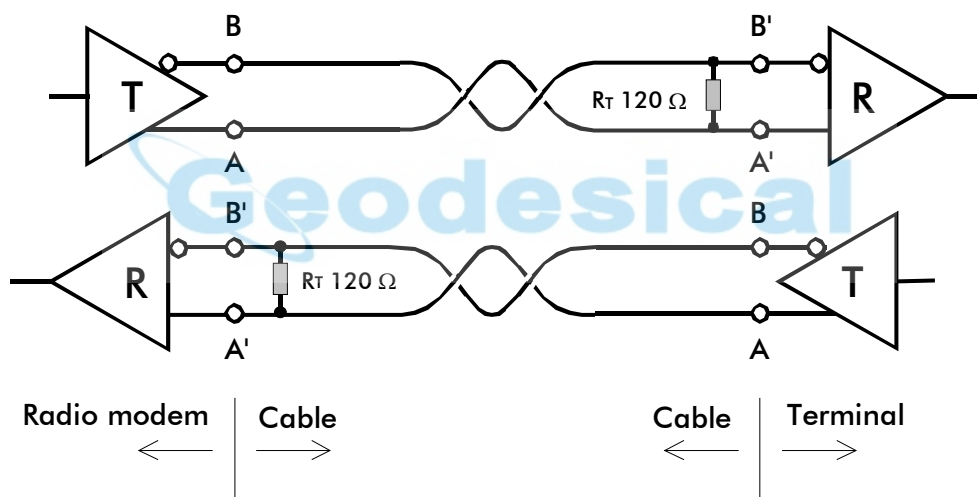

## 2.4 RS-485 interface

RS-485 is an extension of the RS-422 standard and enables the connection of more than two devices on to the same bus. Communication is half-duplex, so there is only one cable pair, compared to two when using the RS-422. The RS-485 standard defines the electrical characteristics of the connections in such a way as to prevent possible data contention states as well as cable shorts etc. from harming the devices themselves. (See also Chapter 10.2.3 for more information on RS-485 wiring).

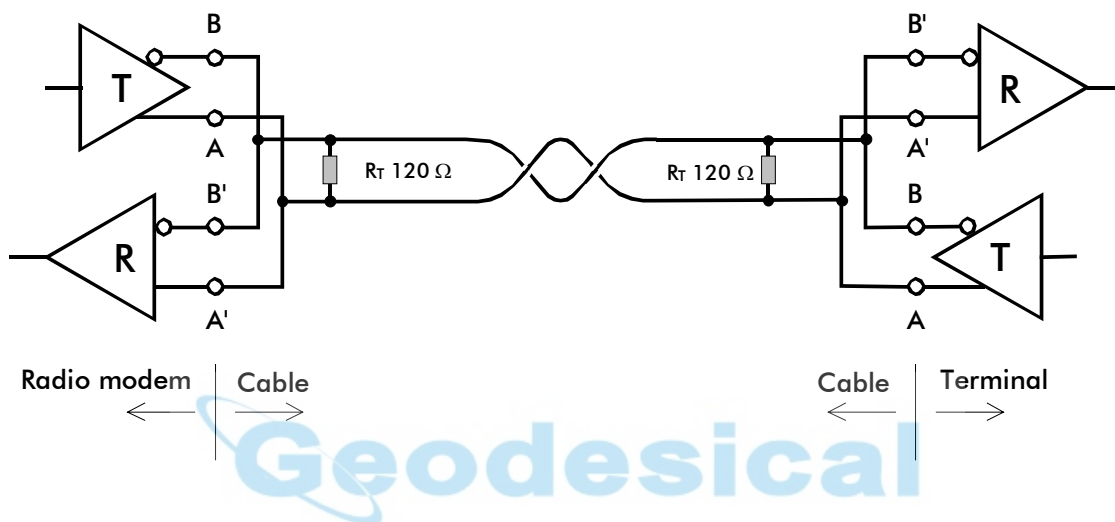

## 2.5 Termination of RS-422/485 lines

Each differential pair of wires is a transmission line. A transmission line must be terminated properly to prevent, or at least minimise, harmful reflections formed between the transmitting and receiving end of the transmission line. A common method of terminating a RS-485 type of transmission line is to connect a so-called termination resistor, between the wires and at both ends of the transmission line. Even when there are more than two devices on the same transmission line, the termination resistors are needed only at the ends of the transmission line. The termination resistor must be selected so that its resistance matches the characteristic impedance of the transmission line as close as possible (typical values range from 100 to 120  $\Omega$ ). When using a RS-422 type of connection the termination resistor is connected only at each of the receiving ends. Termination resistors are particularly important when using long transmission lines and/or high data transfer speeds.

### 3 RF INTERFACE

The SATELLINE-3AS(d) has a single TNC-type connector with impedance of 50  $\Omega$ . The SATELLINE-3AS Epic model has two antenna connectors, the one on the left being both for transmitting and receiving and the one on the right being for receiving only.

Note for SATELLINE-3AS Epic model: the diversity reception i.e. the secondary receiver of the SATELLINE-3AS Epic can be switched off (in a single antenna application) by changing the setting *Diversity Mode* OFF in the programming menu. See Chapter 9.1.2.

It is recommended to terminate the unused antenna port by placing a suitable cap on the TNC connector.

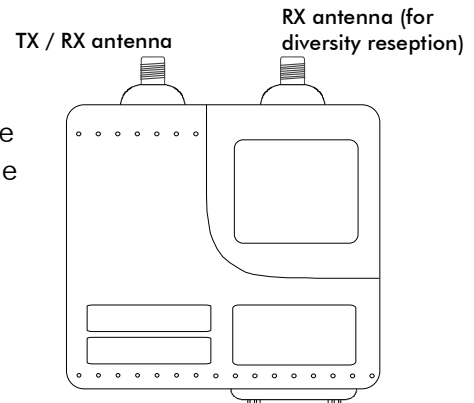

When ordering the radio modem, the frequency band to which the radio modem will be tuned to at the factory must be defined. The user can change the frequency of the radio modem afterwards by  $\pm 1$  MHz from the centre frequency (basic tuning range), or inside 2 X 2 MHz frequency bands when using the special Dual Band version. Of course, all local regulations set forth by the authorities must be taken into consideration. The 869 MHz model contains ten 25 kHz channels.

The data speed of the radio interface depends on the chosen radio channel spacing. A channel spacing of 25 kHz enables a data speed of 19200 bps and a channel spacing of 12,5 kHz enables, correspondingly, a data speed of 9600 bps. The data speed of the radio interface is always fixed (19200 bps or 9600 bps) irrespective of the data speed of the serial interface. If the data speeds of the radio interface and the serial interface differ from each other, the radio modem will buffer the data in transfer temporarily, so no data loss will occur. The radio channel spacing is set at the factory and cannot be changed afterwards.

#### 3.1 Transmitter

The output power of the transmitter is adjustable. The greatest allowable power depends on limits set by local authorities, which should not be exceeded under any circumstances. The output power of the transmitter should be set to the smallest possible level which still ensures error free connections under variable conditions. Large output power levels using short connection distances can, in the worst case, cause disturbances to the overall operation of the system.

OUTPUT POWER	dBm	3AS	3AS 869 MHz	3AS Epic
10 mW	+10	•	•	
20 mW	+13	•	•	
50 mW	+17	•	•	
100 mW	+20	•	•	
200 mW	+23	•	•	
500 mW	+27	•	•	
1 W	+30	•		•
2 W	+33			•
5 W	+37			•
10 W	+40			•

Possible output power settings of the SATELLINE-3AS –line of radio modems.

**NOTE!**

Setting the radio data modem output power level to that which exceeds the regulations set forth by local authorities is strictly forbidden. The setting and/or using of non-approved power levels may lead to prosecution. SATEL and its distributors are not responsible for any illegal use of its radio equipment, and are not responsible in any way of any claims or penalties arising from the operation of its radio equipment in ways contradictory to local regulations and/or requirements and/or laws.

SATELLINE-3AS Epic radio modem is shipped with two different cooling elements. If the transmitter of the radio modem is to be ON full power over 20 % of the operating time, additional cooling is required.

### 3.2 Receiver

The sensitivity of the receiver depends on the channel spacing of the radio modem (=data speed of the radio interface) and on the mode of the FEC (error correction) according to the table below:

	FEC OFF	FEC ON
25 kHz	-110 dBm	-113 dBm
12,5 kHz	-112 dBm	-115 dBm

Effect of settings on the receiver sensitivity

The Signal Threshold Level setting of the receiver determines a level, above which the search for the actual data transfer signal is active. It is recommended that values given in the table are used. If the Signal Threshold Level setting is set too low (the CD-LED is ON constantly), it is possible that the receiver is trying to synchronise itself with noise, in which case, the actual data transmission might remain unnoticed. Alternatively, weak data transmissions will be rejected, even though they would be otherwise acceptable.

SATELLINE-3AS Epic –radio modem contains two separate receivers, and a selection is made between the received signals in order that the stronger/better signal is used. By using this method, the signal fading caused by multipath propagation will be smaller than if just one antenna and receiver are used. The recommended minimum distance between receiving antennas is  $\frac{3}{4}$  wavelengths, which at a frequency of 450 MHz corresponds to a distance of 50 cm.

### 3.2.1 RSSI-signal

RSSI-signal (Received Signal Strength Indicator) (pin 5 of the D-type connector) gives an indication of the strength of the received radio signal. This signal can be used to determine the approximate signal level. The curve on the following diagram describes a typical relationship between the received signal strength and the voltage at pin 5. Please note that only the RSSI signal of the right side receiver of SATELLINE-3AS Epic is connected to the pin 5.

RSSI value of the last received message can also be requested locally by using a SL command (SL@R?, see chapter 9.3.3). The RSSI value is available 7s after the reception of the message. After that the value is returned to zero. SATELLINE-3AS Epic responds by the stronger RSSI value of the two receivers.

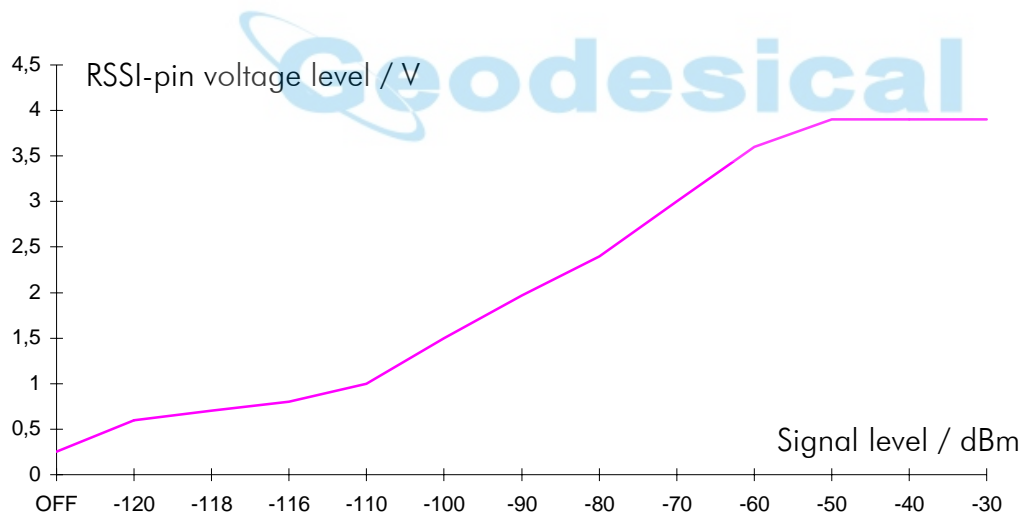

#### **NOTE!**

SATELLINE-3AS(d) and SATELLINE-3AS(d) Epic radio modems marked with the text "E2" on the serial number label (all SATELLINE-3AS(d) radio modems delivered since mid-June 2004) are NOT equipped with RSSI pin by default, because it requires a special hardware assembly. If RSSI is required it must be clearly stated in the order. Note also that Serial Port 2 (RS-232/485/422) and RSSI pin options are alternative.



### **3.3 Priority RX/TX**

SATELLINE-3AS offers a *Priority* setting, which selects the priority between reception and transmission. The setting can be changed in *Programming Mode*. By default, transmission has higher priority than reception i.e. the default value is Priority TX.

*Priority TX* means that a terminal device attached to a radio modem decides the timing of the transmission. The transmitter is immediately switched on when the terminal device starts to output data. Should reception be in progress, the radio modem will stop it and change to a transmit state. There is no need to use any handshaking for the control of timing.

*Priority RX* means, that a radio modem tries to receive all data currently in the air. If a terminal outputs data to be transmitted (or an SL command) it will be buffered. The radio modem will wait until the reception has stopped before transmitting the buffered data. This will result in timing slacks to the system, but decreases the number of collisions on the air, this is particularly useful in systems based on multiple random access.

To toggle the *Priority* setting in the programming menu, select:

1) Priority    RX / TX

If the Repeater Function has been set on (see chapter 6.1), priority setting is automatically switched to RX mode.

### **3.4 Error correction**



Another new feature of the SATELLINE-3AS is the addition of an error correction mode called the FEC-method (**F**orward **E**rror **C**orrection). FEC-function is switched ON (or OFF) by using the *Programming Mode*. When activated, the FEC-function will cause the SATELLINE-3AS to automatically add additional error correction information, which increases the amount of transmitted data by 30 %. It is used by the receiving radio modem to correct erroneous bits - as long as the ratio of correct and erroneous bits is reasonable.

Error correction improves the reliability of data transfer via the radio interface especially in unfavourable conditions. FEC-function should be used when link distances are long and/or if there are many disturbances in the radio channels used. The use of the FEC-function will, however decrease the data transfer throughput of data by about 30 %. For a listing of exact delays introduced by using FEC-function, see Chapters 15.1 and 15.2.

To switch the FEC-function ON in the *Programming Mode*, select:

1) Error correction    ON

#### **NOTE!**

All radio modems which are to communicate with each other must have the same setting for FEC (ON or OFF). If the transmitting radio modem and the receiving radio modem have different settings, data will not be received correctly.

### 3.5 Error checking

When the error checking is switched on, the radio modem will add a checksum to the transmitted data. When the data is received, the checksums are verified before data is forwarded to the serial port.

Switching the error checking ON in the *Programming Mode*, select:  
2) Error check ON

### 3.6 Dual Band version

SATELLINE-3AS(d) radio modem is also available as a special "Dual Band" version. The radio transceiver of the Dual Band version offers two times two MHz frequency bands, and radio modem can be reprogrammed to operate at any channel within those two bands. Frequency bands are tuned at the factory and the maximum separation between the highest and the lowest frequency is 12 MHz (see the diagram on next page).

The centre frequency ( $f_c$ ) is set to the middle of the two frequency bands at the factory. When using the SL-commands please note that SL&F=nnn.nnnn is the only command for frequency change that works in all cases. (SL&+/-=nn command can be used only when the required value for nn does not exceed 99.)

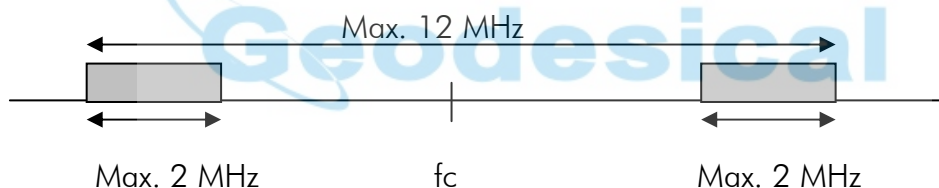

**NOTE!**

SATELLINE-3AS(d) Dual Band is a special hardware version, and the frequency adjustment is made case by case. Before starting the system design procedure please contact the manufacturer for checking the technical details.

### 3.7 Dual Channel function

By setting the "Dual Channel" function on, the SATELLINE-3AS radio modem can transmit and receive data on separate channels. The radio modem is initially at the receive channel. Data flow on the TD line starts automatically the frequency shifts to the transmit channel. The delay caused by the frequency shift before the actual data transmission sequence is 40 ms, and the same is needed for the return to the receive channel after transmission.

The extra delay from a modem to another is shown below:

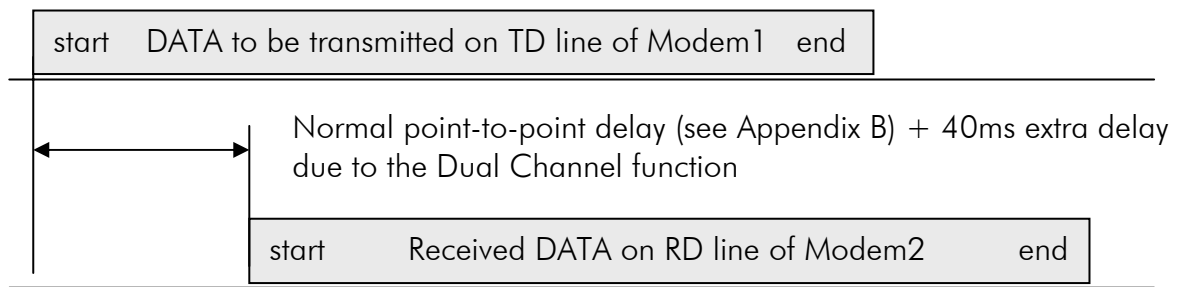

The table below specifies the use of the frequency bands vs. Dual Channel settings.

	Band 1 (Active channel)	Band 2
Dual Channel selected	Transmit Channel	Receive Channel
Reverse Dual Channel selected	Receive Channel	Transmit Channel

The separation between transmit and receive frequencies is equal to the separation between the lower limits of the specified frequency bands (Lower limit band 1 and Lower limit band 2). Frequency bands are set in such a way that the other band covers the receive frequencies and the other includes the transmit frequencies. See below.

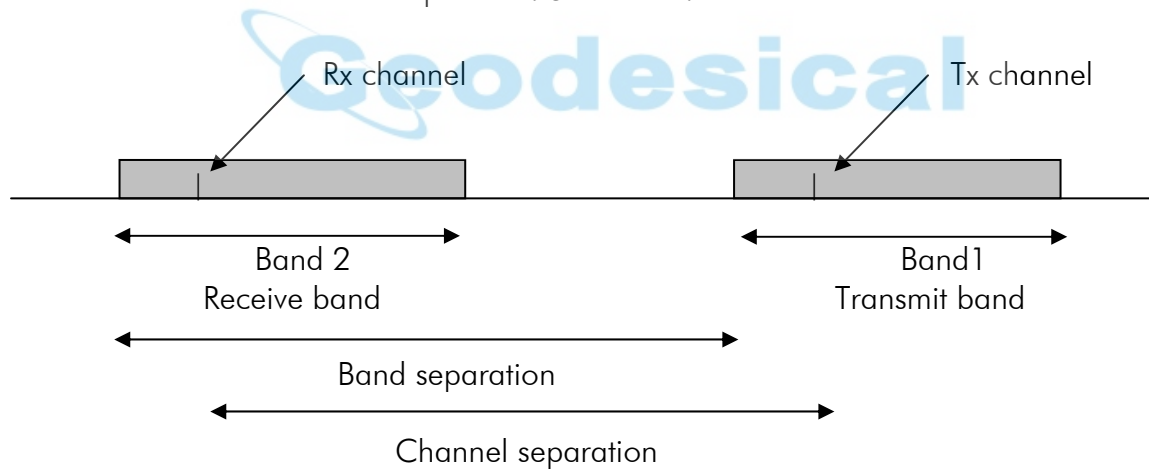

The frequency bands for Dual Channel function can be set within the standard operational band of 2 MHz, or the special Dual Band hardware version may be used for the larger frequency separation (up to 10 MHz). With the help of SL commands the modem can be set to Single, Dual or Reverse Dual Channel mode (Single Channel = normal one channel mode).

The dual channel settings can be changed also by the SL command, see chapter 9.3.1.

### **3.8 Free Channel Scan (FCS) function**

Free Channel Scan (FCS) is designed for one-way transmission between one transmitter and one or more receivers when there are at least two different radio frequencies available. The transmitter monitors the noise level of the channels between the transmissions and finds the best transmission channel. The receivers scan and follow the frequency of that particular transmitter consequently.

The feature is beneficial e.g. for the applications in land surveying or when license free channels are used and there could be other transmitters using the same channels.

The FCS function is supported starting from the software version 3.07.

To make the use easier SATEL provides the FCS terminal software for your PC. Using the program it is easy to configure the radio modems to use the FCS function. There is also a scanning tool for measuring the power level of the selected radio channels. A more detailed description of FCS function and FCS terminal software is available from the manufacturer or from the nearest distributor.

A screen snapshot of the FCS terminal software below:

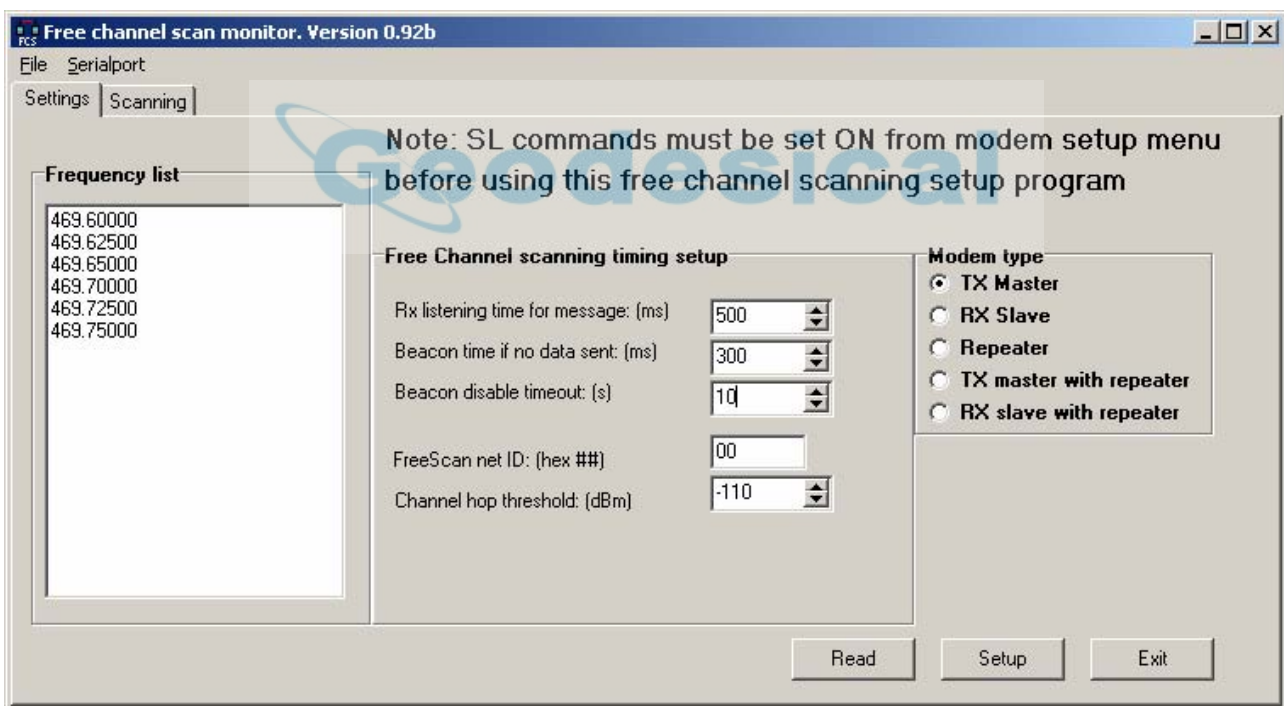

## 4 USER INTERFACE

### 4.1 LED-indicators

There are five (5) LED indicators on the front panel of the radio modem, and they give an indication of the status of the serial port and the radio interface:

LED	Indication	OFF	Red	Orange	Green
RTS	RTS-line status	Inactive	Active		
CTS	CTS-line status	Inactive	Active		
TD	TD-line status	No data	Data		Test Tx active
RD	RD-line status	No data	Data		
CD	Radio status	No signal	Transmission	Noise	Reception

Description of the LED-indicators:

- *RTS* indicates the status of D-connector pin 13.
- *CTS* indicates the status of D-connector pin 6.
- *TD* indicates that the radio modem is receiving data via serial port.
- *RD* indicates that the radio modem is sending data via serial port.
- *CD* indicates the status of the radio interface. The status of the CD-signal on the serial interface may differ from the status of the LED-indicator.

### 4.2 Programming Mode

The settings of SATELLINE-3AS are fully configurable in *Programming Mode* by using a suitable terminal program. The most recommendable set-up is NARS-1F interface adapter, CRS-9 cable, a power supply and the *SaTerm* terminal program. NARS-1F contains a switch to enable easy shifting into the *Programming Mode*. Other suitable terminal programs and cables may also be used.

The radio modem will shift into the *Programming Mode* by connecting the D-connector pin 12 to ground (GND). When using the NARS-1F this can be accomplished by moving the slide switch downwards.

In the *Programming Mode*, the radio modem will use serial port **PORT1**, with settings 9600 bps, N, 8,1 (data transfer speed 9600 bps, no parity, 8 data bits and 1 stop bit). For more detailed instructions for changing each setting, see Chapter 9.1 and 9.2.

### 4.2.1 Changing the settings

- Connect cables (RS-232 cable to PC COM-port, power supply cable to power supply).
- Switch on the PC and start *SaTerm* program (or other terminal program).
- Open a terminal window and then choose "Pr" (in case you are using some other terminal program, set the serial port parameters of the program as follows: 9600 bits/s, 8 data bits, no parity, 1 stop bit, which is always the default in *Programming Mode*).
- Connect PROG-pin to ground (if using the NARS-1F adapter, slide the switch downwards), the radio modem shifts now into the *Programming Mode*. The screen should look similar to the one shown in the picture below.
- Make desired changes to the settings.
- Save changes by pressing "E" in the main menu. If you don't want to save changes, press "Q".
- Disconnect PROG-pin from ground (if using the ARS-1F adapter, slide the switch upwards), the radio modem should now return to the *Data Transfer Mode*.

```
***** SATEL 3AS *****
SW Version x.yz / HW TC4x
-----
Current settings
-----
1) Radio frequency    468.2000 MHz ( CF 468.2000 MHz, spacing 25 kHz )
2) Radio settings    Tx power level 500 mW / Signal threshold -110 dBm / FCS OFF /
TX start delay 0 ms / Diversity RX OFF / EPIC PWRSave OFF
3) Addressing        RX address OFF / TX address OFF /
RX address to RS port OFF / TX address autoswitch OFF
4) Serial port 1     ON / 19200 bit/s / 8 bit data / None parity / 1 stop bit
5) Serial port 2     OFF / 19200 bit/s / 8 bit data / None parity / 1 stop bit (RS-485)
6) Handshaking       CTS Clear to send / CD RSSI-threshold / RTS Ignored
7) Additional setup  Error correction OFF / Error check OFF / Repeater OFF /
SL-commands OFF / Priority TX
8) Routing           OFF
9) Tests             OFF
A) Restore factory settings
E) EXIT and save settings
Q) QUIT without saving

Enter selection >
```

### **4.2.2 Restoring factory settings**

Selecting menu selection "A" may restore factory settings.

```
Enter selection >A
Restore factory settings
-----
Do you want to restore factory settings? (Y/N)>
```

Factory settings are restored by selecting "Y" (YES). By pressing any other button current settings will remain active. The modem will ask this question twice to make ensure that this is a valid command.

### **4.3 Display and push buttons (SATELLINE-3ASd (Epic))**

SATELLINE-3ASd includes a LCD-display (Liquid Crystal Display) with a backlight. In the *Data Transfer Mode* the display will show the operating settings of the radio modem, radio field strength and the charge remaining in the SATELSET or SATEL-321 battery pack. By using the push buttons and the LCD-display, it is possible to change most of the settings of the radio modem, without the need for an external terminal. The display backlight illuminates automatically as soon as a button is pressed

The radio modem will shift into the *Programming Mode* by pressing the SET-UP-push button ( ■ ) The LCD-display will then briefly display the model of the radio modem and the version number of the installed software, after which the main menu appears which is a listing of the changeable parameters.

With the help of the main menu, sub-menus can be selected which in turn can be used to change the settings. You can always return to the previous higher level of the menu structure by pressing the CANCEL (or BACK) push button. Pressing the ▲ or ▼ button changes settings. Selections are confirmed by pressing the SELECT or SET button. In case of numerical values the digit to be changed is selected by pressing the NEXT button (see following page).

**SATELLINE-3ASd / 3ASd Epic LCD-DISPLAY AFTER POWER-UP**

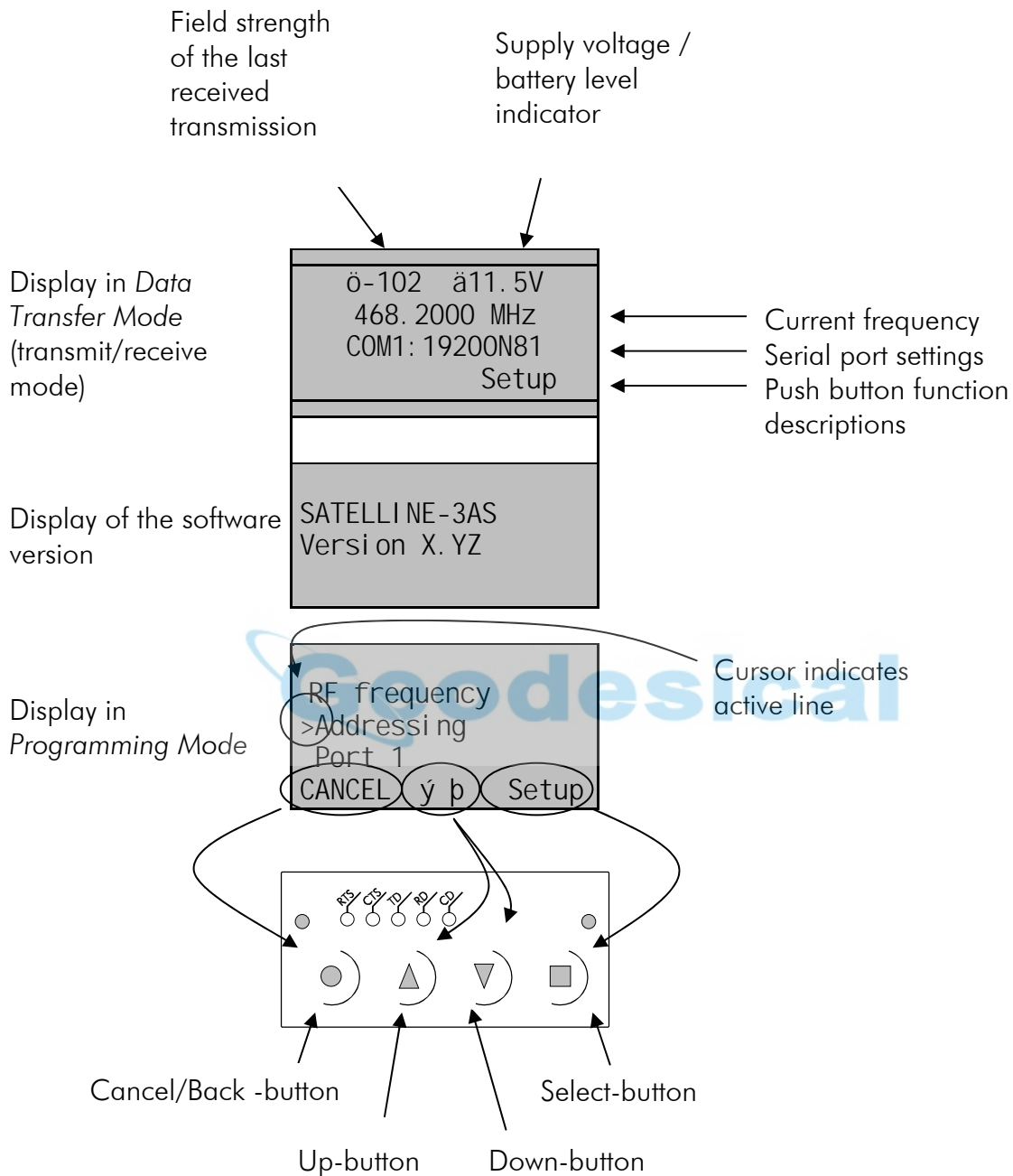



## 5 TRANSPARENT DATA TRANSMISSION

### 5.1 Serial interface, data format

The SATELLINE-3AS radio modem serial interface uses an asynchronous data format. No external synchronising signal is needed, since necessary timing information is acquired from the start and stop bits transmitted before and after each data field bits (byte).

The data transfer speed of the serial interfaces can be set to 300, 600, 1200, 2400, 4800, 9600, 19200 or 38400 bps (**bits per second**). The length of the data field must be 7, 8 or 9 bits. When using a data field length of 7 or 8 bits, a parity bit may also be used.

One character to be transmitted will thus contain a start bit; the data bits (which define the specific character in question); an optional parity bit and one or two stop bits. The overall length of one character is therefore 10, 11 or 12 bits. This should be taken into account when calculating the data throughput capability of a system. In other words, the number of start, stop and parity bits must be considered. A useful rule of thumb is that at a data transfer speed of 9600 bps, the transmission of one character will require roughly one millisecond (1 ms).

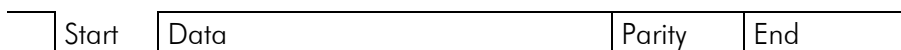

Asynchronous character data format

**Example:** With an 8-bit data character length and taking, for example, a decimal value of "204", (which corresponds to a binary value of "11001100") and with a start bit value of "0", parity bit set to either "NO" (NONE), "0" or "1" and with a stop bit value of "1", the possible combinations are listed in the table below:

DATA FORMAT	CHARACTER	CHARACTER LENGTH
8 bit, no parity, 1 stop bit	0110011001	10 bit
8 bit, even parity, 1 stop bit	01100110001	11 bit
8 bit, odd parity, 1 stop bit	01100110011	11 bit
8 bit, no parity, 2 stop bits	01100110011	11 bit
8 bit, even parity, 2 stop bits	011001100011	12 bit
8 bit, odd parity, 2 stop bits	011001100111	12 bit

If the settings of data speed, character length, parity or the number of stop bits differ between the radio modem and the terminal, errors will be introduced into the transferred data. The serial port settings of each individual radio modem in a system can all be different apart from the data length setting (7, 8 or 9 bits), which must always be the same in each individual radio data modem. In other words, the serial port used, the data transfer speed, parity and number of stop bits; can be different in different parts of a same system. This is especially useful where one part of the system uses an RS-485 serial port and another part uses the RS-232 serial port. In other words, radio modems may also be utilised as serial port adapters in addition to the more common role of wireless data transfer.

The serial port settings can be changed in the *Programming Mode*.

## **5.2 Handshake lines**

When using the RS-232 serial interface, handshake signals can be used to control data transfer. Handshake signals are used, for example, by the radio modem to inform the terminal that the radio channel is busy, and that it cannot initiate transmission. The terminal can also control the radio modem via RTS-line.

Line	Direction
CTS	To terminal
RTS	To modem
CD	To terminal

A common way of using handshaking signals is to monitor the CTS-line and ignore the others. Usually the terminal is fast enough to handle the data received by the radio modem, so the use of RTS-line is not necessary.

Handshaking is not needed if the system protocol is designed to prevent collisions (data contention) by the use of polling, or if there is little traffic and also if there is no harm from occasional data contention situations (several radio modems try to transmit at the same time).

### **5.2.1 CTS-line**

The options for CTS-line are:

#### **1) Clear To Send**

Operation is similar to SATELLINE-2ASxE. CTS is active when the radio modem is ready to accept data for transmission. CTS will shift into inactive state during data reception, and when a pause (packet end) is detected in transmitted data. CTS shifts back into active state either when reception ends, or the radio modem has finished transmission. CTS will also shift into inactive state where the serial interface data transfer speed is greater than the radio interface transfer speed, and if the transmit buffer is in danger of overflowing.

#### **2) TX buffer state**

CTS will shift into inactive state only if the radio modem transmits buffer is in danger of overflowing.

### **5.2.2 CD-line**

The options for CD-line are:

#### **1) RSSI-threshold**

Operation is similar to SATELLINE-2ASxE. CD is active whenever a signal with a level exceeding the level required for reception exists on the radio channel. It doesn't make any difference if the signal is an actual data transmission, a signal of a radio transmitter not belonging to the system,

or even an interference signal caused for example, by a computer or a peripheral device. CD is also active when the radio modem in question is transmitting.

### 2) Data on channel

CD will switch to active state only after recognition of a valid data transmission. CD will not react to interference signals.

### 3) Always ON

CD is always in the active state. This option can be used with terminal equipment, which use the CD-line as an indicator of an active connection (the radio modem can transmit and receive at any time).

## 5.2.3 RTS-line

The options for RTS-line are:

### 1) Ignored

RTS-line status is ignored.

### 2) Flow control

The radio modem transmits data to the terminal device only when the RTS-line is active. Non-active state of the RTS-line will force the radio modem to buffer the received data. This option is used if the terminal device is too slow to handle data received from the radio modem.

### 3) Reception control

RTS-line controls the reception process of the radio modem. An active RTS-line enables reception (as normal). Non-active RTS-line will interrupt reception process immediately, even if the radio modem is receiving a data packet. This option is used to force the radio modem into WAIT State for an immediate channel change.

## 5.3 Timing and delays during data transmission

When using a radio modem for data transmission, certain delays will be formed through the use of a radio interface and from the radio modem circuitry itself. These delays exist when the radio modem switches from *Standby Mode* to *Data Transfer Mode* and during reception and transmission of data. For detailed delay values in each case see Appendix B.

### 5.3.1 Data buffering in the radio data modem

Whenever the radio modem is in *Data Transfer Mode* it monitors both the radio channel and the serial interface. When the terminal device starts data transmission the radio modem switches to transmission mode. At the beginning of each transmission a synchronisation signal is transmitted and this signal is detected by another radio modem, which then switches into receive mode. During the transmission of the synchronisation signal the radio modem buffers data into its memory. Transmission ends when a pause is detected in the data sent by the terminal device,

and after all buffered data has been transmitted. When the serial interface speed is the same or slower than the speed of the radio interface, the internal transmit buffer memory cannot overflow. However, when the serial interface speed exceeds the speed of the radio interface, data will eventually fill the transmit buffer memory. In this instance, it will take a moment after the terminal device has stopped transmission of data for the radio modem to empty the buffer and before the transmitter switches off. The maximum size of the transmit buffer memory is one kilobyte (1 kB). If the terminal device does not follow the status of the CTS-line and transmits too much data to the radio modem, the buffer will be emptied and the transmission is restarted.

In the receive mode, the buffer works principally in the above described way thus evening out differences in data transfer speeds. If the terminal device transmits data to a radio modem in receive mode, the data will go into the transmit buffer memory. Transmission will start immediately when the radio channel is available.

### **5.3.2 Optional start delay in transmit mode**

The radio modem can be configured to delay the beginning of a radio transmission by 1...65000 ms. This function can be used to prevent packet contention in a system, where all substations would otherwise answer a poll of a base-station simultaneously. During this delay data sent to the radio modem is buffered. Although the priority setting is "RX" (see chapter 3.3), radio modem is prevented to change over to receiving mode during the period of the TX delay. If this function is not needed, the delay time should be set to 0 ms.



## **5.4 Tests**

The radio modem can be switched to the *Test Mode*, where it will send a test packet on the radio channel. The test packet is a normal data transmission, which can be used, for example, when directing antennas during system installation.

When the test packet transmission has been switched on and saved by using the *Programming Mode*, the transmitting radio modem needs only a power supply and an antenna.

If the channel spacing of the radio modems is 25 kHz, it is recommended to use 38400 bps as a serial data speed of the receiving radio modem. In the case of 12.5 kHz channel spacing the data speed of 19200 bps is recommended.

There are two *Test Modes*:

### **Short data block test**

In this test mode the radio modem sends a short test string which is preceded by a consecutive number and it ends to the line feed character. The short data block is repeated continuously after 1 s break.

Short data block test is suitable for running data communication tests. Error-free reception of data can be monitored using a suitable terminal program.

### Example of a short data blocks:

```
00 This is a testline of SATELLINE-3AS radio modem
01 This is a testline of SATELLINE-3AS radio modem
02 This is a testline of SATELLINE-3AS radio modem
```

### Long data block test

Long data block consists of character strings which are repeated without breaks 50 s time period. After 10 s break the test transmission is started again.

Long block data test can be used for measuring Tx output power, standing wave ratio (SWR) of the antenna system or received signal strength at Rx stations. Please note that SATELLINE-3AS Epic has to be the version equipped with a cooling element if Long block data test is set on at higher than 1 W Tx output power.

### Example of a long data blocks:

```
This is a long testline of SATELLINE-3AS radio modem
This is a long testline of SATELLINE-3AS radio modem
This is a long testline of SATELLINE-3AS radio modem
```

The strength of the received signal can be monitored using the LCD-display of the receiving radio modem or by measuring the voltage level of pin RSSI.

The logo for Geodesical, featuring the word "Geodesical" in a light blue, sans-serif font. A stylized blue line graphic resembling a globe or a path curves around the letters "G" and "e".

#### **NOTE!**

If the test mode has been set ON, it is NOT especially indicated. Remember to switch it OFF before starting the normal data transfer.

## 6 REPEATER MODE AND ADDRESSING

Repeaters and addressing may be used to extend the coverage area of a radio modem network, and to direct messages to selected radio modems in the network. In large systems, with several repeaters and formed repeater chains, it is often practical to use routing instead of plain addresses. For more information on routing, see Chapter 7.

### 6.1 Repeater

In circumstances where it is necessary to extend the coverage area of a radio modem network, SATELLINE-3AS radio modems can be used as repeater stations.

The maximum size of a repeated data packet is 1 kB (kilobyte). The *Repeater Function* is switched on using the *Programming Mode*. In the repeater mode the radio modem will function as a totally independent unit, which means that only a power supply and a suitable antenna are needed. Other devices are not necessary.

A radio modem acting as a repeater can also be used to receive and transmit data. In repeater mode the radio modem will transmit the received data to the serial interface in a normal fashion. The difference being that the received data will be buffered into the buffer memory. After reception the radio modem will re-transmit the buffered data using the same radio channel as in reception. Data received through the serial interface a radio modem in repeater mode will transmit normally.

The same network may include several repeaters, which operate under the same base station. Repeaters may also be chained; in which case a message is transmitted through several repeaters. In systems with more than one serial or parallel chained repeater, addressing or routing protocol must be used to prevent a message ending up in a loop formed by repeaters, and to ensure that the message finally reaches only the intended radio modem.

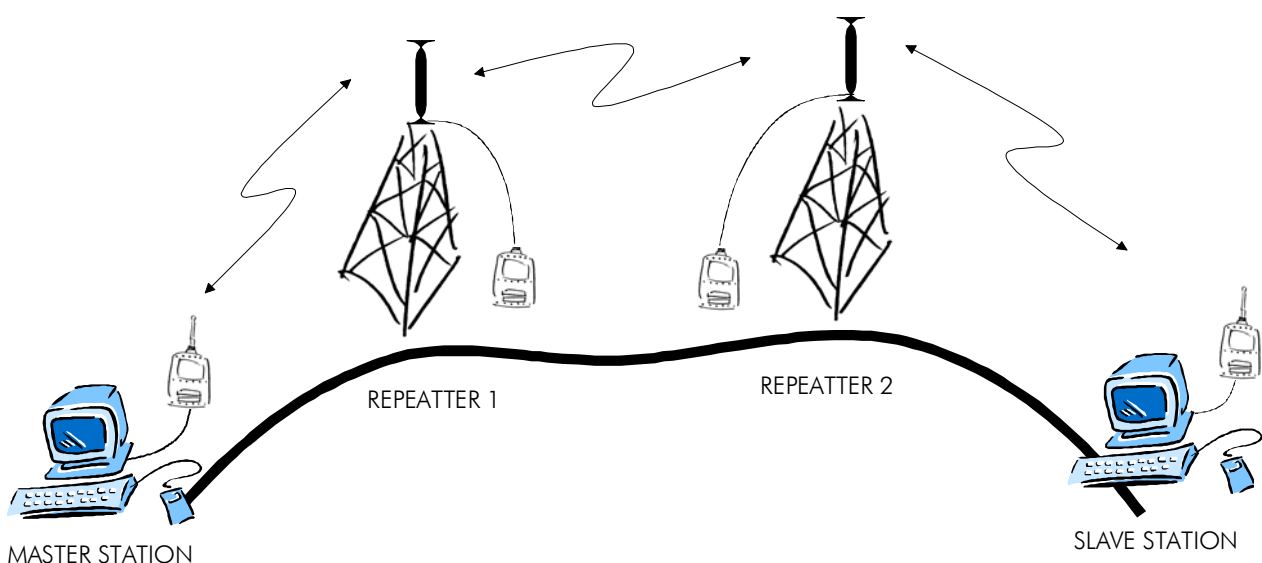

## 6.2 Addressing

Addresses can be used to route a data message to the desired destination or to separate two parallel networks from each other. In networks with repeaters it is usually necessary to use addresses to prevent data messages from ending up in loops formed by repeaters. In case of setting the "Message Routing" function in use, Tx / Rx addresses are ignored by the modem software.

SATELLINE-3AS radio modem allows the use of individual addresses both for reception and transmission. Addresses can be switched on separately, or simultaneously, in both data transfer directions.

The radio modem contains two transmission and two reception addresses, which are known as the primary address and secondary address. The primary address is used whenever data from the serial interface is transmitted. At the receiving end, the radio modem will receive using either of the two receive addresses.

### **Secondary transmit address is only used in repeater applications.**

Radio modems configured to function as repeaters, will repeat data messages using either the primary or secondary address, depending upon which address was used during the reception of the data message.

**If only one address pair is needed in a network, both addresses must be set the same (TX1 = TX2 and RX1 = RX2).**

It is also possible to transfer the received address onto the serial interface.

The address is composed of two characters totalling 16 bits, resulting in over 65,000 different address combinations. The address is attached to the beginning of each data packet sent by the radio modem. When a radio modem receives a data packet whilst using addressing mode, the radio modem will check the first two characters of each received data packet to ensure that the packet in question was intended for the correct radio modem.

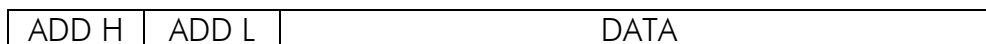

Address may be selected between 0000h...FFFFh (h = hexadecimal, corresponding decimal numbers are 0-65535).

**Example:** address 1234h (4660 in decimal format), where 12h is ADD H and 34h is ADD L.

**Example:** address ABFFh (44031 in decimal format), where ABh is ADD H and FFh is ADD L.

### Transmission:

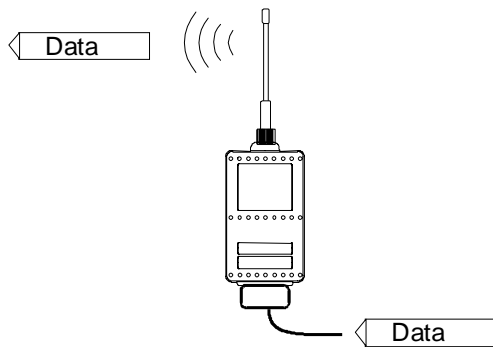

Transmission address has been set OFF. Radio modem will transmit the data packet as such.

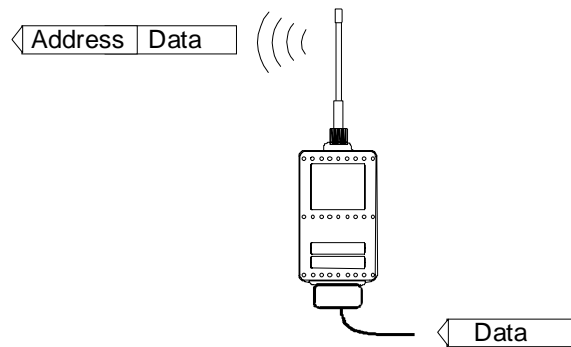

Transmission addressing has been set ON. The radio modem will add the primary TX address to the beginning of the data packet.

### Reception:

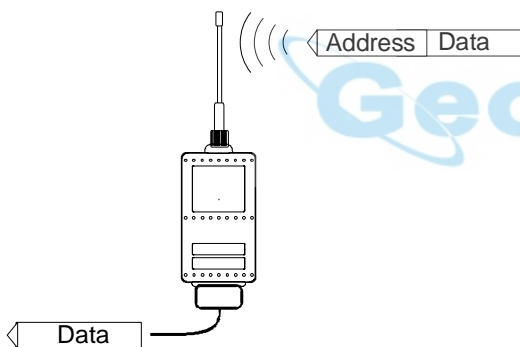

Reception addressing has been set ON and either the primary or secondary RX address of the radio modem is identical to the address of the received data packet.

The radio modem will remove the address and send the actual data to the RS-232 interface.

However, if the "RX Address to RD-line" setting is on, the radio modem does not remove the address.

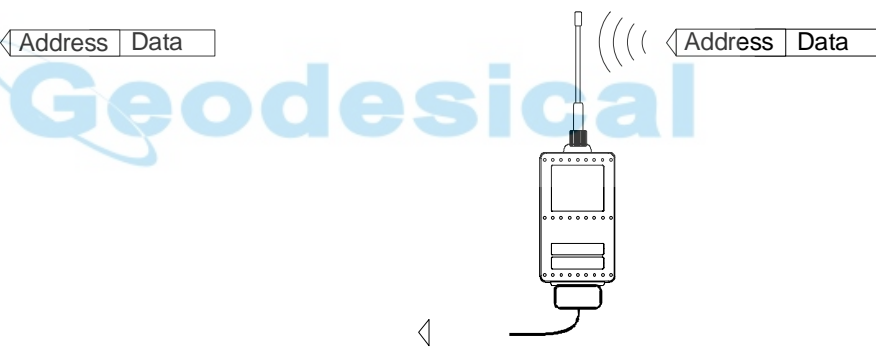

Reception addressing has been set ON, but both the primary and secondary RX addresses of the radio modem are different from the address of the received data packet.

Data does not appear on the RS-232 interface.



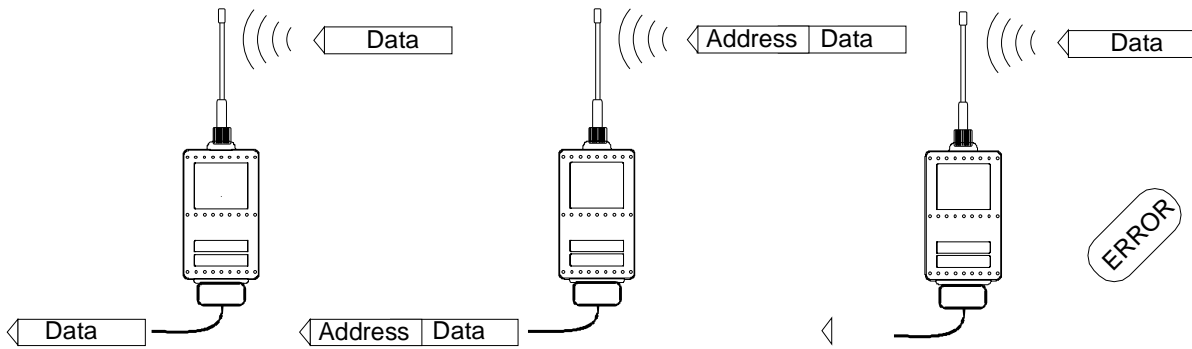

Reception addressing has been set OFF.

The radio modem will transfer all received data to the RS-232 interface.

Reception addressing has been set OFF.

The radio modem will consider the characters of the address as a part of the data and will send all the characters to the RS-232 interface.

Reception addressing has been set ON but there is no address in the data packet.

Data will appear on the RS-232 interface ONLY if the first 2 characters of the data match either of its own RX address. The radio modem will remove those 2 characters of data.



### **6.2.1 Connection between two points**

When forming a connection between two points it is recommended that both the reception and transmission addresses are identical in both radio modems. This is the easiest way to control addresses and the risk caused by interference from other systems operating in the same area is minimal.

**Example:** by setting all addresses of both radio modems to a value '1234', they will accept only those messages which contain this address, and they will use this same value when transmitting data.

If the channel is reserved for use only by the said network, or if the terminal devices are responsible for addressing, it is not necessary to use addressing in the radio modems.

### **6.2.2 System of one base station and several substations**

In systems with several substations, the base station must know to which substation each message is intended, and from which substation each received message originates. Usually terminal devices handle addressing completely, but it is also possible to use the addressing functionality of the radio modems.

For example, if the substation terminal devices are not able to check and form addresses by themselves, addressing may be achieved with the help of the addresses of the radio modems attached to these terminal devices. The base station may, in such a case, define the destination of a message by adding the address of the corresponding radio modem into the beginning of the data packet. The substation radio modem(s) will check the address and the corresponding radio modem will identify and remove the address characters. In a similar way, the substation will add when transmitting to the base station its address characters into the beginning of the data packet, thus defining the origin of the sent data packet. In the base station radio modem, addresses have been switched OFF, so that they are transmitted as is to the base station terminal device for further processing.

### **6.3 Using repeaters and addresses in the same system**

In systems with several repeaters, a substation and a base-station, addresses must be used in radio modems. It is possible to realise also a system with only one repeater without addressing. In such a case, the base station will however hear the message both from the substation and from the repeater, in other words the message is duplicated as it moves along the route.

There are at least two ways of realising such a system depending on the capabilities of the terminal devices in question and on the number of repeaters to be used and on their relative positions to each other.

#### **6.3.1 System with several repeaters**

In systems with several serial or parallel chained repeaters, addressing must be used to prevent messages from ending up in loops otherwise formed by repeaters, and to ensure that only the desired (addressed) radio modem receives the data intended for it.

All radio modems in the network must be set to a state, in which the RX-addressing is switched ON and TX-addressing is switched OFF. Base-station and all substations add an address string in the beginning of the data to be transmitted. In the relaying of the message addressing is used in the following way:

R1 ADD	R2 ADD	S ADD	DATA
--------	--------	-------	------

- The above is the data received from the base station terminal device, containing repeater addresses (R1 ADD, R2 ADD) and the substation address (S ADD). Two characters define each address.

R2 ADD	S ADD	DATA
--------	-------	------

- The above is the same message after being relayed from repeater 1 to repeater 2.

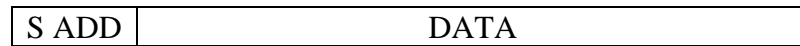

- The above is the same message after being relayed from the last repeater in the chain (repeater 2) to the substation.



- The above is the same message being relayed via the serial interface of the substation radio modem to the terminal device.

In a situation where the substation transmits data towards the base-station the address is formed in a similar way, but the order of the addresses is reversed:

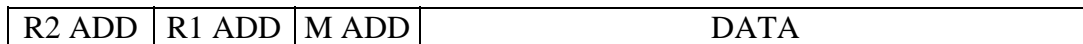

-In the above, R2 ADD is address of repeater 2, R1 ADD is address of repeater 1 and M ADD is the address of the base-station.

### 6.3.2 Repeater chain using address pairs

In a situation where the terminal devices and substations cannot form address fields, but are able to recognise messages addressed to them, alternating address pairs may be used. Transmit address (TX) and receive address (RX) alternate in the order shown in the table below.

Address type	Base-station address	Repeater 1 and the addresses of the substations of the base-station	Repeater 1 substations addresses
TX-address	Address 1	Address 2	Address 1
RX-address	Address 2	Address 1	Address 2

In a network where alternating addresses are utilised, the exact route that is used to relay a message to a certain radio modem is fixed at the time of installation and configuring the system. The order of the addresses must be the same as the order of the route that is used to relay the message to the said radio modem. It should be noted however, that in networks where alternating addresses are used the base-station and substations will hear their own messages repeated.

### 6.3.3 Repeater chain using dual addressing

If the terminal devices cannot add address chains to the beginning of the data packets, a network with several repeaters may still be realised by using dual addressing.

In dual addressing each link (see arrows below in figure) is given a unique address, which will prevent duplication of messages and endless loops in the network. The terminal devices need not add anything to the data.

Usually the primary transmit address is used in transmission (TX1). The secondary transmit address (TX2) is used only if the Repeater Mode is used and the packet to be repeated was received using the secondary reception address (RX2).

In the following example two repeaters are used. It should be noted that each link (arrow) might be uniquely defined with the help of radio modem numbers and data transfer directions. The Repeater Mode should be switched ON only in the radio modems acting as repeaters to prevent the packets from remaining in endless loops in the network.

Repeaters may also act as ordinary substations; in that case the terminal device must wait until the message has reached the end of the repeater chain before sending data.

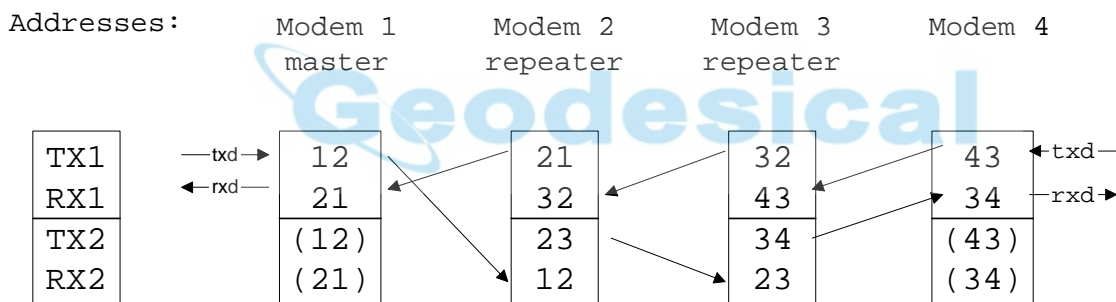

### 6.3.4 Redundant repeater chain

Reliability of a radio data communication system can be improved significantly by designing redundant equipment setup for master and repeater stations. The two repeater chains are separated by proper dual addressing setup. Slave stations need to be able to communicate with the master through the both repeater chains. By using the "TX address autoswitch" function, the slave station modem directs the reply message to the repeater chain from which the request has been received.

If "TX address autoswitch" has been set ON (see chapter 9.1.3), radio modem checks out the RX address of the received message. When the secondary (/primary) RX address is recognised, all the messages coming in from the serial interface will be sent to the air with secondary (/primary) TX address until a message with primary (/secondary) RX address is received from the radio. To avoid fatal complexity in the system, "TX address autoswitch" function can not be set on while Repeater Function is set on.

## 7 MESSAGE ROUTING

### 7.1 Introduction to Message Routing

*Message Routing* is an exciting feature in SATELLINE-3AS and Epic range. This feature allows messages from terminal devices to be automatically routed over the radio modem network to a specified recipient terminal.

In brief, the *Message Routing* works as follows:

- First, a radio modem reads any message coming from the terminal(s) attached to it.
- The radio modem detects the terminal address of the recipient, by seeking a pre-set position inside the message for the address.
- The radio modem checks its internal route table to see, if there is route information corresponding the address it has just found.
- The radio modem transmits a radio frame, which includes
  - the network id (see later)
  - the route information
  - the original user message encapsulated
  - redundant information such as checksums for error checking etc.
- The radio modems along the route relay the frame over the network to the radio modem at the destination.
- The radio modem at the destination first checks the validity of the received radio frame, then extracts the original user message, and finally outputs it the terminal device attached to it.

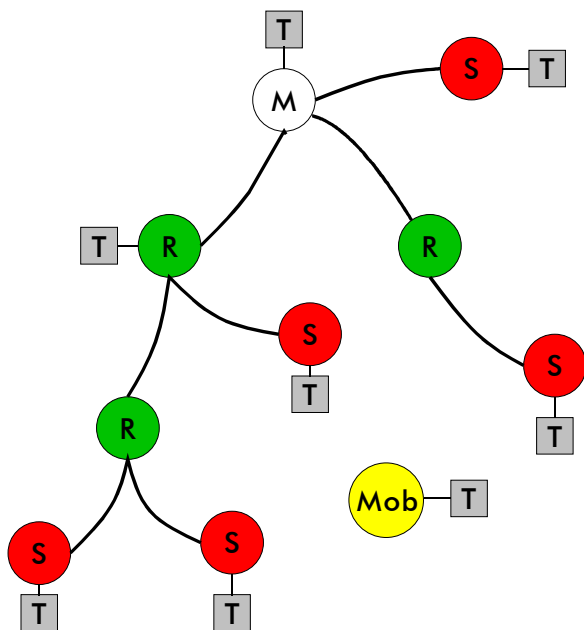

The figure left illustrates a possible structure of a radio modem network.

M = Master station (Central station)

R = Repeater station

S = Slave station

T = Terminal device

Mob = Mobile terminal

Terminals are usually PLC devices that send and receive messages according to a specific user protocol.

*Note:* The term *repeater* used in the context of the *Message Routing* should not be mixed with the *Repeater Mode*, which is a feature independent from the *Message Routing*.

### **7.1.1 Features of Message Routing**

The *Message Routing* feature of the SATELLINE-3AS and Epic is designed to be a fast and transparent to fit real time systems. The features include:

- Transparent to user protocols.
- Easy construction of a network containing several repeaters.
- Any radio modem may operate as a repeater, i.e. dedicated repeaters are not usually needed thus cutting down on costs.
- Large areas of coverage may be implemented by using only one radio channel.
- The use of mobile substations is also possible to some extent.
- The system will be fully deterministic i.e. the transmission delays are predictable. Because of that, the principle of *Message Routing* is connectionless.
- Added redundancy, as a failing radio modem can be, in certain cases, bypassed with another radio modem positioned in the same coverage area.
- *Message Routing* is intended mainly for the protocols based on polling scheme and a single master station.

### **7.1.2 Limitations of Message Routing**

- It is assumed that the position of the address field in the user messages is fixed (some special protocols can be supported though).
- It is assumed that there is only one message at a time inside the network, simultaneous messages could cause collisions.
- The max number of the routes depends on the actual hardware and the software version.
- Operation of the Tx / Rx addresses is automatically blocked in the case of switching the "Message Routing" function on.

### **7.1.3 Getting started with Message Routing**

The design of any radio modem system requires very precise planning. Once the choices between devices, their location, installation, maintenance etc. are clear, the *Message Routing* for the system can be implemented.

Planning your *Message Routing* System

1. Decide which mode of the *Message Routing* suits the system - *Source Mode* or *Virtual Mode*. See the following paragraphs for details.

2. Design a layout of the system describing the settings such as protocol, addresses of the terminal equipment, radio frequencies and so on.

3. Configure the radio modems accordingly. There are two ways to configure the parameters related to the *Message Routing*:

- *SaTerm* PC-program
- Manual configuration in the setup menu.

In either case, please check the chapter on *Settings* before changing the setup of the radio modems.

Finally, when all the radio modems have correct settings, they are ready for further installation.

#### **7.1.4 SaTerm and the configuration of the Message Routing**

*SaTerm* is a PC based program that allows the user to design their required network simply and quickly using a graphical interface to literally draw the network plan on the screen.

- Firstly, a picture of the network is created to show all the radio modems and the intended route that the data is to take.
- Secondly, the required settings are defined in the drawing.
- Finally, the setup of each actual radio modem can be uploaded by connecting the actual radio modems one by one to the COM port, switching them to the programming mode, and clicking the transmit button of *SaTerm*.

Please check the user manual of *SaTerm* for more details.

The figure below shows a typical snapshot taken from a *SaTerm* screen.

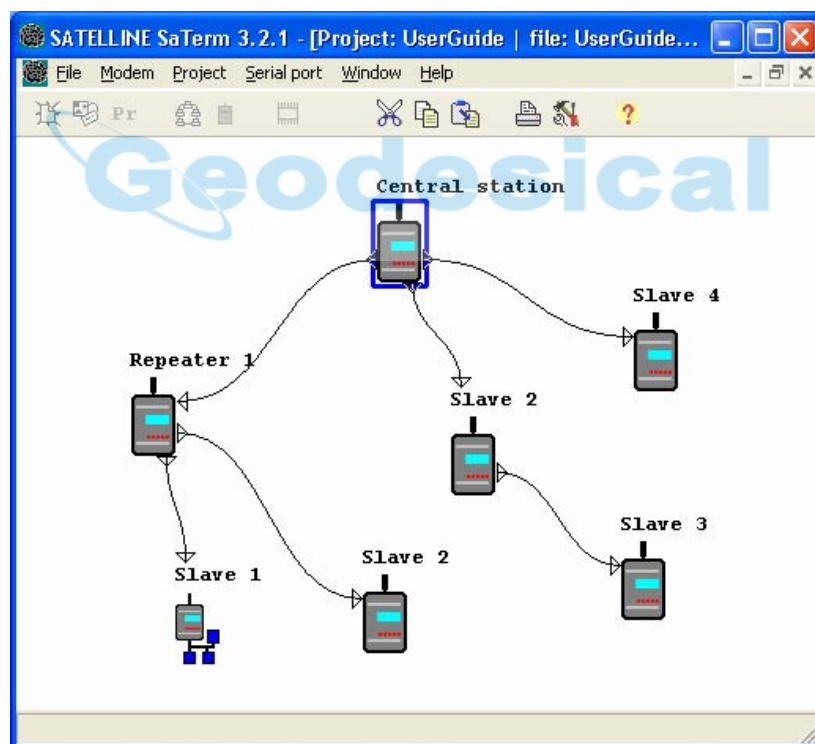

#### **7.1.5 Manual configuration of the Message Routing**

The radio modems can be configured manually via the programming menu. However, this is recommended only if the structure of the network is very simple, or if it is desirable to define such special functions that are not possible to draw using the graphical interface of *SaTerm*. Examples of such cases are for example non tree-structured networks, or the use of same repeaters in several overlapping networks. The operation of the *Message Routing* must be clearly understood before configuring the radio modems manually.

### 7.1.6 Configuration of the protocol in Message Routing

A radio modem will detect the presence of an address used by inspecting the protocol from the message received via the serial interface. On the basis of this user address, all necessary information needed to relay the message to destination is fetched from an internal routing table inside a radio modem. The user protocol is not interpreted; instead, the user address is searched according to its location in the message. The beginning of the packet is located by a preceding pause in the byte stream. Message Routing can therefore be applied to most protocols with fixed address field position.

The position and length of the address is defined by two settings: *Offset* and *Length*.

- Offset defines the number of bytes (0...15) preceding the address.
- Length is the length of the address in the user protocol expressed in bytes (1...4).

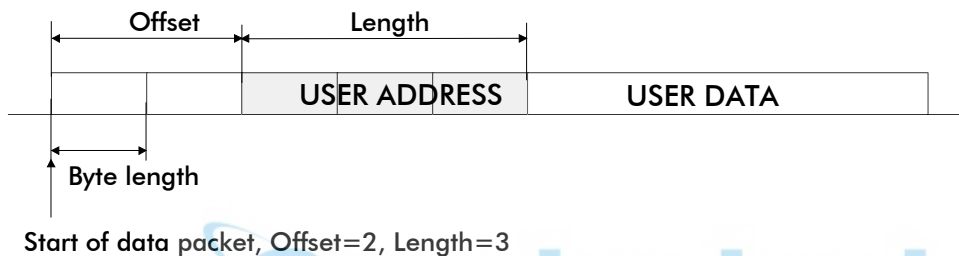

A transmitting radio modem adds a routing header and a tail to the user message. Consequently, a radio modem that receives the message removes the header and tail - so the Message Routing scheme is transparent to the user protocol.



## 7.2 Operating modes of Message Routing

The *Message Routing* has two different operating modes:

- *Source Mode Routing*
- *Virtual Mode Routing*

The most important differences between the two modes are shown in the table below.

Property	<i>Source Mode Routing</i>	<i>Virtual Mode Routing</i>
Summary	Slower, more functions	Faster, less functions
Radio interference tolerance	Yes, over hop function	No
Support for mobile stations	Yes	No
Addition of substations to a network	Only master station needs to be reconfigured	Master station and consecutive repeaters need to be reconfigured
Changing routes	Only master station needs to be reconfigured	All radio modems need to be reconfigured
Maximum length of route	16 hops	No limit
Over hop function	Yes	No
Network ID	Yes	Yes
Storing of routing information	Centralised	Dispersed
Message Routing overhead (bytes)	$10 + 2 \times \text{number of hops}$	9
Maximum length of user protocol message (bytes)	1 kB – Message Routing overhead	1 kB – Message Routing overhead

Other issues common to the both modes:

- The maximum number of terminals depends on the radio network structure and the number of routes.
- Multiple terminal addresses may be attached to a radio modem.
- The maximum length of a terminal address (in the user's protocol) is four bytes (FFFFFFFF in hexadecimal).
- The maximum length of the address of a radio modem is two bytes (FFFF in hexadecimal).

### 7.3 Detailed description of Message Routing

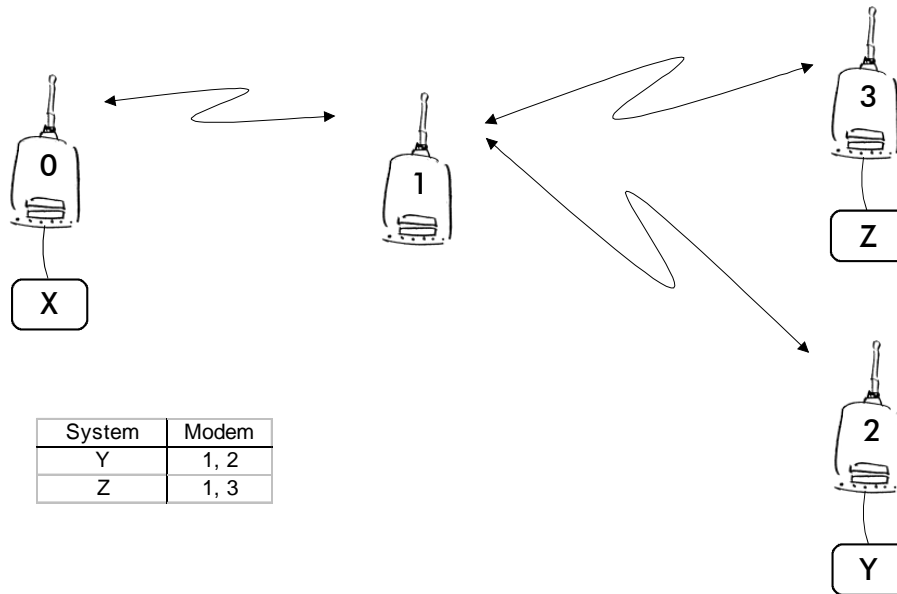

#### 7.3.1 Source Mode Routing

The above figure represents a network containing four (4) radio modems. Each radio modem is given a unique address (0...3). A terminal device has been attached to the three of the four radio modems and they communicate with each other using terminal addresses X, Y and Z, respectively. Radio modem 0 and terminal device X together constitute the base station of the network and all routing information of the network has been programmed into this base station.

When the terminal device X transmits a packet to (e.g.) terminal Y, radio modem 0 will detect the address Y from the data received through the serial port. From the routing table a route 1,2 can be found to which the radio modem also adds its own address to define the route for return data. Radio modem 1 repeats the packet and radio modem 2 removes the address information from the received data packet thereby transferring only the original data to the serial interface. The address information received together with the packet is reversed (2, 1, 0) and saved to be used in the transmission of subsequent reply packets.

#### 7.3.2 Virtual Mode Routing

Please contact SATEL for more information of Virtual Mode Routing.

### 7.3.3 Overhop function in Source Mode Routing

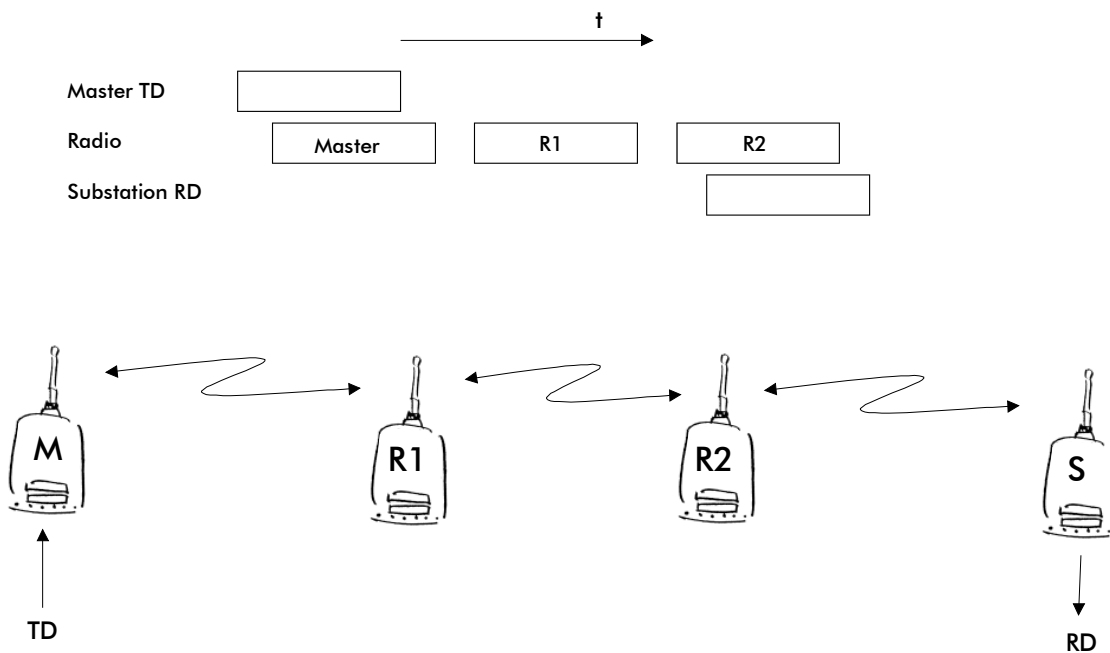

When using repeaters, the same packet is sent via a (radio) channel several times. A radio modem situated in the repeater chain will often hear other radio modems in addition to the immediate neighbouring radio modems. With *Source Mode Routing* the complete address information is sent together with the packets enabling the use of these secondary routes. Usually repeaters have better antennas (and/or antennas placed higher) than normal substations, which means that the distance between two repeaters can be much longer than the distance between a repeater and a substation.

Connections to other than the neighbouring stations of the repeater are not necessarily reliable under all possible (radio) conditions, but they can often be used to keep the network up and running at least partially should a repeater somewhere in the middle of the chain fail. In addition to this, the likelihood of a transmission error decreases if it is possible to listen to more than one transmission since; in this case, it is more likely that at least one of them will be received error-free. It is also possible, that the radio connection is asymmetrical due to the greater output power of a repeater or due to local interference, in which case, data can in fact travel in opposite directions using different routes.

When a repeater receives a message that contains its address but not as the first address in the address field, the packet is stored in a buffer. If the relayed message from the repeater, and the modem having sent the message originally, is not received (due for example, because of radio modem failure or if it has an erroneous checksum), the packet already buffered into the memory is re-sent without any change to the timing (no additional delays are introduced). Because of this, relatively short hop distances can be used, without the likelihood of errors being increasing due to the added number of repeats. A possible error in one of the repeaters does not necessarily cause a total breakdown of traffic.

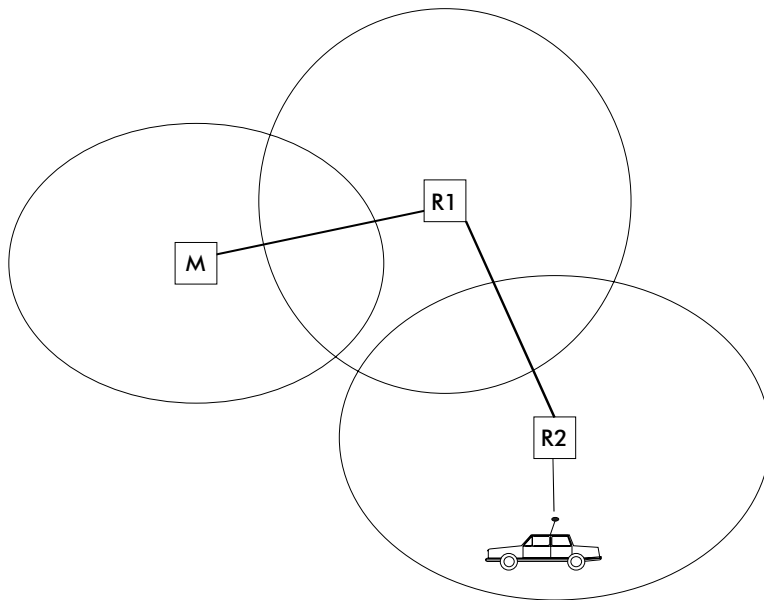

The over hop function allows for the use of mobile substations. In the example above, a mobile substation is first located in the coverage area of repeater R2. The route is defined as M, R1, R2 and vehicle. When the vehicle moves to the coverage area of repeater R1, the radio modem picks the packet already from the transmission of R1. This is then transferred to the serial port using an additional delay, so that the timing does not differ from the first situation where the radio modem of the vehicle was in the coverage area of repeater R2. In this way a collision of the reply transmission and the transmission by repeater R2 is prevented. When the mobile station is transmitting, it is enough that at least one radio modem defined to be a part of the route receives the transmission.

### **7.3.4 Special protocols**

Although the settings of the *Message Routing* can not be set to support all user protocols, there are some special protocols, shown below, supported directly by SATELLINE-3AS radio modems.

- IEC 60870-5-101 is a protocol commonly used in control applications of power lines.
- RP570 protocol

### **7.3.5 Network ID**

The Network ID is a string of up to eight characters, which is used to prevent the reception of the messages coming from an external system. The radio modems operating in the same system using *Message Routing* must have the same Network ID. Only the messages that have a matching Network ID are received.

## 8 Diversity receiver (SATELLINE-3AS Epic only)

SATELLINE-3AS Epic model has two antenna connectors, one solely for reception and the other for both reception and transmission. Diversity reception means that the radio modem selects the best signal from both those received by the two antennas. In this way the reliability of the connection is improved especially in those cases which are subject to a high level of reflections and multipath fading.

### 8.1 Multipath fading

In radio systems (operating at suitable frequencies) it is not necessary to have a direct line-of-sight connection between the master station and a moving substation, because the radio signal propagates by reflecting from buildings and terrain contours e.g. hills. These useful reflections do however cause fading, which can occur when the radio signal experiences a number of reflections on the way to the receiving antenna. Radio signals propagate at the speed of light but if the signal is reflected from several different objects before reaching the receiving antenna the different total path lengths of these reflected signals will cause them to be detected at slightly different times. This means that these detected reflected signals are in different phases. In the worst case scenario, two equally strong signals are in exactly opposing phases thus cancelling each other out and causing the signal level to drop.

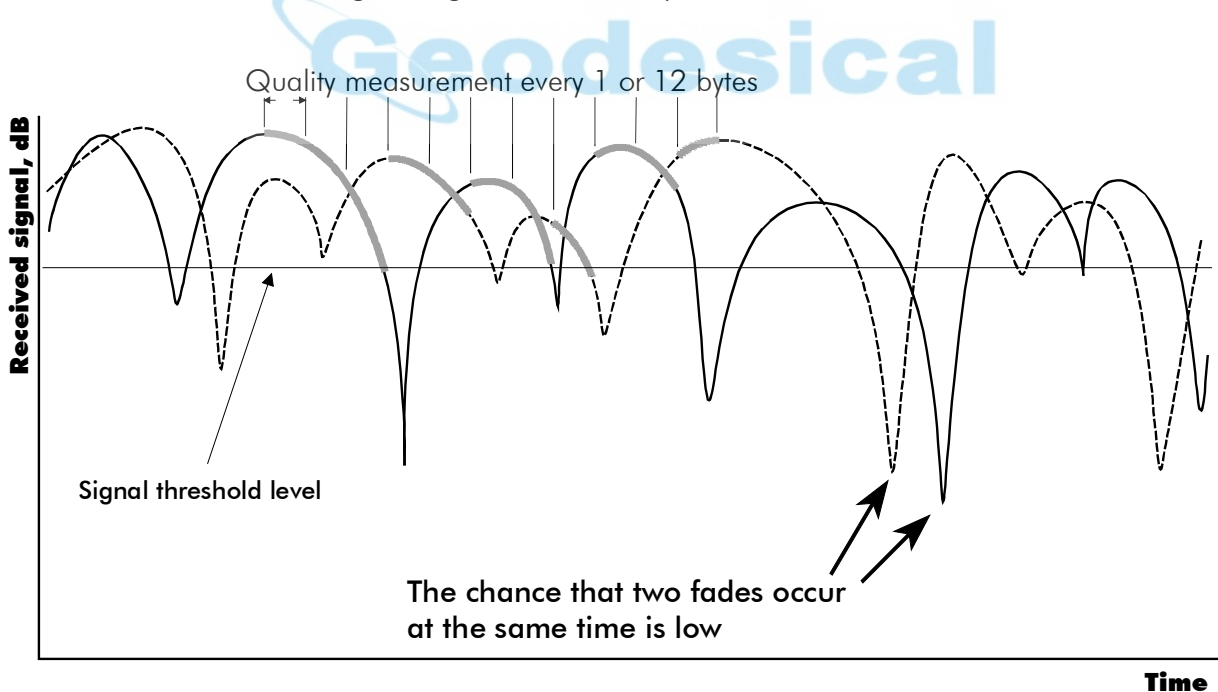

Received signals from two antennas. The selected signals are marked in grey.

## 8.2 Antenna installation

Signal fading appears at half wave intervals and so the best results are achieved by installing the two antennas of SATELLINE-3AS Epic so that the minimum separation distance is  $\frac{3}{4}$  x wavelength used (min. 0.75 m). It is not recommendable to use Miniflex –antennas together with the SATELLINE-3AS Epic model.

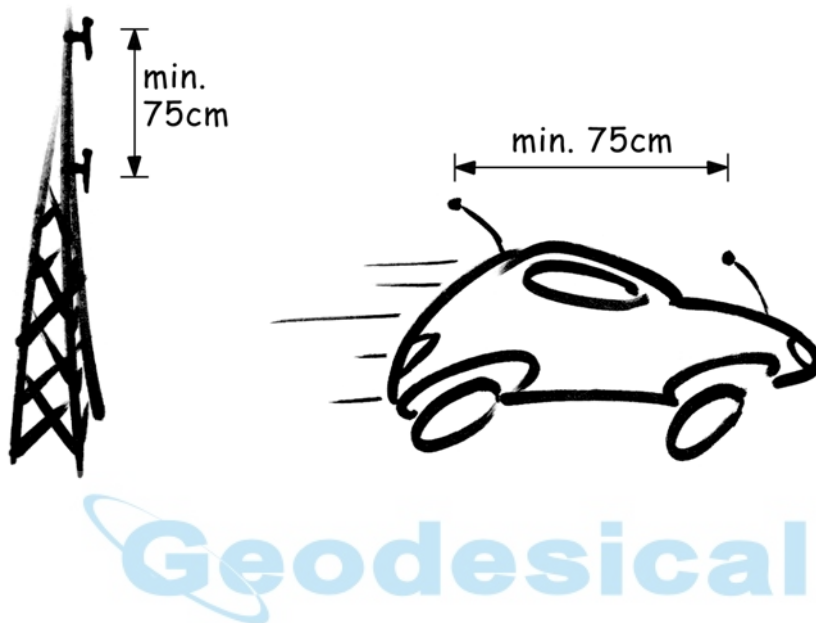

## 9 SETTINGS

The configuration of SATELLINE-3AS radio modems can be easily changed. Simply by connecting pin 12 of the D-connector to ground (GND) the radio modem will switch into *Programming Mode*. Serial port **PORT 1** is used whenever the radio modem is in the *Programming Mode*. The serial port settings are 9600 bps, N, 8,1 (data transfer speed 9600 bps, no parity, character length 8 bits and one (1) stop bit).

SATELLINE-3ASd model contains push buttons and a LCD-display, which can be used to modify configuration settings without the help of an external terminal device. The radio modem will switch into *Programming Mode* by pressing the "SETUP"( ■ )button.

If the SL-command function has been activated active radio channel and addresses can be changed without switching the radio modem into *Programming Mode*. Serial port settings will remain as those defined previously when the radio modem was in *Programming Mode*.

### 9.1 Changing parameters using a terminal device

**PORT 1** of the radio modem is connected to a terminal device or a PC, which is in terminal emulation state. (This can be accomplished by using a suitable program such as the *SaTerm* program or the Windows™ Hyper Terminal program). Check the wiring of the serial port connection cable. Terminal device serial port settings must be set to 9600 bps, N, 8, 1 (data transfer speed 9600 bps, no parity, data length 8 bits and one (1) stop bit). MODE-pin (pin 12 of the D-connector of the radio modem) is then connected to ground (GND). Following this the radio modem will transmit the following message to the terminal (certain configuration settings might differ from the ones shown):

```

-----
***** SATELLINE-3AS *****
SW version x.yz / HW TC4x
-----
Current settings
-----
1) Radio frequency 468.5000 MHz ( CF 468.2000 MHz, spacing 25 kHz )
2) Radio settings Tx power level 10 mW / Signal threshold -110 dBm / FCS OFF /
TX start delay 0 ms / Diversity RX OFF / EPIC PWRsave OFF
3) Addressing RX address OFF / TX address OFF /
RX address to RS port OFF / TX address autoswitch OFF
4) Serial port 1 ON / 19200 bit/s / 8 bit data / None parity / 1 stop bit
5) Serial port 2 OFF / 19200 bit/s / 8 bit data / None parity / 1 stop bit
( RS-485/422 )
6) Handshaking CTS Clear to send / CD RSSI-threshold / RTS Ignored
7) Additional setup Error correction OFF / Error check OFF / Repeater OFF /
SL-commands OFF / Priority TX
8) Routing OFF
9) Tests OFF
A) Restore factory settings
E) EXIT and save settings
Q) QUIT without saving
Enter selection >

```

### 9.1.1 Changing frequency (active radio channel frequency)

The frequency of the active radio channel can be changed by selecting main menu selection "1". In the example below the frequency is changed (468,2000 MHz ⇒ 468,5250 MHz).

```
Enter selection >1

Radio frequency setup
-----
Active channel      468.2000 MHz
Lower limit band 1  467.2000 MHz
Upper limit band 1  469.2000 MHz
Lower limit band 2  467.2000 MHz
Upper limit band 2  469.2000 MHz
Channel spacing     25 kHz

Enter new frequency (MHz) or ESC to previous > 468.5250
```

A list of frequency values will appear on the screen updated with the new active radio channel frequency value:

```
Radio frequency setup
-----
Active channel      468.5250 MHz
Lower limit band 1  467.2000 MHz
Upper limit band 1  469.2000 MHz
Lower limit band 2  467.2000 MHz
Upper limit band 2  469.2000 MHz
Channel spacing     25 kHz

Enter new frequency (MHz) or ESC to previous >ESC
```

Maximum adjustment range of the active radio channel frequency is  $\pm 1$  MHz counting from the factory set centre frequency. Because of possible deviations in each country and/or region concerning the authorised use of the frequency spectrum local authorities may limit this adjustment range. SATELLINE-3AS radio modem can be supplied with the adjustment range divided into two bands (**Band 1** and **Band 2**), and this feature can be utilised in case it is required to limit the arbitrary adjustment of the active radio channel accidentally to a forbidden value. The centre frequency and the frequency band limiting values are factory set and the user cannot change them. The active channel is selected by entering a numerical value.

#### NOTE !

Adjustment of the active radio channel of the radio modem to frequencies other than those allocated and/or allowed by local authorities is strictly forbidden. Use or intended use of forbidden frequencies may lead to prosecution and penalties. SATEL is not responsible for any illegal use practiced with any devices manufactured and/or sold by SATEL and is not liable to pay any damages or compensation caused by such illegal use.



### 9.1.2 Changing radio settings (transmitter output power and receiver sensitivity)

Radio settings which consist of transmitter output power and receiver sensitivity can be configured by selecting main menu selection "2". In the following example both the transmitter output power (1000 mW  $\Rightarrow$  20 mW) and the receiver sensitivity (-110 dBm  $\Rightarrow$  -90 dBm) are changed. Please note with SATELLINE-3AS Epic the output power alternatives are as follows: 1, 2, 5 and 10 W. Selection "4" (Diversity RX) is possible to set ON only with Epic modems.

```

Enter selection >2
-----
Radio setup
-----
1) TX power                10 mW
2) Signal threshold        -110 dBm
3) TX start delay          0 ms
4) Diversity RX            OFF
5) Epic power save         OFF
6) Free channel scan       RX Slave / OFF
7) View hardware info

Enter selection or ESC to previous menu >1
-----
TX power setup
-----
1) 10 mW
2) 20 mW
3) 50 mW
4) 100 mW
5) 200 mW
6) 500 mW
7) 1000 mW

Enter selection or ESC to previous menu >2
-----
Signal threshold setup
-----
Signal threshold -110 dBm

Enter new value (80 - 118) or ESC to previous menu > -90

Enter selection or ESC to previous menu >3
-----
Set TX start delay setup
-----
TX start delay 0 ms

Enter new value (0 - 65535 ms) or ESC to previous menu > 100

```

```
Radio setup
-----
1) TX power level           20 mW
2) Signal threshold level   -90 dBm
3) TX start delay           100 ms
4) Diversity RX             OFF
5) Epic power save          OFF
6) Free channel scan        RX Slave / OFF
7) View hardware info

Enter selection or ESC to previous menu >ESC
```

The maximum useable sensitivity of the receiver is determined by the channel spacing (=radio interface data transfer speed) and also by error correction (utilised or not). For further information see Chapters 3.2, 10.3, 11.1 and 11.2.

In environments with high levels of interference, and when connection distances are short, it is often beneficial to use a "Signal threshold level" value, which is approximately 10 – 20 dBm above the maximum sensitivity level. This will prevent unnecessary receive attempts caused by noise.

#### NOTE !

The setting of the transmitter output power of the radio modem to levels in contradiction with transmitter power levels regulated by local or other governmental authorities is strictly forbidden. Use or intended use of forbidden transmitter power levels may lead to prosecution and penalties. SATEL is not responsible for any illegal use practised with any devices manufactured and/or sold by SATEL and is not liable to pay any damages or compensation caused by such illegal use.

When using SATELLINE-3AS Epic the diversity RX or the power save can be set ON by selecting 4) Diversity RX or 5) Epic power save from the menu.

```
Diversity mode
-----
1) Diversity RX OFF
2) Diversity RX ON

Enter selection or ESC to previous menu >2
```

```
Epic power save
-----
1) OFF
2) ON

Enter selection or ESC to previous menu >2
```

Free channel scan settings can be set by choosing the 6) Free channel scan from the menu. The options are as follows:

```
Free channel scan settings
-----
1) Free scan mode          OFF
2) Type of modem          RX Slave
3) FreeScan net ID        00
4) Rx change freq         500ms
5) Channel hop threshold  -110 dBm
6) Beacon timer           1000 ms
7) Add new frequency to list
8) Show free scan frequency list
9) Clear frequency list

Enter selection or ESC to previous menu >
```

The hardware information can be seen by selecting 7) View hardware information. The menu is as follows:

```
Current hardware info
-----
Product version:         xxxx
Logicboard name:         xxxx
Logicboard version:      xxxx
Radioboard name:         xxxx
Radioboard version:      xxxx
```

### **9.1.3 Changing addressing settings (primary and secondary RX- and TX-addresses)**

Addressing can be switched ON or OFF with the help of main menu selection "3". In the following example a primary RX-address (receiver address) is switched ON and the corresponding hexadecimal address value is modified ("0000" ⇒ "0020"). The current values of the parameters are displayed and changed in toggle-type fashion by selecting the appropriate parameter selection number from the list displayed. The next menu level will then enable the modification of the values (within allowed limits). Modification of all other primary and secondary transmitter and receiver addresses is done in similar way.

```
Enter selection >3

Addressing setup
Toggle ON/OFF values. Current value shown.
-----
1) RX address                OFF
2) TX address                OFF
3) RX address to RS port    OFF
4) Change primary RX address
5) Change primary TX address
6) Change secondary RX address
7) Change secondary TX address
8) TX address autoswitch    OFF

Enter selection or ESC to previous menu >1

Addressing setup
Toggle ON/OFF values. Current value shown.
-----
1) RX address                ON 0000/0000
2) TX address                OFF
3) RX address to RS port    OFF
4) Change primary RX address
5) Change primary TX address
6) Change secondary RX address
7) Change secondary TX address
8) TX address autoswitch    OFF

Enter selection or ESC to previous menu >4

RX address setup
-----
RX Address ON 0000/0000

Enter new address (HEX) or ESC to previous menu >0020
```

The new value is displayed in the menu:

```
RX address setup
-----
RX Address ON 0020/0000

Enter new address (HEX) or ESC to previous menu >ESC
```

The address is given in hexadecimal format with four digits and the number of different addresses is thus over 65 000.

### 9.1.4 Changing serial port settings (Port 1 and Port 2)

The settings of serial port **PORT 1** can be modified by selecting main menu selection "4" and the settings of serial port **PORT 2** by selecting "5". In the following example, PORT 1 will be switched to a non-active state, then the data transfer speed is modified (19200 bit/s  $\Rightarrow$  9600 bit/s), followed by the modification of the number of data bits (8  $\Rightarrow$  7), then the number of parity bits (NONE  $\Rightarrow$  EVEN) and finally the number of stop bits is changed (1  $\Rightarrow$  2).

```
Enter selection >4

Serial port 1
Settings
-----
1) Port status      ON
2) Data speed      19200 bit/s
3) Data bits       8 bit data
4) Parity bits     None parity
5) Stop bits       1 stop bit

Enter selection or ESC to previous menu >1

Serial ports 1 and 2 status setup
-----
1) Port 1 ON / Port 2 OFF
2) Port 1 OFF / Port 2 ON

Enter selection or ESC to previous menu >2

Serial port 1
Settings
-----
1) Port status      OFF
2) Data speed      19200 bit/s
3) Data bits       8 bit data
4) Parity bits     None parity
5) Stop bits       1 stop bit

Enter selection or ESC to previous menu >2

Serial port 1 data speed
-----
1) 300 bit/s
2) 600 bit/s
3) 1200 bit/s
4) 2400 bit/s
5) 4800 bit/s
6) 9600 bit/s
7) 19200 bit/s
8) 38400 bit/s

Enter selection or ESC to previous menu >6
```

Serial port 1  
Settings

- 
- 1) Port status           OFF
  - 2) Data speed           9600 bit/s
  - 3) Data bits            8 bit data
  - 4) Parity bits          None parity
  - 5) Stop bits            1 stop bit

Enter selection or ESC to previous menu >3

Serial port 1 data Bits

- 
- 1) 7 bit data
  - 2) 8 bit data
  - 3) 9 bit data

Enter selection or ESC to previous menu >1

Serial port 1  
Settings

- 
- 1) Port status           OFF
  - 2) Data speed           9600 bit/s
  - 3) Data bits            7 bit data
  - 4) Parity bits          None parity
  - 5) Stop bits            1 stop bit

Enter selection or ESC to previous menu >4

Serial port 1 parity bits

- 
- 1) None parity
  - 2) Even parity
  - 3) Odd parity

Enter selection or ESC to previous menu >3

Serial port 1  
Settings

- 
- 1) Port status           OFF
  - 2) Data speed           9600 bit/s
  - 3) Data bits            7 bit data
  - 4) Parity bits          Odd parity
  - 5) Stop bits            1 stop bit

Enter selection or ESC to previous menu >5

Serial port 1 stop bits

- 
- 1) 1 stop bit
  - 2) 2 stop bits

Enter selection or ESC to previous menu >2

Now all of the modifications of the example have been performed and the new values are displayed:

```
Serial port 1
Settings
-----
1) Port status      OFF
2) Data speed      9600 bit/s
3) Data bits       7 bit data
4) Parity bits     Odd parity
5) Stop bits       2 stop bits

Enter selection or ESC to previous menu >ESC
```

The settings of the serial port must be modified to correspond with the settings of the terminal device that is to be connected to the radio modem. Modification of the settings of serial port **PORT 2** is done according to the principle described above and by first selecting from the main menu selection "5". Additionally, the interface level of Port 2 can be set either to be RS-232, RS-422 or RS-485. See sub-menu below:

```
Serial port 2
Settings
-----
1) Port status      OFF
2) Data speed      9600 bit/s
3) Data bits       8 bit data
4) Parity bits     None parity
5) Stop bits       1 stop bit
6) Interface level  RS-232

Enter selection or ESC to previous menu >6

Serial port 2 Interface setup
-----
1) RS-232
2) RS-485
3) RS-422
```

When installing SATELLINE-3AS(d) or SATELLINE-3AS(d) 869 into SATEL-321, please see chapter 1.5.1 Prepare installation of SATELLINE-3AS(d) modem into the SATEL-321 casing.

**NOTE!**

It should be noted that switching the radio modem into *Programming Mode* by connecting the MODE-pin (pin 12 of the D-connector) to ground (GND) will change the settings of serial port **PORT 1** to "9600,8,N,1" automatically irrespective of the serial port **PORT 1** DATA-mode settings.

### 9.1.5 Modification of handshaking functions

Handshaking related configuration settings can be modified by selecting the options from the main menu "6". In the following example characteristics of the CTS-line (CLEAR TO SEND ⇒ TX BUFFER STATE), CD-line (RSSI-THRESHOLD ⇒ DATA ON CHANNEL) and RTS-line (IGNORED ⇒ FLOW CONTROL) are changed.

```
Enter selection >6

Serial ports 1 and 2 Handshaking
-----
1) CTS line property      Clear to send
2) CD line property       RSSI-threshold
3) RTS line property      Ignored

Enter selection or ESC to previous menu >1

Select CTS line action property
-----
1) Clear to send
2) TX buffer state

Enter selection or ESC to previous menu >2

Serial port 1 and 2 Handshaking
-----
1) CTS line property      TX buffer state
2) CD line property       RSSI-threshold
3) RTS line property      Ignored

Enter selection or ESC to previous menu >2

Select CD line action property
-----
1) RSSI-threshold
2) Data on channel
3) Always ON

Enter selection or ESC to previous menu >2

Serial port 1 and 2 Handshaking
-----
1) CTS line property      TX buffer state
2) CD line property       Data on channel
3) RTS line property      Ignored

Enter selection or ESC to previous menu >3
```



```
Select RTS line action property
-----
1) Ignored
2) Flow control
3) Reception Control

Enter selection or ESC to previous menu >2
```

```
Serial port 1 and 2 Handshaking
-----
1) CTS line property      TX buffer state
2) CD line property       Data on channel
3) RTS line property      Flow control

Enter selection or ESC to previous menu >ESC
```

Now all of the modifications of the example have been performed and the new values are displayed on the menu (see above):

```
-----
***** SATELLINE-3AS *****
SW version x.yz / HW TC4x
-----
Current settings
-----
1) Radio frequency 468.5000 MHz ( CF 468.2000 MHz, spacing 25 kHz )
2) Radio settings  Tx power level 10 mW / Signal threshold -110 dBm / FCS OFF /
TX start delay 0 ms / Diversity RX OFF / EPIC PWRsave OFF
3) Addressing      RX address OFF / TX address OFF /
RX address to RS port OFF / TX address autoswitch OFF
4) Serial port 1   ON / 19200 bit/s / 8 bit data / None parity / 1 stop bit
5) Serial port 2   OFF / 19200 bit/s / 8 bit data / None parity / 1 stop bit
( RS-485/422 )
6) Handshaking    TX buffer state / Data on channel / Flow control
7) Additional setup Error correction OFF / Error check OFF / Repeater OFF /
SL-commands OFF / Priority TX
8) Routing        OFF
9) Tests          OFF
A) Restore factory settings
E) EXIT and save settings
Q) QUIT without saving

Enter selection >
```

### 9.1.6 Special functions

Special functions are modified by selecting from the main menu selection "7". (For further information see the relevant Chapters describing the said functions). The current values of the parameters are displayed and can be modified in toggle-type fashion by choosing the appropriate parameter selection number from the list displayed. The next menu level will then enable the modification of the values (within allowed limits).

```
Enter selection >7
```

```
Additional set-up
```

```
Toggle ON/OFF values. Current value shown.
```

```
-----
```

- |                     |     |
|---------------------|-----|
| 1) Error correction | OFF |
| 2) Error check      | OFF |
| 3) Repeater         | OFF |
| 4) SL-commands      | OFF |
| 5) Priority         | TX  |

```
Enter selection or ESC to previous menu >ESC
```



### 9.1.7 Modification of routing

Configuration settings defining routing can be changed by selecting main menu selection "8".

```
Enter selection >8
```

```
Routing Setup
-----
1) Mode                OFF
2) Protocol
3) Address
4) Net id
5) Route list
6) Route add
7) Route delete
8) Delete all routes

Enter selection or ESC to previous menu >1
```

```
Routing mode setup
-----
1) Disabled
2) Source routing
3) Virtual routing

Enter selection or ESC to previous menu >3
```

```
Routing Setup
-----
1) Mode                Virtual routing
2) Protocol            Userdefined 01 01
3) Address             0009
4) Net id              testnet
5) Route list
6) Route add
7) Route delete
8) Delete all routes

Enter selection or ESC to previous menu >2
```

```
Protocol set-up
-----
1) Userdefined
2) IEC60870-5-101
3) RP570/571

Enter selection or ESC to previous menu >1
```

```
User defined address position setup
-----
1) Start position      01
2) Length              01

Enter selection or ESC to previous menu >1

User defined address start position setup
-----
Current value: 01

Enter new start position (0-16) >02

User defined address start position setup
-----
Current value: 02

Enter new start position (0-16) >ESC

User defined address position setup
-----
1) Start position      02
2) Length              01

Enter selection or ESC to previous menu >2

User defined address length setup
-----
Current value: 01

Enter new length (1-4) >3

User defined address length setup
-----
Current value: 03

Enter new length (1-4) >ESC

User defined address position setup
-----
1) Start position      02
2) Length              03

Enter selection or ESC to previous menu >ESC
```

The display has now returned to the main menu of the routing settings and it can be seen that the routing mode (*Virtual Mode Routing*) as well as the protocol (USERDEFINED 02 03) have been modified.

Following this, a new address will be modified ("0009" ⇒ "0002") and a new Network ID is defined ("testnet" ⇒ "newname"):

```
Routing Setup
-----
1) Mode           Virtual routing
2) Protocol       Userdefined 02 03
3) Address        0009
4) Net id         testnet
5) Route list
6) Route add
7) Route delete
8) Delete all routes

Enter selection or ESC to previous menu >3

Address setup
-----
Current routing address 0009

Enter new address (HEX) or ESC to previous menu >0002

Address setup
-----
Current routing address 0002

Enter new address (HEX) or ESC to previous menu >ESC

Routing Setup
-----
1) Mode           Virtual routing
2) Protocol       Userdefined 01 01
3) Address        0002
4) Net id         testnet
5) Route list
6) Route add
7) Route delete
8) Delete all routes

Enter selection or ESC to previous menu >4

Net id
-----
Net id current value: testnet

Enter net id (8 char) or ESC to previous menu >newname

Net id
-----
Net id current value: newname

Enter net id (8 char) or ESC to previous menu >ESC
```

```
Routing Setup
-----
1) Mode           Virtual routing
2) Protocol       Userdefined 01 01
3) Address        0002
4) Net id         newname
5) Route list
6) Route add
7) Route delete
8) Delete all routes

Enter selection or ESC to previous menu >ESC
```

Selection "5" will produce a list of the routes:

```
Route list
-----
xxx
xxx
xxx

Press any key to return >
```

Selection "6" enables the addition of a route:

```
Route add
-----
Enter destination address (HEX) >
```

Selection "7" enables the removal of a route:

```
Route delete
-----
Enter destination address (HEX) >
```

Selection "8" enables erasure of ALL routing information simultaneously. The menu will then display the following text:

```
Routing Set-up
-----
1) Mode           Virtual routing
2) Protocol       Userdefined 02 03
3) Address        0009
4) Net id         testnet
5) Route list
6) Route add
7) Route delete
8) Delete all routes

Enter selection or ESC to previous menu >8

Do you really want to delete all routes?
Press Y key to delete or ESC to cancel >
```

### 9.1.8 Activating tests

Tests can be activated by selecting main menu selection "9". For more information on tests, see Chapter 5.4. Tests are activated by setting the status of the desired test to "ON" and will remain active until the value of the selection in the menu is returned to the value "OFF".

```
Enter selection >9

Tests setup
-----
1) Short block test      OFF
2) Long block test       OFF

Enter selection or ESC to previous menu >
```

### 9.1.9 Restoring factory settings

Selecting main menu selection "A" can restore factory settings.

```
Enter selection >A

Restore factory settings
-----
Do you want to restore factory settings? (Y/N)>
```

Restoring is confirmed by pressing "Y" (Y=YES) or cancelled by pressing "N" (N=NO). Also the pressing of "ESC" button at any point in the procedure will return the display to the previous (next higher) menu level without restoring factory settings.

### 9.1.10 Saving modified settings into the permanent memory

All modified settings must be saved into the permanent non-volatile memory of the radio modem before switching out of the *Programming Mode*. Selecting the main menu selection "E" automatically saves the settings:

```
Enter selection >E

Configuration saved!
Please turn off program mode switch!
```

**NOTICE!** To switch the radio modem back into *Data Transfer Mode* the MODE-pin of the D-connector (D-15 pin 12) must be disconnected from ground (GND).

### 9.1.11 Updating software

The software of SATELLINE-3AS(d) is stored in a flash memory. If needed the software is easily updated by SaTerm terminal program. Please see the user guide of SaTerm for more details.

## 9.2 Changing parameters using the LCD-display

SATELLINE-3ASd contains a LCD-display that allows modification of the radio modems configuration settings without the use of an external terminal device. This is especially convenient when modifying or re-installing radio modems in the field. The radio modem is switched into *Programming Mode* by pressing the "SET-UP-button ( ■ ). First, the LCD-display will shortly display the model of the radio modem and the software revision information, after which it will automatically display the main menu, which is a list of the modifiable configuration settings.

The main menu is used to select the desired submenus, and the modifications are performed using these submenus. It is possible to jump back at any time to the previous (higher) level in the menu hierarchy by just pressing the "CANCEL"-button (or in some cases the "BACK"-button). Pressing the ▲ or ▼ button modifies parameters with numerical values consisting of digits. Use until the said digit (with the cursor blinking under it) has reached the desired value. In the case of numerical values the "NEXT-button is used to move on to the next digit in the numerical value and then the above described process is used to modify it. The process is repeated until all digits in the value have been edited. Toggle-type parameters (typically with ON/OFF choices modifications have to be confirmed by pressing the "SELECT"- or "SET"-button.

This is the display in *Data Transfer Mode*. Serial port **PORT 1** settings are 19200,N,8,1. Frequency is set to 468,5000 MHz. Signal strength is displayed on the upper left-hand corner and battery level respectively on the upper right corner.

```

ö-102  ä11. 5V
468. 5000 MHz
COM1: 19200N81
Setup
  
```

After pressing the "SET-UP-button the display will shortly show the model of the radio modem and the revision of the software.

```

SATELLINE-3AS
Versi on 3. xx
  
```

The display will automatically then show the main menu, which is a list of modifiable parameters. Pressing the y and p buttons can move the cursor upwards and downwards. When the cursor > is placed beside the desired selection, entry into sub-menu is done by pressing the SELECT-button.

```

>RF frequency
Radio settings
Addressi ng
Port 1
Port 2
Handshaki ng
Addi ti onal
Tests
Factory setup
Contrast

EXIT  yp SELECT
  
```



## 9.2.1 Changing frequency (frequency of the active radio channel)

Press  $\uparrow$  or  $\downarrow$  until the cursor  $>$  points to "RF frequency" – selection and press "SELECT" to move onto the next submenu.

```
>RF frequency
Radio settings
Addressing
Port 1
Port 2
Handshaking
Additional
Tests
Factory setup
Contrast
EXIT   $\uparrow\downarrow$  SELECT
```

Press "CHANGE" if the frequency is to be modified.

```
Active channel
468.5000 MHz
BACK   $\downarrow$  Change
```

**NOTE:** If you want to check possible frequency band limits and the center frequency (factory set values), press  $\blacktriangledown$  and follow instructions given on page 66 (Checking the center frequency).

The cursor  $>$  will now blink under the first digit of the value indicating the center frequency (this first digit cannot be edited). To move onto the next digit, press "NEXT".

```
CF 468.5000 MHz
>468.2000 MHz
^
CANCEL  $\downarrow$  Next
```

Press  $\uparrow$  or  $\downarrow$  until the said digit has reached the desired value. Press "NEXT" to move on to the next digit and repeat the above-described steps.

```
CF 468.5000 MHz
>468.5000 MHz
^
CANCEL  $\uparrow\downarrow$  next
```

Previous steps are repeated four (4) times.

```
:
:
```

Press  $\uparrow$  or  $\downarrow$ , until the last changeable digit has the desired value and confirm changes by pressing "SET".

```
CF 468.5000 MHz
>468.2000 MHz
^
CANCEL  $\uparrow\downarrow$  SET
```

The radio modem will acknowledge changes if they are within acceptable limits ( $\pm 1$  MHz from the center frequency, and within optional band limits) with a similar message as shown on the right (frequency value depends on entered value). The display will return automatically to display the main menu (if the entered frequency is not acceptable an error message will be displayed).

```
Ch accepted
>468.2000 MHz
```

## CHECKING THE CENTER FREQUENCY

Press  $\bar{y}$  or  $\bar{p}$  until the cursor  $>$  points to "RF frequency" selection and then press "SELECT" to move to a submenu which can be used to check (or modify) the frequency.

```
>RF frequency
Radio settings
Addressing
Port 1
Port 2
Handshaking
Additional
Tests
Factory setup
Contrast
EXIT  $\bar{y}\bar{p}$  Select
```

The current active channel frequency setting, is shown in the display. To check other related values press  $\bar{p}$ . (To change the active channel frequencies press "CHANGE").

```
> Active channel
468.5000 MHz
BACK  $\bar{p}$  Change
```

If  $\bar{p}$  was pressed the display will now show the lower and higher limits of frequency **Band 1** (these values cannot be changed). (To change the active channel frequency value press "CHANGE").

```
Band 1 limits
Lo 467.2000 MHz
Hi 469.2000 MHz
BACK  $\bar{y}\bar{p}$  CHANGE
```

By pressing  $\bar{p}$  again the display will show the lower and higher limits of frequency **Band 2** (these values cannot be changed). (To change the active channel frequency value press "CHANGE").

```
Band 2 limits
Lo 467.2000 MHz
Hi 469.2000 MHz
BACK  $\bar{y}\bar{p}$  CHANGE
```

Press  $\bar{p}$  again and the display will return to show the center frequency (this value cannot be changed). (To change the active channel frequency value press "CHANGE").

```
Center freq.
Cf 468.2000 MHz
BACK  $\bar{y}\bar{p}$  CHANGE
```

## 9.2.2 Changing radio settings (transmitter power and receiver sensitivity)

Press  $\bar{y}$  or  $\bar{p}$  until the cursor  $>$  points to "Radio settings" selection and press "SELECT" to move on to the submenu.

```
RF frequency
>Radio settings
Addressing
Port 1
Port 2
Handshaking
Additional
Tests
Factory setup
Contrast
EXIT   $\bar{y}\bar{p}$  SELECT
```

Press  $\bar{y}$  or  $\bar{p}$  until the cursor  $>$  points to the setting to be modified and press "CHANGE".

```
>TX level
Sig. Threshold
TX start delay
Diversity RX
Epic power save
BACK   $\bar{p}$  Change
```

### MODIFYING TRANSMITTER OUTPUT POWER:

The displayed list consists off all possible values of transmitter output power. Press  $\bar{y}$  or  $\bar{p}$  until the cursor  $>$  points to the desired value and press "SET".

**NOTE:** The starting position of the cursor indicates the previously set value.

```
>10mW
20mW
50mW
100mW
200mW
500mW
1000mW
CANCEL  $\bar{p}$  SET
```

### MODIFYING RECEIVER SENSITIVITY:

The displayed list consists off all possible values of receiver sensitivity. Press  $\bar{y}$  or  $\bar{p}$  until the cursor  $>$  points to the desired value and press "SET".

**NOTE:** The starting position of the cursor indicates the previously set value.

```
mi n
>-118 dBm
-117 dBm
.
.
-81 dBm
-80 dBm
max
CANCEL  $\bar{y}\bar{p}$  SET
```

### MODIFYING THE TRANSMIT START

#### DELAY:

The display will show the current value of the delay. Press "SET" to modify the value.

Press  $\bar{y}$  or  $\bar{p}$  until the first digit of the value has reached the desired value and then press "NEXT" to move on to the next digit.

Repeat the above described five (5) times.

Press  $\bar{y}$  or  $\bar{p}$  until the last changeable digit has the desired value and finally confirm changes by pressing "SET".

```
TX start delay
Current value:
0 ms
CANCEL  $\bar{y}\bar{p}$  SET
```

```
TX start delay
>00000
^
CANCEL  $\bar{y}\bar{p}$  Next
```

⋮

```
TX start delay
>01234
^
CANCEL  $\bar{y}\bar{p}$  SET
```

Please note with SATELLINE-3AS Epic the output power alternatives are as follows: 1, 2, 5 and 10 W. Selections Diversity RX and Epic power save are possible to set ON only with Epic modems.

### 9.2.3 Changing addressing

Press  $\bar{y}$  or  $\bar{p}$  until the cursor  $>$  points to "Addressing" selection and press "SET-UP" to move on to the submenu.

```
RF frequency
Radio settings
>Addressing
Port 1
Port 2
Additional
Test
Factory setup
Contrast
EXIT  $\bar{y}\bar{p}$  Set up
```

Select the desired submenu (RX or TX address) by pressing  $\bar{y}$  or  $\bar{p}$  and finally press "CHANGE".

```
>RX addr OFF
TX addr OFF
RX addr->RS OFF
TX add auto OFF
BACK  $\bar{p}$  Change
```

Press  $\bar{y}$  or  $\bar{p}$  until the first digit of the address has reached the desired value and move on to the next digit by pressing "NEXT".

```
RX address
>0000 0000 OFF
^
CANCEL  $\bar{y}\bar{p}$  Next
```

Repeat the above described eight (8) times.

:  
:

Press NEXT again to jump to the toggle field (ON/OFF) and change the status to the desired value by pressing  $\bar{y}$  and  $\bar{p}$  until correct status is reached. Confirm the new address and status (ON/OFF state) by pressing "SET". The display will return to the previous (higher) level submenu.

```
RX Address
>0123 0123 ON
^
CANCEL  $\bar{y}\bar{p}$  SET
```

**NOTE:** Both RX and TX address modifications are done in the same way described above.

## 9.2.4 Changing serial port settings (Port 1 and Port 2)

Press **y** or **p** until the cursor **>** points to the desired port (in this example to **Port 1**) and move on to the submenu by pressing "SELECT".

```
RF frequency
Radio settings
Addressing
>Port 1
Port 2
Handshaking
Additional
Tests
Factory setup
Contrast
EXIT yþ SELECT
```

Press **y** or **p** until the cursor **>** points to the setting to be modified and then press "CHANGE".

```
>ON
19200 bit/s
8 bit data
None parity
1 stop bit
BACK yþ Change
```

### MODIFICATION OF PORT STATUS:

Press **y** or **p** until the cursor **>** points to the desired port status. Confirm selection by pressing "SET". The display will return to the previous (higher) level submenu.

**NOTICE:** The starting position of the cursor indicates the previously set value.

```
>P1 ON / P2 OFF
P1 OFF / P2 ON

CANCEL yþ SET
```

### MODIFICATION OF DATA TRANSFER SPEED:

Press **y** or **p** until the cursor **>** points to the desired data transfer speed value (X bit/s). Confirm the selection by pressing "SET". The display will return to the previous (higher) level submenu.

**NOTE:** The starting position of the cursor indicates the previously set value.

```
300 bit/s
600 bit/s
1200 bit/s
2400 bit/s
4800 bit/s
9600 bit/s
>19200 bit/s
38400 bit/s
CANCEL yþ SET
```

### MODIFICATION OF THE NUMBER OF DATA BITS:

Press **y** or **p** until the cursor **>** points to the desired number of data bits (7 or 8 or 9 bit data length). Confirm the selection by pressing "SET". The display will return to the previous (higher) level submenu.

**NOTE:** The starting position of the cursor indicates the previously set value.

```
7 bit data
>8 bit data
9 bit data
CANCEL yþ SET
```

### MODIFICATION OF PARITY BITS:

Press **y** and **p** until the cursor **>** points to the desired parity bit status. Confirm the selection by pressing "SET". The display will return to the previous (higher) level submenu.

**NOTE 1:** The starting position of the cursor indicates the previously set value.

**NOTE 2:** If the number of data bits is set to 9, the value of parity bits must be set to NONE (no parity).

```
>None parity
Even parity
Odd parity
CANCEL yþ SET
```

**MODIFICATION OF THE NUMBER OF STOP BITS:**

Press  $\bar{y}$  or  $\bar{p}$  until the cursor  $>$  points to the desired number of STOP bits. Confirm selection by pressing "SET". The display will return to the previous (higher) level submenu.

**NOTE:** The starting position of the cursor indicates the previously set value.

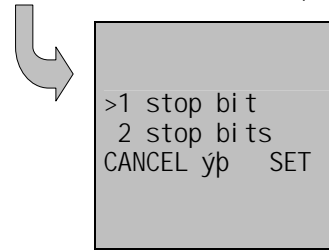

**NOTE:** Port 2 settings are modified correspondingly.

**9.2.5 Modification of handshaking functions**

Press  $\bar{y}$  or  $\bar{p}$  until the cursor  $>$  points to "Handshaking" selection and move on to the submenu by pressing "SELECT".

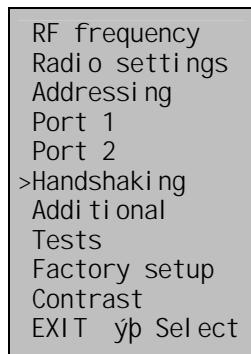

There are three (3) submenus relating to handshaking parameters. Press  $\bar{y}$  and  $\bar{p}$  until the cursor  $>$  points to the desired submenu selection and press "CHANGE".

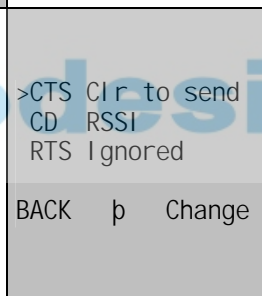

**DEFINING CTS-LINE FUNCTIONS:**

Press  $\bar{y}$  and  $\bar{p}$  until the desired function is indicated by the cursor  $>$  and confirm selection by pressing "SET". The display will return to the previous (higher) level submenu.

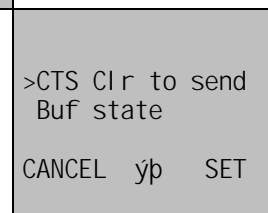

**DEFINING CD-LINE FUNCTION:**

Press  $\bar{y}$  and  $\bar{p}$  until the desired function is indicated by the cursor  $>$  and confirm selection by pressing "SET". The display will return to the previous (higher) level submenu.

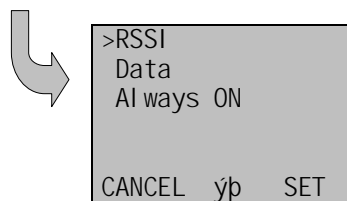

**DEFINING RTS-LINE STATUS:**

Press  $\bar{y}$  and  $\bar{p}$  until the desired function is indicated by the cursor  $>$  and confirm selection by pressing "SET". The display will return to the previous (higher) level submenu.

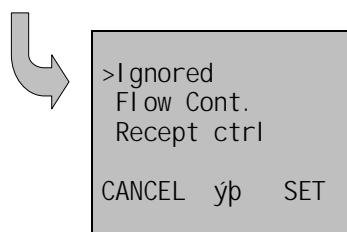

### 9.2.6 Selecting special functions

Press  $\uparrow$  or  $\downarrow$  until the cursor  $>$  points to "Additional" selection and press "SELECT" to move on to the submenu.

```
RF frequency
Radio settings
Addressing
Port 1
Port 2
>Additional
Test
Factory setup
Contrast
EXIT  $\uparrow\downarrow$  Select
```

Press  $\uparrow$  or  $\downarrow$  until the cursor  $>$  points to the setting to be modified. Press "CHANGE" to toggle the status of the said parameter from "ON" to "OFF" and vice versa. Press "CHANGE" until the parameter has the desired status. Repeat for all special functions to be modified and finally confirm all changes by pressing "BACK". The display will return to the previous (higher) level submenu.

```
>Error corr. OFF
Error check OFF
Repeater OFF
SL-commands OFF
Priority TX

BACK  $\uparrow\downarrow$  Change
```



### 9.2.7 Activating tests

Press  $\uparrow$  or  $\downarrow$  until cursor  $>$  points to "Tests" selection and press "SELECT" to move on to the submenu.

```
RF frequency
Radio settings
Addressing
Port 1
Port 2
Handshaking
Additional
>Tests
Factory set-up
Contrast
EXIT  $\uparrow\downarrow$  Select
```

Press  $\uparrow$  or  $\downarrow$  until cursor  $>$  points to the test that is to be initiated. Press "CHANGE" to toggle the status of the selected test from "ON" to "OFF" and vice versa. Press "CHANGE" until the parameter has the desired status. After the tests have been set to desired states confirm all changes by pressing "BACK". The display will return to the previous (higher) level submenu.

```
>Short Block OFF
Long Block OFF
BACK  $\uparrow\downarrow$  Change
```

### 9.2.8 Restoring factory settings

Press  $\uparrow$  or  $\downarrow$  to move cursor  $>$  to point to "Factory set-up" selection and press "SELECT" to move on to the submenu.

```
RF frequency
Radio settings
Addressing
Port 1
Port 2
Additional
Test
>Factory setup
Contrast
CANCEL  $\uparrow\downarrow$  Select
```

Press "YES" and all radio modem configuration settings will return to factory settings.  
**NOTE:** The display will show the question two (2) times to make sure that restoring factory settings is actually intended.

```
Do you want to
restore factory
settings?
NO      YES
```

### 9.2.9 Adjusting the contrast of the LCD-display

Press  $\uparrow$  or  $\downarrow$  to move the cursor  $>$  to point to "Contrast" selection and press "SELECT" to move on to the submenu.

```
RF frequency
Radio settings
Addressing
Port 1
Port 2
Additional
Test
Factory set-up
>Contrast
CANCEL  $\uparrow\downarrow$  Select
```

The display will show the current value of contrast. To modify contrast setting press "CHANGE".

```
Display contr. 3
BACK  Change
```

Press  $\uparrow$  or  $\downarrow$  until the cursor  $>$  points to the desired contrast level value. Confirm selection by pressing "SET". The display will return to the previous (higher) level submenu.

**NOTE:** The modified contrast value will actually take effect only after the radio modem is switched out from *Programming Mode* back into *Data Transfer Mode*.

**NOTE:** The starting position of the cursor indicates the previously set value.

```
1
2
>3
4
5

CANCEL  $\uparrow\downarrow$  SET
```



### 9.2.10 Saving modified values into the internal memory

After all desired modifications have been performed; they have to be saved in order to make them permanent (until next modification). This is accomplished by choosing selection "EXIT" from the main menu. The display will then show a message (see below) asking a confirmation of the performed modifications.

By choosing "YES" all modifications are saved into the non-volatile memory inside the radio modem. By choosing "NO" all modification performed are cancelled and previous settings remaining in the non-volatile memory.

Press "YES" to save all modifications into the non-volatile memory and "NO", if modifications are to be cancelled.

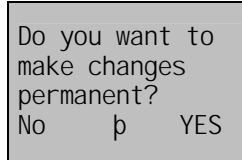

## 9.3 Changing parameters using the SL-COMMANDS

The controlling terminal device can change the configuration settings of a radio modem. This is accomplished with the help of SL-commands, which can be used during data transfer. SL-commands can be used to change e.g. the frequency or addresses. It is also possible to interrogate a radio modem in order to gain information concerning current settings that are in use. The terminal device is either a PC or a programmable logic (PLC) together with suitable (terminal) program. SL-commands must be enabled using *Programming Mode* before they can be used.

An SL-command is a one continuous string of characters, which is separated from other data by pauses that are at least three (3) characters long. No extra characters are allowed at the end of an SL-command. Serial interface settings are the same as in data transfer and pin 12 of the serial connector **MUST NOT** be connected to ground (GND). SL-command is properly recognised also in the case when the command string is terminated in <CR> (=ASCII character no. 13, Carriage Return, 0x0d) or <CR><LF> (<LF> = ASCII char. no. 10, Line Feed, 0x0a). If multiple SL commands are sent to the radio modem the next command can be given after receiving the response ("Ok" or "Error") of the proceeding command. In addition, it is recommended to implement a timeout to the terminal software for recovering the case when no response is received from the radio modem.

When the power of a radio modem is switched off the configuration settings of a radio modem always return to values defined initially using the *Programming Mode*, thus resetting any settings changed using SL-commands during power on. It is however possible to save settings changed by using SL-commands and to make them the new configuration settings.

The radio modem will acknowledge all commands by returning an "OK" (command carried out or accepted) or the requested value, or an "ERROR" (command not carried out or interpreted as erroneous) message.

In case you need more information on the time delays related to the use of SL-commands, please contact the manufacturer.

### 9.3.1 Frequency

Command	Effect and description of command
SL&F=nnn.nnnnn	Set frequency to nnn.nnnnn MHz
SL&F?	Display current frequency (response 'nnn.nnnnn MHz')
SL&C?	Display center frequency (response 'nnn.nnnnn MHz')
SL&+=nn	Set frequency nn channels above center frequency Frequency = Center frequency + nn * Channel spacing, where nn=[0...Number of channels/2]
SL&-=nn	Set frequency nn channels below center frequency Frequency = Center frequency – nn * Channel spacing, where nn=[0...Number of channels/2]
SL&N?	Display current frequency deviation from center frequency as channels (Frequency – Center frequency)/Channel spacing (response '+nn' or '-nn')
SL&D=x	Sets the operational mode of the radio. The different values of x are: "S" = Single Channel "D" = Dual Channel "R" = Reverse Dual Channel <b>Note!</b> Use this command only, if the setup of the frequency bands matches the Dual Channel operation.
SL&D?	Request the operational mode of the radio. The response is one of the following: "S" = Single Channel "D" = Dual Channel "R" = Reverse Dual Channel <b>Note!</b> Use this command only, if the setup of the frequency bands matches the Dual Channel operation.

### 9.3.2 Addressing

xxxx = address in hexadecimal format (0000 ... FFFF)

Command	Effect and description of command
SL#I=xxxx	Set all addresses (RX1, RX2, TX1, TX2) to value xxxx
SL#I?	Display both primary addresses (TX1, RX1) (response 'xxxx;yyyy')
SL#T=xxxx	Set both transmit addresses (TX1, TX2) to value xxxx
SL#T?	Display primary transmit address (TX1) (response 'xxxx')
SL#R=xxxx	Set both receive addresses (RX1, RX2) to value xxxx
SL#R?	Display primary receive address (RX1) (response 'xxxx')
SL#P=xxxx;yyyy	Set primary transmit address (TX1) to value xxxx and receive address (RX1) to value yyyy
SL#S=xxxx;yyyy	Set secondary transmit address (TX2) to value xxxx and receive address (RX2) to value yyyy
SL#P?	Display primary transmit address (TX1) and receive address (RX1) (response 'xxxx;yyyy')
SL#S?	Display secondary transmit address (TX2) and receive address (RX2) (response 'xxxx;yyyy')

### 9.3.3 Radio parameters

Command	Effect and description of command
SL@R?	Display field strength of the last received message (the value is an average of many measurements made during the same reception). Response "-xx dBm", where xx is a decimal value of the field strength and it is between -80 dBm and -118 dBm. Value available 7s after reception. SATELLINE-3AS Epic returns the stronger value of two receivers.
SL@P=xxxx	Set the RF output power, where xxxx is the decimal value of the intended power in milliwatts. If the given value does not correspond to one of the programmed power levels, the output power is set to the nearest possible value.
SL@P?	Requests the RF output power. Response "xxxx mW", where xxxx is a decimal value the output power of the transmitter.
SL@T=-xxx	Set the minimum power level of the signal to be received (= "Signal Treshold level), where xxx is a decimal value of the new intended level in dBm.
SL@T?	Request of the current "Signal Treshold Level". Response is "-xxx dBm.

### 9.3.4 Other functions

Command	Effect and description of command
SL**>	Save current settings as permanent settings
SL%V?	Display software revision information (response 'Vn.nn')
SL+P=xx	Get the measured signal strength from the remote modem i.e. SL "ping". If a remote radio modem is pinged the response is "OK, Modem xxxx rssi -80 dBm", where xxxx=RX1/RX2 address (in case the Tx/Rx addressing is configured) or the terminal address of the modem ( in case the Message Routing is ON). "OK" is first received from the current radio modem to acknowledge that the SL-ping command has been interpreted correctly. The rest of the response will take a little longer to come, depending on the length of the radio link. The remote radio modem that is to be pinged does not need to have SL-commands ON. The value of the RSSI is between -118 and -80 dBm. If the signal strength is better than -80 dBm, -80 dBm is shown. If the current radio modem is pinged, the response is "Local OK". Please note that the SL-ping message will come out from the serial line of the radio modem that is pinged and also the repeater stations using the Tx/Rx addressing. Note, SL-ping is a very short message so it may not give accurate results from the link condition. Even if the responses are good, channel interference may cause problems with longer data messages.

### 9.3.5 **SATELLINE-2ASxE compatible SL-commands**

The commands listed in the table below are included only to ensure compatibility and their use is not recommended in new networks. The commands do not need a CR-character (carriage return) at the end of the command string.

Command	Effect and description of command
SLHxx	Set frequency xx channels above center frequency. Frequency = Center frequency + xx*Channel spacing, where xx=[00...99]
SLLxx	Set frequency xx channels below center frequency. Frequency = Center frequency - xx*Channel spacing, where xx=[00...99]
SLAxx	Set all addresses (RX1, RX2, TX1, TX2) to value xx, where xx=[00h...FFh]
SLTxx	Set both transmit addresses (TX1, TX2) to value xx, where xx=[00h...FFh]
SLRxx	Set both receive addresses (RX1, RX2) to value xx, where xx=[00h...FFh]
SLSOS	Save current settings as permanent settings



## 10 INSTALLATION

### 10.1 Installation of a Radio Data Modem

The radio modem should be installed with the installation accessories supplied with the radio modem. There is also available an installation component for mounting the radio modem to a DIN-rail.

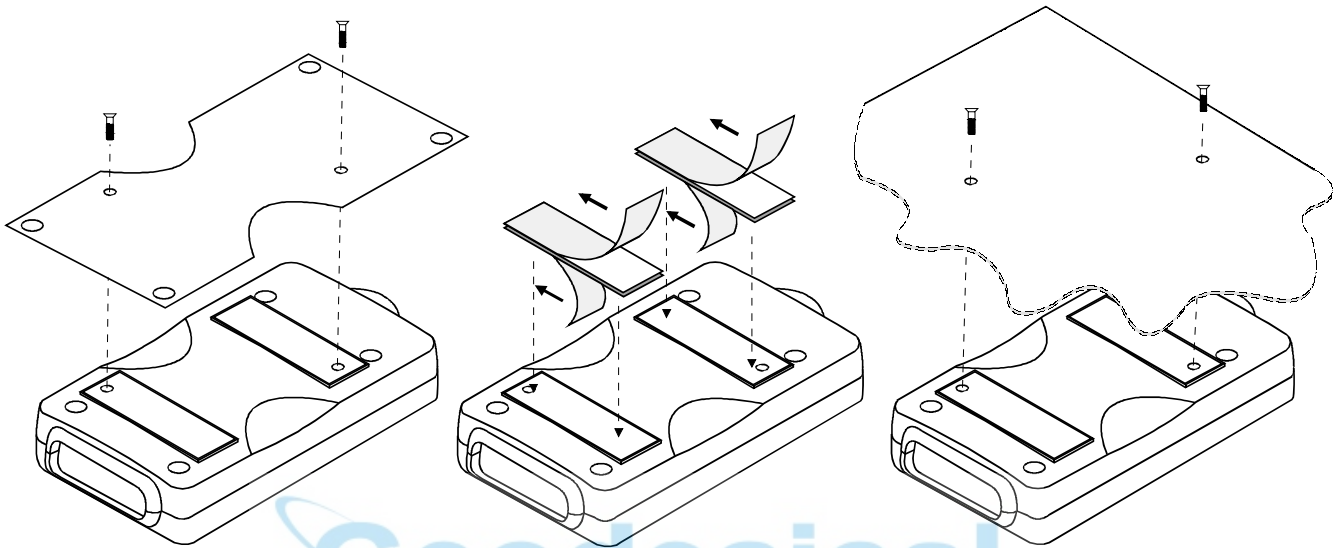

1. Installation with the installation plate supplied with the radio modem. The installation plate is fastened to the backside of the radio modem.

The installation plate can be mounted using the holes provided on the plate.

2. Installation using the Velcro-tape provided with the radio modem.

3. Installation can also be made directly to customer's equipment.

#### NOTE!

When selecting a suitable location for the radio modem it must be ensured that no water can get into the radio modem under any conditions. Direct sunlight is also to be avoided. It is not recommendable to install the radio modem on a strongly vibrating surface. Suitable dampening and/or isolation materials should be used in cases where the installation surface will be subjected to vibration.

## 10.2 Connection cables

### NOTE!

When installing the cables of the serial interface, the operating voltage of all devices must be off (POWER OFF condition).

Due to the greater current consumption of SATELLINE-3AS Epic operating voltage must be connected to pins 14 AND 15, and ground to pins 7 AND 8. Correct fuse rating is in this case 4 A (SLOW FUSE).

### 10.2.1 RS-232 wiring

Basic RS-232 connection between the radio modem (PORT1) and a typical PC (COM-port):

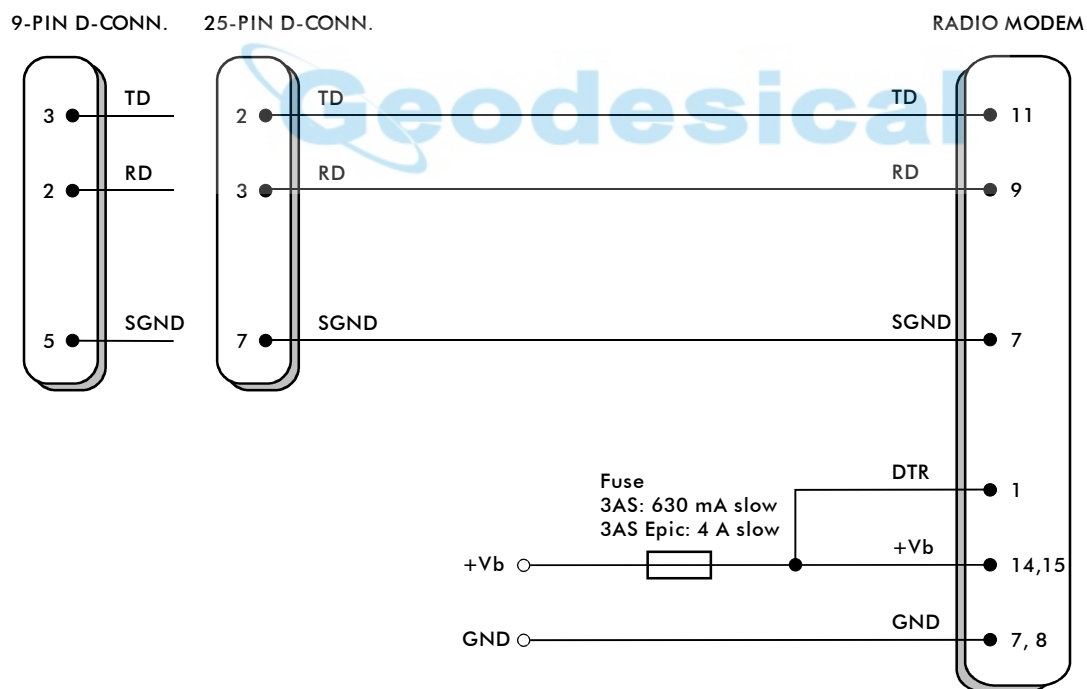

**NOTE THE WIRING ON THE DIAGRAM ABOVE!** The maximum voltage level at DTR pin is +25 Vdc. In case the operating voltage is greater, user must take care that the voltage at DTR pin does not exceed +25 Vdc e.g. by using a resistive divider.

Basic RS-232 connection between the radio modem (PORT1) and a typical PC (COM-port) using handshaking:

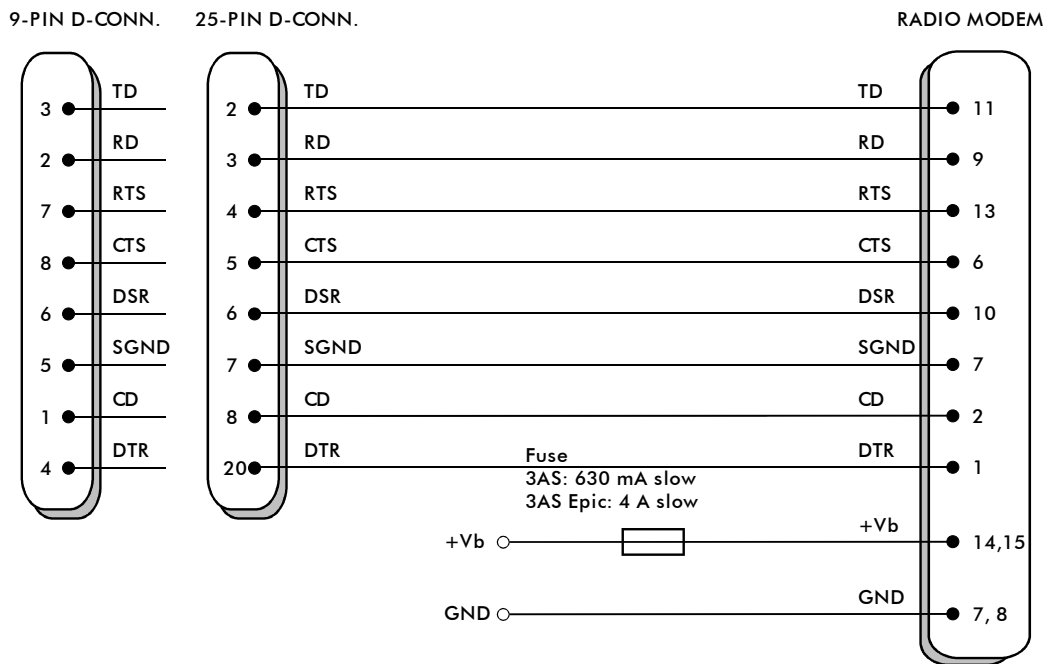

RS-232 connection between a radio modem (PORT2 in RS-232 mode) and a typical PC (COM-port):

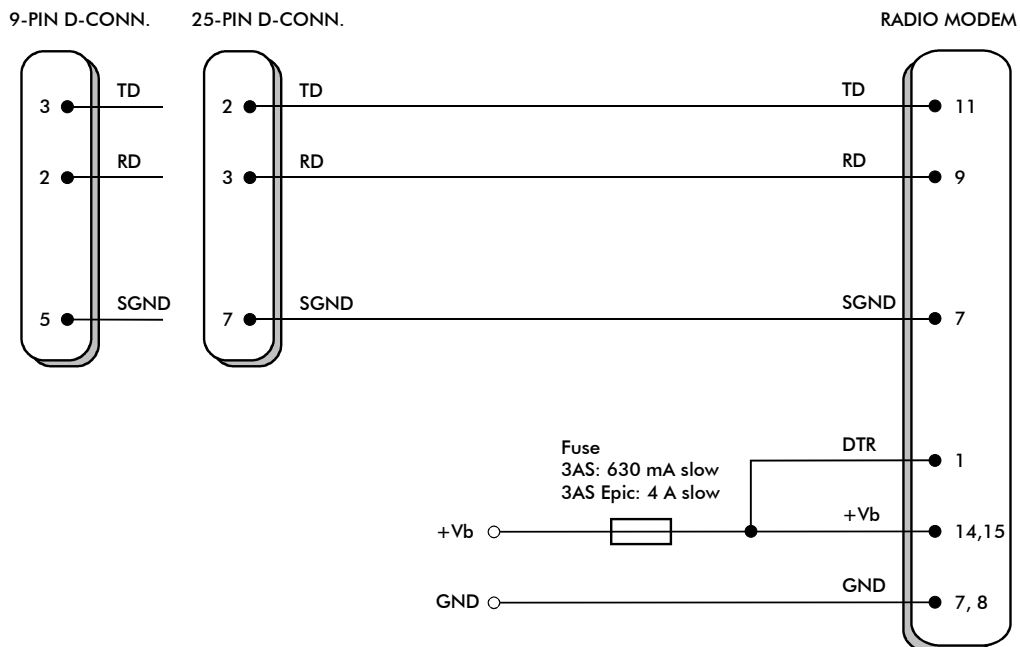

**NOTE THE WIRINGS ON THE DIAGRAMS ABOVE!** The maximum voltage level at DTR pin is +25 Vdc. In case the operating voltage is greater, user must take care that the voltage at DTR pin does not exceed +25 Vdc e.g. by using a resistive divider.

### 10.2.2 RS-422 wiring

PORT2 RS-422 connection:

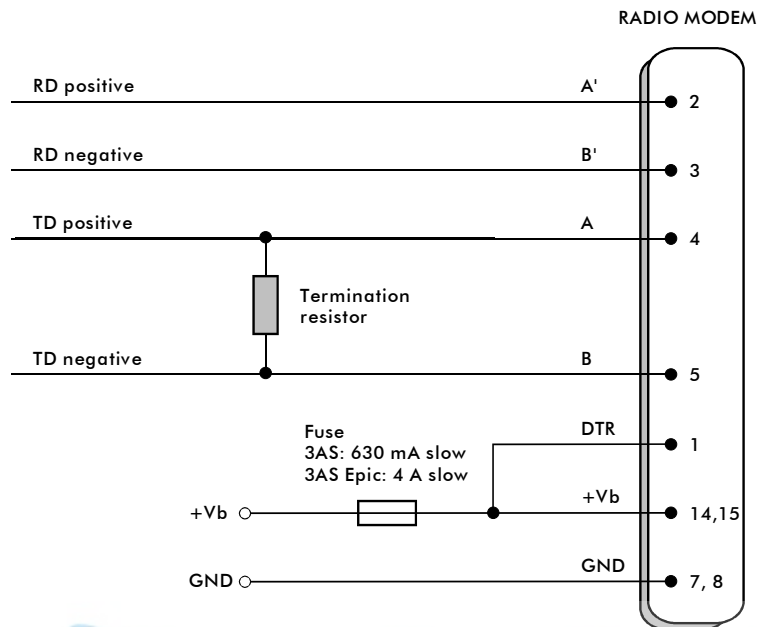

If the transmission lines are long the receiving end of the lines must be terminated using a separate termination resistor (typical values range from 100 -120  $\Omega$  depending on the characteristic impedance of the transmission line).

**NOTE THE WIRING ON THE DIAGRAM ABOVE!** The maximum voltage level at DTR pin is +25 Vdc. In case the operating voltage is greater, user must take care that the voltage at DTR pin does not exceed +25 Vdc e.g. by using a resistive divider.



### 10.2.3 RS-485 wiring

#### PORT2 RS-485 connection:

Both ends of the transmission line must be terminated by connecting a separate terminating resistor between the positive and negative signal wire. Typical values range from 100 – 120  $\Omega$  depending on the characteristic impedance of the line.

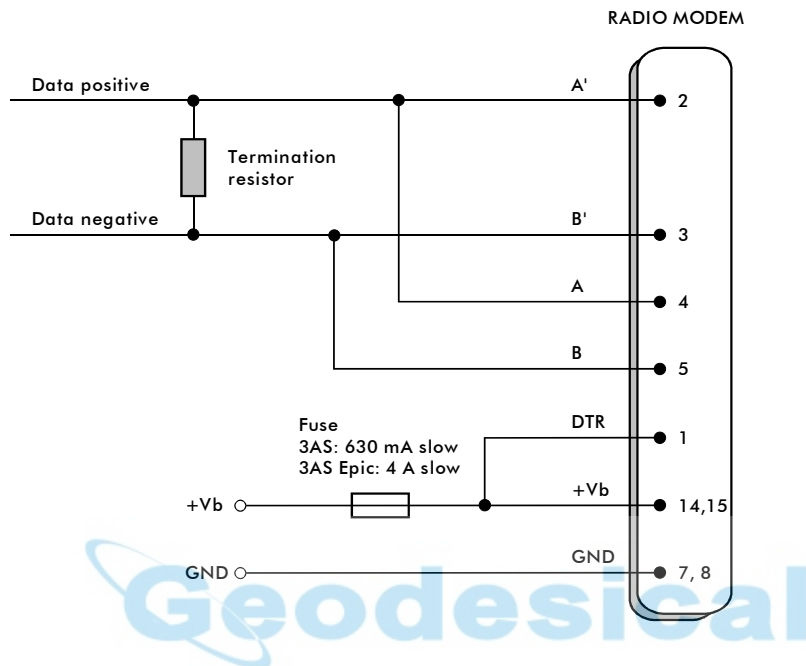

#### Connection to Profibus device

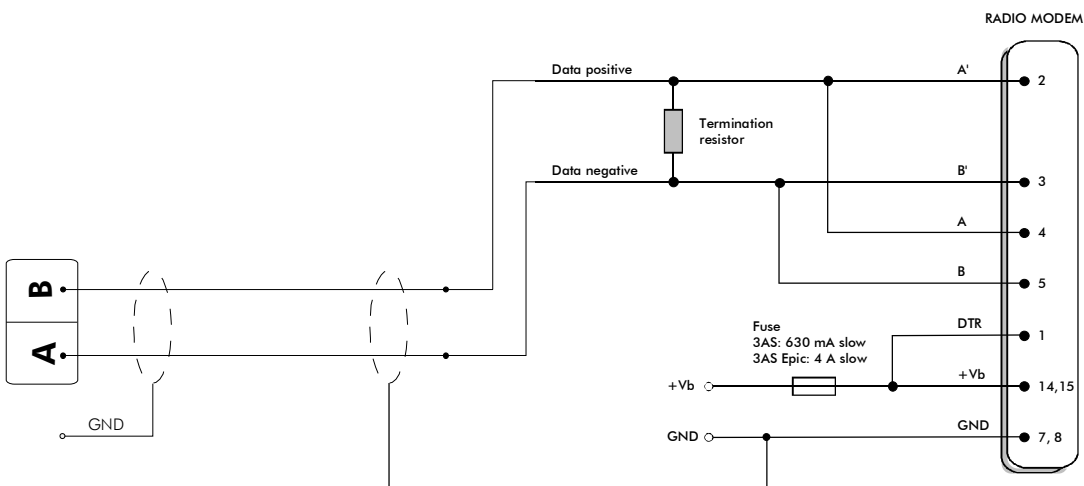

**NOTE THE WIRINGS ON THE DIAGRAMS ABOVE!** The maximum voltage level at DTR pin is +25 Vdc. In case the operating voltage is greater, user must take care that the voltage at DTR pin does not exceed +25 Vdc e.g. by using a resistive divider.

#### 10.2.4 **Fuse**

A proper fuse must be connected in between the radio modem and the power supply. The correct value depends on the model (see list below).

	Fuse
SATELLINE-3AS(d)	630 mA slow
SATELLINE-3AS(d) 869	630 mA slow
SATELLINE-3AS(d) Epic	4 A slow

#### 10.2.5 **Power supply**

The allowed operating voltage is  $+9 \dots +30 V_{DC}$ . (SATELLINE-3AS Epic  $+11.8 \dots +30 V_{DC}$ ). The radio modem must only be connected to a power supply with an adequate current output (power rating minimum is 10W, with the Epic-model 50W). The pins 15 and 14 of the D-connector are connected to the positive power supply line. The pins 8 and 7 of the D-connector are connected to negative power supply line (ground).

The DTR-line of the radio modem, which is connected to pin 1, can be used as an ON/STANDBY –switch, and in this way the radio modem can be switched either ON (operational state) or OFF (STANDBY). The logical state "1" (more than +3 V) of the DTR-line corresponds to ON-state and a logical state "0" (0 V ... -15 V) corresponds to a STANDBY state.

In applications, where the radio modem is used as a portable device (meaning battery operation), the DTR-line (pin 1) should be connected to a logical state "0" always when it is possible to conserve battery power and prolong operational time between battery charging.

NOTE! There is a galvanic connection between signal ground (SGND, pin 7), ground (GND, pin 8), outer conductor of antenna connector and modem casing.

## **10.3 Antenna installation**

### **NOTE!**

Because of the great transmission power of SATELLINE-3AS Epic radio modem, only an external antenna is allowed. A whip-antenna directly connected to the antenna connector must not be used.

### **10.3.1 Hand-held equipment**

- $\frac{1}{4}$ -wave antenna (wavelength at frequency of 450 MHz is approximately 70 cm)
- Helix-antenna

Antennas are installed directly to the TNC-type antenna connector at the upper part of the radio modem.

### **10.3.2 Mobile equipment**

- $\frac{1}{4}$ -wave antenna
- $\frac{1}{2}$ -wave antenna

The ideal installation position is vertical, and there should be at least 0.5 m of free space around the antenna. In small systems a  $\frac{1}{4}$ -wave antenna is sufficient. A separate ground plane should be placed under the antenna (vehicle rooftop or the engine hood or trunk door are usually suitable). In problematic cases the most suitable type is a  $\frac{1}{2}$ -wave antenna. It can be installed directly at the top of a pipe with the added benefit of gaining as much as free space around the antenna as possible. In cases which the antenna cannot be directly connected to the TNC-connector of the radio modem, a coaxial cable with 50  $\Omega$  impedance must be used between the antenna and the TNC-connector.

### **10.3.3 Base stations**

- Omni-directional antennas ( $\frac{1}{4}$ - ,  $\frac{1}{2}$ - or  $\frac{5}{8}$ -wave antenna)
- directional antennas (yagi /multi-element antenna or corner antenna)

The antenna should be installed in a vertical position. The exact location of the antenna depends on several factors, such as the size of the overall system and the coverage area terrain contours. A rule of thumb is that the base station antenna should be located at the highest point of the coverage area and as close to the centre of the coverage area as possible. The base station antenna can also be located inside a building, if the walls of the building do not contain metal.

### **10.3.4 General antenna installation instructions**

The reliability and the achievable coverage of useful signal strength can be severely affected by the positioning of the antenna. Antenna and cable connectors should have gold-plated pins and sockets, as use of low quality connectors can lead to eventual oxidation of the connector surfaces which in turn may degrade the contact and cause additional attenuation. Good quality tools and materials must be used when installing radio modems, antennas and cables. The weather tolerance of the materials used must also be taken into account. Installed materials must withstand all foreseeable weather conditions (frost, excess sun, direct UV-radiation, seawater etc.). Also possible environmental pollution must be considered (acids, ozone etc.).

Antennas must be installed well away from metallic objects. In the case of small antennas this distance should be at least  $\frac{1}{2}$  m. With large antennas the distance should be  $>5$  m and in case of repeater antenna combinations  $>10$  m.

If the system contains a large number of radio modems, the best location for an antenna is the highest point of a building and possibly an additional antenna mast. If a separate antenna mast is used, the antenna can, if necessary, be installed sideways about 2...3 m from the mast itself.

When installing an antenna possible interference sources must be considered. Such interference sources are, for example:

- mobile telephone network base station antennas
- public telephone network base station antennas
- television broadcast antennas
- radio relay antennas
- other radio modem systems
- PC-related devices (approximately 5 m radius from antenna)

When ordering antennas we request you to note that antennas are always tuned to a specific frequency range. Simple antennas and antennas, which have been constructed of stacked yagi-antennas, are typically rather broadband. As the number of yagi-elements increases the frequency range becomes narrower.

When designing and installing a system it is advisable to prepare to test the system, and also to consider serviceability of the system. In particular cabling should be planned to allow easy access and to allow for maintenance. It is often practical to use long antenna cables, so that the radio modem can be installed far enough from the antenna itself to a location that is easily accessible (see section 10).

The type of the antenna cable is dependent on the length of the antenna cable, and the following table can be used to select a suitable type:

Length	Type	Attenuation 10m/450MHz
<5m	RG58	3.0dB
0...20m	RG213	1.5dB
>20m	NK Cable RFF 1/2"-50	0.7dB
>20m	AirCom+	0.8dB*

\*) AirCom+ cable is partially air insulated, so the use of this cable requires that the connection between the cable and the connectors are fully airtight.

If there is a line-of-sight path between the antennas a 6 dB power marginal is usually adequate. However, if the connection is built on the reflection and/or the knife-edge diffraction the path loss can vary even 20 dB depending on the weather conditions. In this case a short test can give a too positive result of the quality of the connection. Thus the height of the antennas and topographical obstacles must be surveyed with great care. From time to time a marginal connection can be used if the data transmission protocol is well prepared for this and the data transmission that occasionally slows down does not cause any problems to the system.

Vertical polarised antennas (antenna elements are in vertical position) are often used in radio systems. In a system between a base station and substations vertical polarisation is recommended. The radio modem antenna can not be mounted on the same level as the other substation antennas in the same building. The best way to distinguish from the other antennas situated in the neighbourhood is to mount the antennas as far a part as possible from each other on the altitude level. The best result is generally obtained when all the antennas are in the same mast. With an extra ground plane between the antennas more distinction can be obtained between the antennas in the mast.

Horizontal polarisation can be used in data transmission between two points. With the polarisation attenuation more distinction is obtained to vertical polarised systems. The influence of the directional patterns of the antennas must, however, be taken into consideration. If a distinction to another interfering antenna is wanted with the horizontal polarised antennas there must be a good attenuation of the back lobe. In addition to this the interfering radiator should be situated behind the antenna.

When a system does not demand the use of an omni-directional antenna it is recommended that directional antennas are used e.g. two-element yagis in permanent external installations. Please note that as antenna amplification increases the setting of the direction of the antenna requires more attention.

Base stations in high places should be supplied with high-Q cavity filters. Please note that the higher the base station antenna, the larger the coverage area and in turn that the risk of interference is also increased.

SATEL recommends the use of a band-pass filter with a large Q in the antenna cable of the base station.

**Example of an antenna installation:** by using amplifying antennas ( $G$ =Gain) and by installing the antenna high, long connection distances can be realised using the SATELLINE-3AS radio modem.

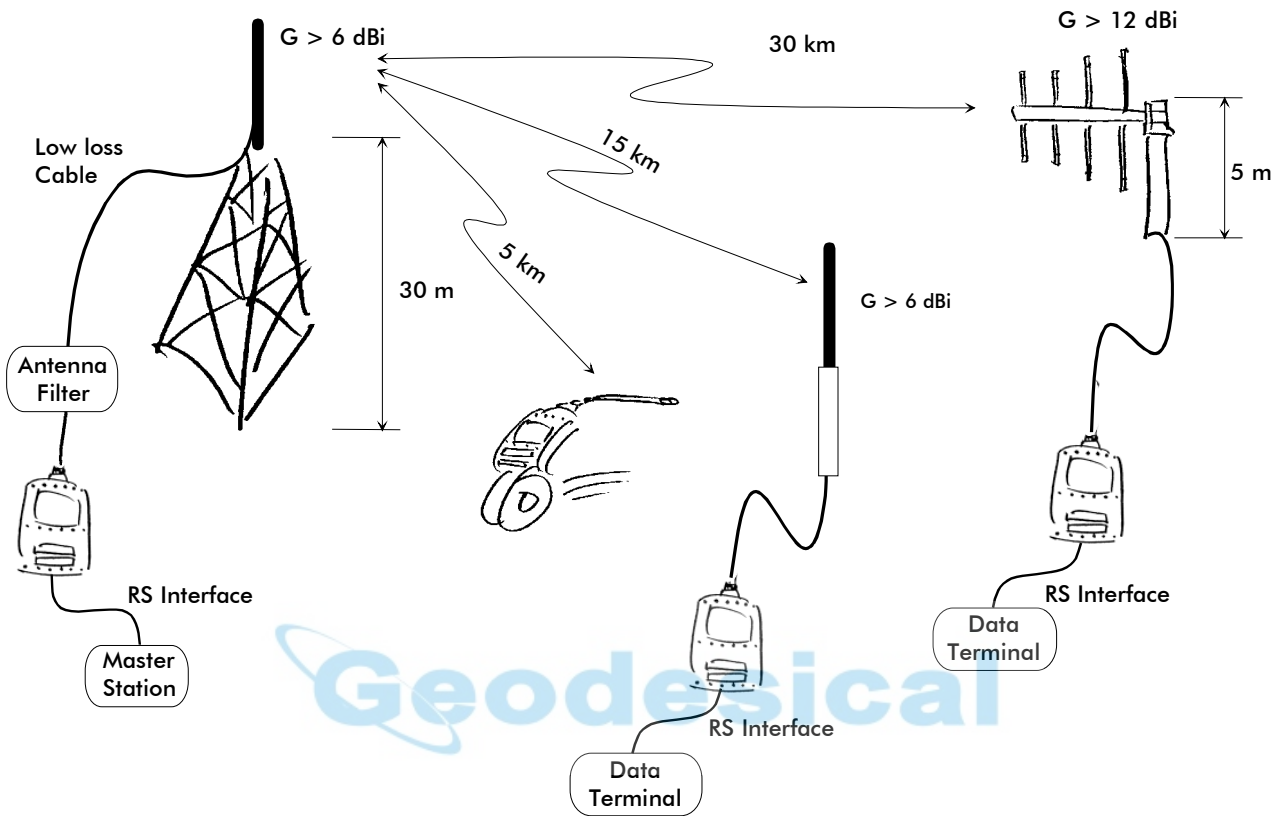

## 11 DESIGNING SYSTEMS

### 11.1 Factors affecting the quality and distance of the radio connection

- power of the radio transmitter
- sensitivity of the radio receiver
- tolerance of spurious radiation's of the radio modulating signal
- amplification of transmitting and receiving antennas
- antenna cable attenuation
- antenna height
- natural obstacles
- interference caused by other electrical equipment

The transmitter power of the base model of SATELLINE-3AS is 1 W (maximum) and the sensitivity of the receiver better than -115 dBm. Thus in a flat area and in free space with a 1/4 wave antenna (antenna amplification 1dBi) and antenna height of 1 m communication distances of 3 to 4 km can be achieved. Distances may be considerably shorter in situations where there are metallic walls or other material inhibiting the propagation of radio waves.

Over long distances, increasing the height of antennas can often solve problems caused by natural obstacles. A ten-fold increase in distance can be achieved with the use of amplifying antennas. Frequent topographical variations over long distances may require that at least one of the antennas be raised to a height of 10 to 20 m.

If the antenna cable is more than 10 meters long it is necessary to use a low loss cable (< 0.7 dB /10 m) in order not to waste the antenna amplification. Adding a repeater station can also solve problematical radio connections. In systems with many base stations the RSSI-signal can be used to assist in choosing the base station with the best signal. A communications network can also be built with a combination of cables and radio data modems.

The SATELLINE-3AS radio data modem operates in the 450 MHz band, where man made interference is insignificant. Long distance interference need not to be taken into account even in special weather conditions.

The SATELLINE-3AS tolerates normal levels of interference that occur. However, exceptionally high levels of interference can break through the safeguards and thus cause errors in data transfer. In mobile vehicle applications the range of operation can be increased by dividing the transmitted data into e.g. 50...500 byte long blocks and by re-transmitting the defected blocks.

A sufficient safety margin can be obtained by testing the communication path using extra 6 dB attenuation at the antenna connection and with slightly less effective antennas than those to be used in the final system.

## **11.2 Radio field strength**

Radio signal strength must be good enough for successful data transfer. Where field strength is above a certain level, the operational results are very good. Below this level, a few dB marginal areas occur in which errors begin to be generated by noise and interference that will eventually lead to loss of connection.

The field strength is at its optimum level in open space, although increasing distance will still reduce it. It must also be remembered that one open space has different environmental and external factors to another, and that the effects on transmission quality must be taken into account when planning the system.

Ground, ground contours and buildings cause attenuation (loss of energy through absorption) and reflection of radio waves. Buildings reflect radio waves and therefore the affects of attenuation are not as acute when transmission is over a short distance.

However, the reflected waves will often be a bit delayed, and when they combine with the direct radio waves they interact in either a weakening or a strengthening way. This causes the fading effect in mobile systems. In reality very sharp signal drops spaced about 35 cm apart may occur. The attenuation may even reach 40 dB, normally less.

## **11.3 Remarks concerning the 869 MHz frequency band**

According to a recommendation of ETSI, the frequencies range 869.4...869.65 MHz is reserved for use of license free radio appliances. The application of this recommendation varies in each country, and for this reason local regulations concerning this frequency range must always be checked.

In frequency range 869.4...869.65 MHz, the maximum allowed radiated power of an antenna is 500 mW erp (+27dBm). When calculating the power antenna cable attenuation and antenna gain must be taken into account. For example, if the gain of the antenna is 10 dBd and the attenuation of the antenna cable used is -3dB, the maximum allowed transmission power is 100 mW (+20 dBm). It should be noted that by increasing the gain of the antennas, connection distance could be increased. This is due to the fact that the output power of the transmission remains constant, but the added antenna gain of the receiving end will enable reception of weaker signals than otherwise possible.

System designers must also take into account that at the frequency range of 869.4...869.65 MHz the transmitter is allowed to be ON only 10% of the time. Whether this limit is exceeded or not, depends on the protocol used. At a frequency range of 869 MHz there are in addition to the frequency channel 869.4...869.65 MHz also other ranges, but at these ranges the maximum allowed radiated power is 25 mW and the transmitter is allowed to be ON only 1 % or 0.1 % of the time.



## 12 CHECK LIST

The following points must be taken into account when installing and configuring a radio modem:

1. All operating voltages of all the equipment concerned must always be switched OFF before connecting the serial interface cable.
2. When considering the exact placement of a radio modem and/or its antenna, the following points must be taken into account to guarantee optimal results:
  - The antenna should be installed in open space as far as possible from any possible sources of interference
  - The radio modem should not be installed onto a strongly vibrating surface
  - The radio modem should be installed in such a way as to minimise exposure to direct sunlight or excessive humidity.
3. To ensure reliable operation the voltage output of the power supply used must be stable enough and the current capability of the power supply must be sufficient.
4. The antenna must be installed according to instructions.
5. Settings of the radio modem must correspond to settings of the terminal.
6. All radio modems in the same system must be configured using same settings (radio frequency, channel spacing and data field length). See Chapter 5.1.

## 13 ACCESSORIES

### 13.1 RS-232 cables and adapters

Type	Description	Length	Note
NARS-1F	Interface adapter D15 m / D9 f, 650 mA fuse	-	including 2 m power supply cables a and programming switch
NARS-1F-4A	As NARS-1F with 4A fuse for Epic only		
CRS-9	Interface cable D9 m / D9 f	2 m	-
CRS-1M	Interface cable D15 m / D25 m	2 m	including power supply cables
CRS-1F	Interface cable D15 m / D25 f	2 m	including power supply cables
CRS-2M	Interface cable D15 m / D9 m	2 m	including power supply cables
CRS-2F	Interface cable D15 m / D9 f	2 m	including power supply cables

Note! In the description, m=male, f=female connector type.

### 13.2 RS-485/422 cables and adapters

Type	Description	Length	Note
NARS-2	Interface adapter D15 m / screw terminals, 650 mA fuse	-	Screw terminals for RS-485/422 and power supply
NARS-2-4A	As NARS-2 with 4A fuse for Epic only	-	
CRS-PB	Interface cable D15 m / D9 m	2 m	including power supply cables

### 13.3 RF-cables

Type	Description	Length	Note
CRF-1	Cable with TNC m/TNC f-connectors	1 m	RG58 (3 dB/10 m)
CRF-5F	Cable with TNC m/TNC f-connectors	5 m	RG58 (3 dB/10 m)
CRF-5M	Cable with TNC m/TNC m-connectors	5 m	RG58 (3 dB/10 m)
CRF-15	Cable with TNC f/TNC f 90-degree connector	15 cm	RG58 (3 dB/10 m)
RG213	Low loss cable	X	1,5 dB/10 m
AIRCOM+	Low loss cable	X	0,7 dB/10 m

Note! In the description, m=male, f=female connector type.

### 13.4 Antennas

Type	Description
GAINFLEX 400-430	Half-wave antenna
GAINFLEX 430-470	Half-wave antenna
CA420Q	Sleeve fed quarter wave whip, 2dBi, 405–440 MHz
CA450Q	Sleeve fed quarter wave whip, 2dBi, 440-475 MHz
MINIFLEX 400-430	Helix antenna
MINIFLEX 430-470	Helix antenna
ANTENNA 869	Quarter wave antenna for 869 MHz modems

SATEL antenna selection includes also directional and/or omni-directional antenna. These can be supplied separately on request. Antennas are also available for the 869 MHz frequency range.

### **13.5 Filters and lightning protectors**

If a radio modem system is installed in an environment that contains high-power transmitters or sources of radio frequency interference, it is highly recommendable to insert suitable filters between each radio modem and its antenna. If a station is installed to a location exposed to lightning, it is recommended to insert a lightning protector to the feed-line outside the protected zone. SATEL Customer Support can give guidance in the selection of suitable filters or protectors.

### **13.6 Power supplies**

Type	Description
MAS-2	230 Vac/12 Vdc/1A
MAS-4	230 Vac/12 Vdc/5A

### **13.7 Batteries**

Type	Description
SATEL-321	Weather proof battery pack with extended life time
SATELSET-60	Battery Pack with a 60 mm Belt Clip
SATELSET-90	Battery Pack with a 90 mm Belt Clip
SET-BC	Battery Cassette, 1800 mAh capacity
SET-C	Charger
SET-IC	Installation Cradle

### **13.8 Installation and enclosures**

Type	Description
I-DIN	Installation plate for DIN rail mounting for 3AS(d) modems
I-DIN Epic	Installation plate for DIN rail mounting for Epic
H-WP	Weather proof housing (IP54) for 3AS(d) modems
H-WP-X2	Weather proof housing (IP54) for Epic modems
H-EX	Housing for potentially explosive environment, EEx d IIC T6 (also IP67)

## 14 APPENDIX A

ASCII CHARACTER TABLE																	
D	H	A	D	H	A	D	H	A	D	H	A	D	H	A	D	H	A
0	0	NUL	43	2B	+	86	56	V	129	81		172	AC		215	D7	
1	1	SOH	44	2C	,	87	57	W	130	82		173	AD		216	D8	
2	2	STX	45	2D	-	88	58	X	131	83		174	AE		217	D9	
3	3	ETX	46	2E	.	89	59	Y	132	84		175	AF		218	DA	
4	4	EOT	47	2F	/	90	5A	Z	133	85		176	B0		219	DB	
5	5	ENQ	48	30	0	91	5B	[	134	86		177	B1		220	DC	
6	6	ACK	49	31	1	92	5C	\	135	87		178	B2		221	DD	
7	7	BEL	50	32	2	93	5D	]	136	88		179	B3		222	DE	
8	8	BS	51	33	3	94	5E	^	137	89		180	B4		223	DF	
9	9	HT	52	34	4	95	5F	_	138	8A		181	B5		224	E0	
10	A	LF	53	35	5	96	60	`	139	8B		182	B6		225	E1	
11	B	VT	54	36	6	97	61	a	140	8C		183	B7		226	E2	
12	C	FF	55	37	7	98	62	b	141	8D		184	B8		227	E3	
13	D	CR	56	38	8	99	63	c	142	8E		185	B9		228	E4	
14	E	SO	57	39	9	100	64	d	143	8F		186	BA		229	E5	
15	F	SI	58	3A	:	101	65	e	144	90		187	BB		230	E6	
16	10	DLE	59	3B	;	102	66	f	145	91		188	BC		231	E7	
17	11	DC1	60	3C	<	103	67	g	146	92		189	BD		232	E8	
18	12	DC2	61	3D	=	104	68	h	147	93		190	BE		233	E9	
19	13	DC3	62	3E	>	105	69	i	148	94		191	BF		234	EA	
20	14	DC4	63	3F	?	106	6A	j	149	95		192	C0		235	EB	
21	15	NAK	64	40	@	107	6B	k	150	96		193	C1		236	EC	
22	16	SYN	65	41	A	108	6C	l	151	97		194	C2		237	ED	
23	17	ETB	66	42	B	109	6D	m	152	98		195	C3		238	EE	
24	18	CAN	67	43	C	110	6E	n	153	99		196	C4		239	EF	
25	19	EM	68	44	D	111	6F	o	154	9A		197	C5		240	F0	
26	1A	SUB	69	45	E	112	70	p	155	9B		198	C6		241	F1	
27	1B	ESC	70	46	F	113	71	q	156	9C		199	C7		242	F2	
28	1C	FS	71	47	G	114	72	r	157	9D		200	C8		243	F3	
29	1D	GS	72	48	H	115	73	s	158	9E		201	C9		244	F4	
30	1E	RS	73	49	I	116	74	t	159	9F		202	CA		245	F5	
31	1F	US	74	4A	J	117	75	u	160	A0		203	CB		246	F6	
32	20	SP	75	4B	K	118	76	v	161	A1		204	CC		247	F7	
33	21	!	76	4C	L	119	77	w	162	A2		205	CD		248	F8	
34	22	"	77	4D	M	120	78	x	163	A3		206	CE		249	F9	
35	23	#	78	4E	N	121	79	y	164	A4		207	CF		250	FA	
36	24	\$	79	4F	O	122	7A	z	165	A5		208	D0		251	FB	
37	25	%	80	50	P	123	7B	{	166	A6		209	D1		252	FC	
38	26	&	81	51	Q	124	7C		167	A7		210	D2		253	FD	
39	27	'	82	52	R	125	7D	}	168	A8		211	D3		254	FE	
40	28	(	83	53	S	126	7E	~	169	A9		212	D4		255	FF	
41	29	)	84	54	T	127	7F		170	AA		213	D5				
42	2A	*	85	55	U	128	80		171	AB		214	D6				

## 15 APPENDIX B

### 15.1 Functional delays

Function	Delay (ms)
Wakeup time from STAND-BY to ON (controlled by DTR line)	200
Serial interface, turnaround time of RS-232	0
Serial interface, turnaround time of RS-485	< 1
Intercharacter delay	max. 2-3 characters
SL-Ping response time from remote modem	129

#### SL-Ping response time (typical) in Source Routing network:

$t$  = SL-Ping response time from router

router.count = Count routers from master to router/slave to ping

Response time from router/slave =  $(t * (\text{router.count} + 1)) + 1 \text{ ms}$

Example Response time from slave behind two routers

$(129 \text{ ms} * (2 + 1)) + 1 \text{ ms} = 388 \text{ ms}$

### 15.2 Transmission related delays

Delay from the end of transmission to the end of reception on the serial interface:

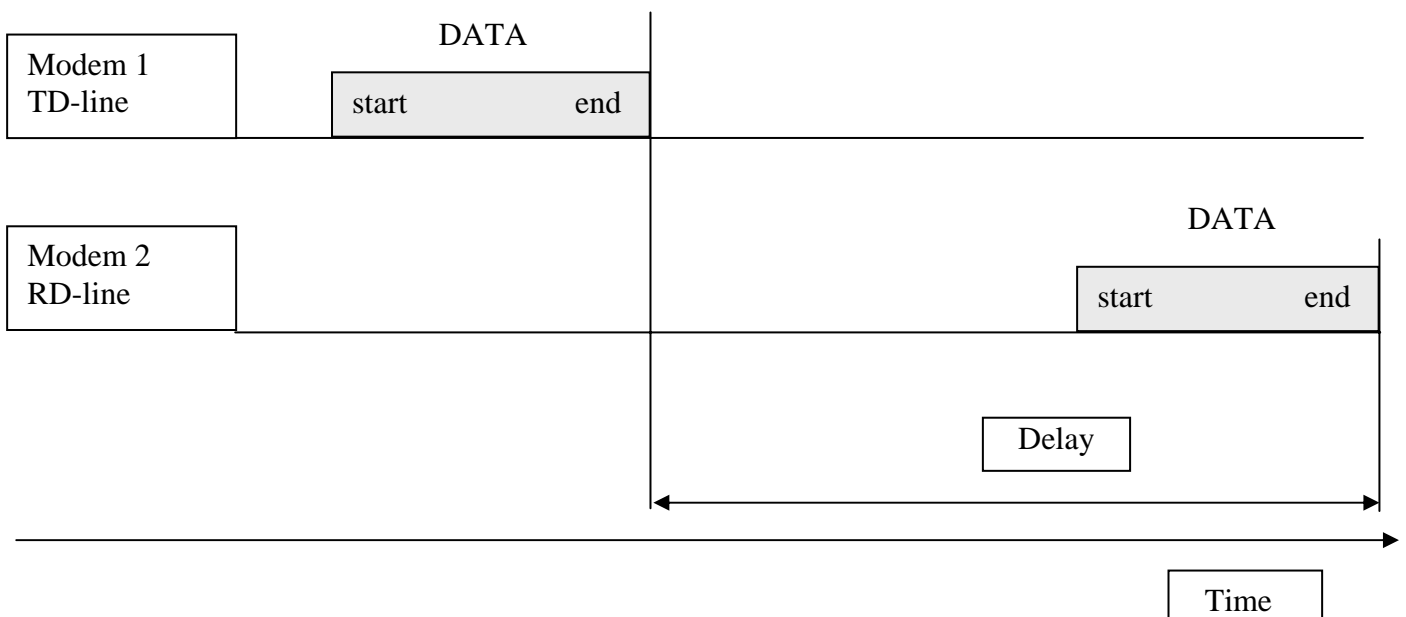

### 15.2.1 Transmission delays when using a 12.5 kHz radio channel

Transmission delays (ms) without FEC-function (Forward Error Correction).

Number of bytes sent

Bps	1	10	100	500
1200	38	38	38	38
4800	33	32	32	32
9600	31	31	31	31
19200	31	33	65	195
38400	31	36	88	322

Delays are in milliseconds and with a 10% margin.

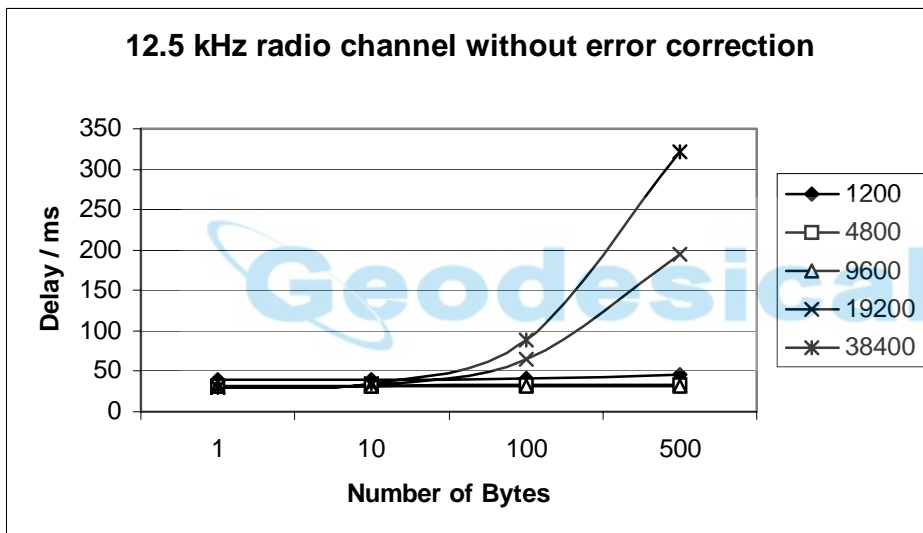

Transmission delays with FEC-function (Forward Error Correction).

Number of bytes sent

Bps	1	10	100	500
1200	50	50	51	50
4800	44	44	44	44
9600	43	43	66	126
19200	43	42	104	364
38400	47	46	132	496

Delays are in milliseconds and with a 10% margin.

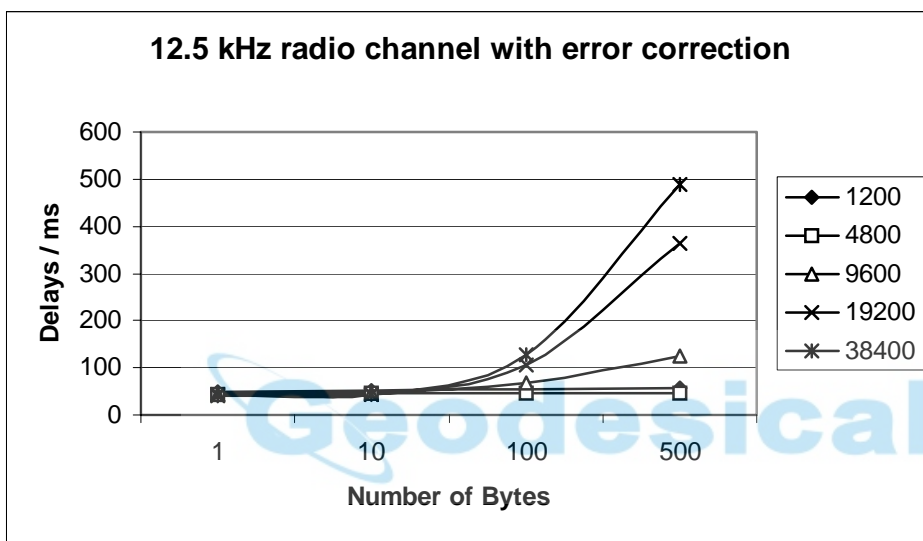

### 15.2.2 Transmission delays using a 25 kHz radio channel

Transmission delays without FEC-function (Forward Error Correction).

Number of bytes sent

Bps	1	10	100	500
1200	28	28	28	28
4800	22	22	22	22
9600	21	21	21	21
19200	23	23	22	23
38400	25	23	36	101

Delays are in milliseconds and with a 10% marginal.

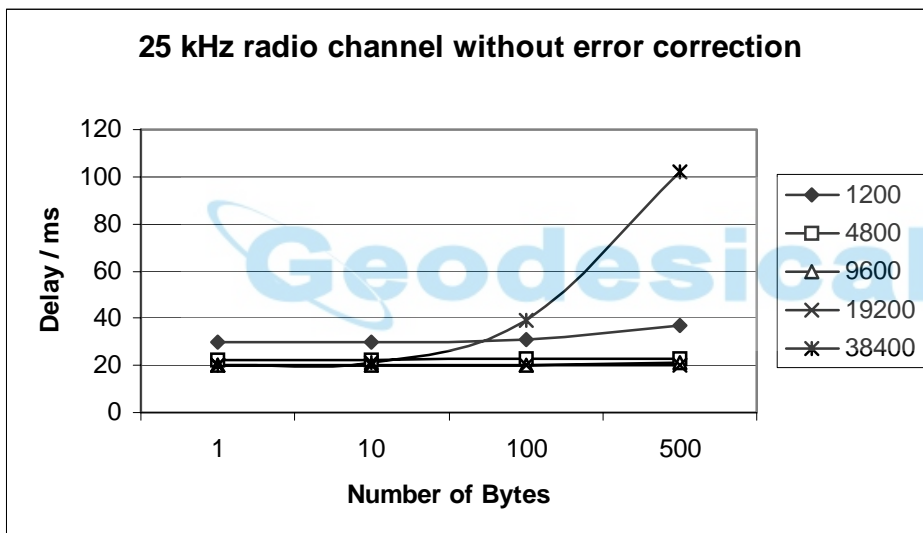



Transmission delays with FEC-function (Forward Error Correction).

Number of bytes sent

Bps	1	10	100	500
1200	34	34	34	34
4800	28	28	28	28
9600	27	32	28	31
19200	35	31	35	64
38400	33	33	57	185

Delays are in milliseconds and with a 10% margin.

