

# PENTAX

---

INSTRUCTION MANUAL

ELECTRONIC TOTAL STATION

**PTS-V SERIES**

The logo for Geodesical, featuring the word "Geodesical" in a light blue, sans-serif font. A light blue ring or orbit surrounds the letter "G".

PTS-V2/PTS-V2c/PTS-V3/PTS-V3c/PTS-V5

ASAHI PRECISION CO., LTD.

Thank you for purchasing the pentax Electronic Total Station PTS-V Series. This PTS-V Series was developed based on the concept that operation should be simple enough for mastery without extensive training, but at the same time the user should have access to high-level and sophisticated functions. We are confident that, by following the instructions in this manual, you will be completely satisfied with the operation and performance of your instrument. We hope that you will continue to enjoy and rely on Pentax products in the future as well.

The logo for Geodesical, featuring the word "Geodesical" in a light blue, sans-serif font. A light blue, three-dimensional ring or sphere is positioned behind the letter "G", partially overlapping it.

Please keep this instruction manual in a safe place.  
In the event that the manual is lost, a replacement can be ordered, but the user will be charged a fee for replacement

## **Simplified key operation**

The functions of the five operation keys are displayed on the display panel using segment characters, and the number keypad can be used to input numeric settings and numbers. Thus, key operation has been kept simple and minimal.

## **A large selection of application software**

The equipment comes with 18 different application programs to handle operations such as traverse, resection, coordinate stake-out, and coordinates, allowing various types of surveying operations to be carried out efficiently.

## **Simple function access**

All functions, including special functions such as changes in prism constants, changes in the minimum display angle, and traverse measurements, can be accessed simply by using a three digit code, preceded by "007". This eliminates the need for complicated key operations.

## **Long-life battery**

Two battery packs are provided as standard equipment, so that the instrument can be operated for approximately 5.0 hours before running out of battery power. The battery charger also has a discharging function, so that the user no longer needs to worry about problems such as the "memory effect" phenomenon which sometimes accompany battery operation.

Please keep this instruction manual in a safe place. In the event that the manual is lost, a replacement can be ordered, but the user will be charged a fee for replacement manuals.

## General

Features .....	1
----------------	---

## Before Using Instrument

Usage precautions .....	5
Unpacking and storing .....	7
Names and functions of parts .....	8
Features of this manual .....	10
Segment characters .....	11
Key functions .....	12

## Battery

Removing the battery .....	15
Attaching the battery .....	15
Charging the battery .....	16
Removing the battery pack from the battery charger .....	16
Refreshing the battery .....	17

## Turning the power on

Turning the power on and off .....	18
Indexing the vertical 0 point .....	18
Adjusting the contrast of the LCD .....	19
Adjusting the brightness of the illumination .....	19

## Measuring an angle

Measuring a horizontal angle .....	20
Resetting the 0 point for the horizontal angle .....	20
Horizontal angle hold .....	21
Changing to a counterclockwise horizontal angle .....	22
Displaying the % slope of the vertical angle .....	23

## Measuring a distance

Normal distance measuring .....	24
Fast distance measuring .....	25

**Function operations**

Selecting the mode .....26  
 Selecting the menu .....27  
 Correction functions (inputting prism constant, temperature, and air pressure settings) .....28  
 Inputting data .....30  
 Direct access to functions .....32  
 Command No. Table .....33  
 Help function .....34

**Registering programs**

Group selection .....36  
 Registering groups in the tool kit .....38

**Special functions**

Special functions .....40  
 Accessing the special functions .....40  
 Measurement with the coordinate stake-out function .....42  
 The order of steps and operative illustrations .....43  
     Step 1 .....44  
     Step 2 .....45  
     Step 3 .....46  
     Step 4 .....46  
     Step 5 .....47  
 Contents of application programs .....49  
 Equation of scaling .....51

**Initial settings**

Initial settings .....52  
 Accessing the initial settings .....52  
 Entering values for the initial settings .....52  
 Contents of initial settings .....54  
     "Initial settings A" .....54  
     "Initial settings B" .....55  
     "Initial settings C" .....58  
     "Initial settings D" .....59  
     "Initial settings E" .....59  
 Using the Quick set function for setting values .....60  
 Table of items applicable to the quick set function .....62

**Preparation for surveying**

Centering and leveling of the instrument .....	64
Setting up the instrument and the tripod .....	64
Centering and leveling with the optical plummet .....	64
Leveling with the plate vial .....	65
Eyepiece adjustment and sighting .....	66
Eyepiece adjustment .....	66
Object sighting .....	66
Attach and detachment of tribrach .....	67

**Inspection and adjustment**

Plate vial .....	68
Circular vial .....	69
Optical plummet .....	70
Reticle .....	71
Perpendicularity of line of sight to horizontal axis .....	72
Vertical 0 point error .....	73
Offset constant .....	74
Beam axis and line of sight .....	75

**Specifications** .....76**External power source**

External battery (MB22) specifications .....	78
External battery charger (MC22) specifications .....	78
Usage .....	78
Charging .....	79

**APPENDIX**

Tri Axis Compensation(Inclination compensation) .....	80
Atmospheric refraction and earth curvature .....	81
Atmospheric correction .....	82
Deviation of distance when no atmospheric correction is made .....	83
Error messages .....	84

## Usage Precautions

Surveying instruments are high-precision devices. In order to assure that the surveying instrument you have purchased will provide long lasting maximum performance, it must be used according to this manual's instructions.

### Solar Observation

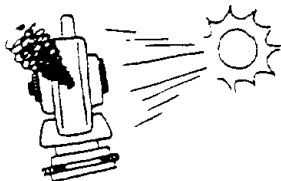

Never point the telescope directly at the sun, as this will damage internal components.

When using the instrument for solar observation, attach the objective lens solar filter designed to protect the internal components.

### Storage and Environmental Conditions

- a. Avoid storing instrument in places exposed to extremely high, low, or radically fluctuating temperatures. (Ambient temperature range during use:  $-20^{\circ}\text{C}$  to  $+50^{\circ}\text{C}$  /  $-4^{\circ}\text{F}$  to  $+122^{\circ}\text{F}$ )

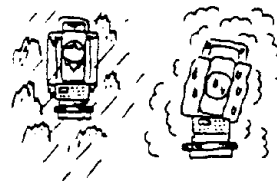

- b. Distance measurement may take longer under adverse climatic conditions, such as a heat waves. We recommend increasing the number of prisms when surveying under difficult weather conditions.

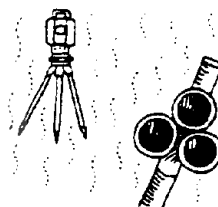

- c. When storing the instrument, always put it in its case and store it in a location protected from vibration. Also avoid locations that are dusty and subject to extreme humidity.



- d. If there is a sharp temperature difference between the instrument's storage and usage locations, let the instrument adjust to the ambient conditions before using.

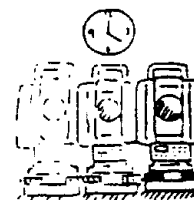

- e. If the instrument is to be stored for a long period of time, the battery should be charged approximately once a month. Also, occasionally, the instrument should be taken out of its case and aired out.

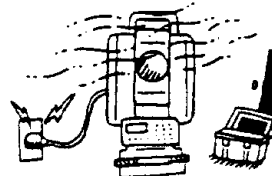

### Transporting and Carrying Instrument



a. When transporting and shipping this instrument, be careful to protect it from impact and vibration.

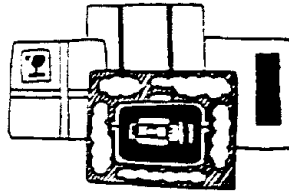

b. When transporting the instrument, always put it in the case and wrap shock-absorbing material around it. Mark the package "FRAGILE" to ensure gentle handling.

### Other Precautions

a. While attaching the instrument to a tripod, or removing it from a tripod, always steady it with one hand.



b. Before beginning work, always inspect the instrument to make sure there are no problems. If any problems are discovered, adjust or repair the instrument before use.

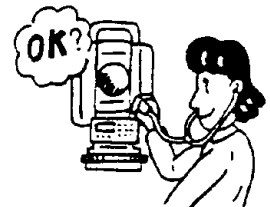

c. Never disassemble the instrument yourself, even if you have found a problem. If you believe repair is needed, please contact your Authorised Pentax Dealer or Pentax Factory to have the repairs done.

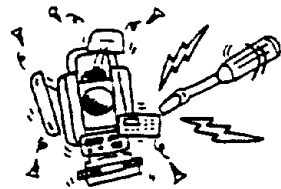

d. In addition to the above precautions, be sure to follow the items and instructions noted in the manual, and make sure that the instrument is used properly.





## Unpacking and storing

### Taking the Instrument Out of the Case

1. Set the case down gently, with the lid facing upwards.
2. Open the latches while pressing down on the lock (this is a safety feature), and open the lid of the case.
3. Take the instrument out of the case.

### Storing the Instrument in the Case

1. Make sure the telescope is fairly level, and lightly tighten the vertical tangent lock screw.
2. Line up the housing marks (round yellow marks on the instrument), and tighten the upper and lower tangent lock screws.
3. With the housing marks facing upward, set the instrument gently in the case, not applying excessive force.
4. Close the lid of the case and secure the latches.

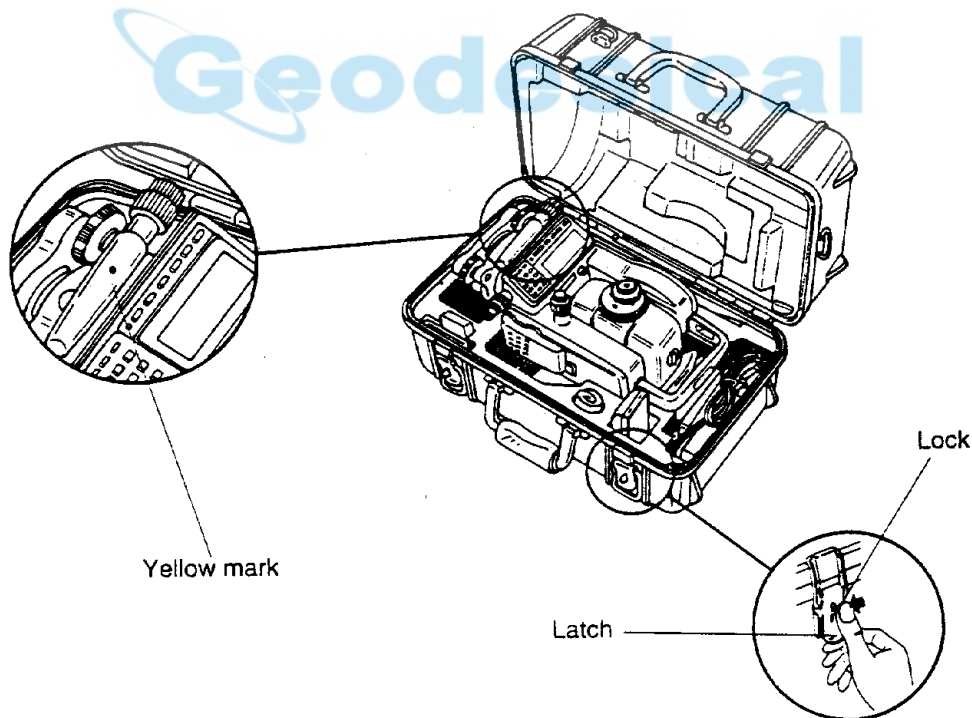

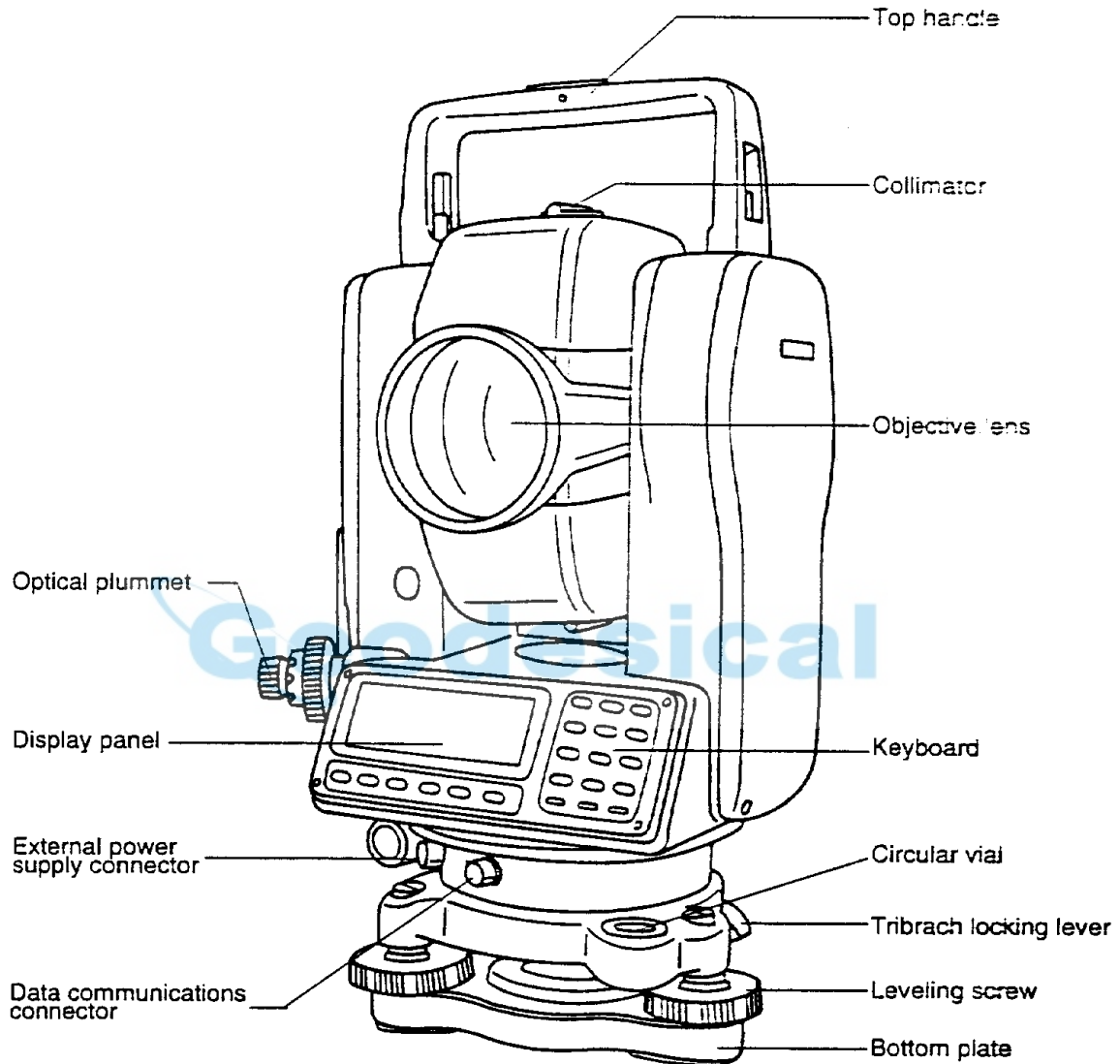
**Names and Functions of Parts**

The illustration shows the PTS-V2/V3/V5 model.

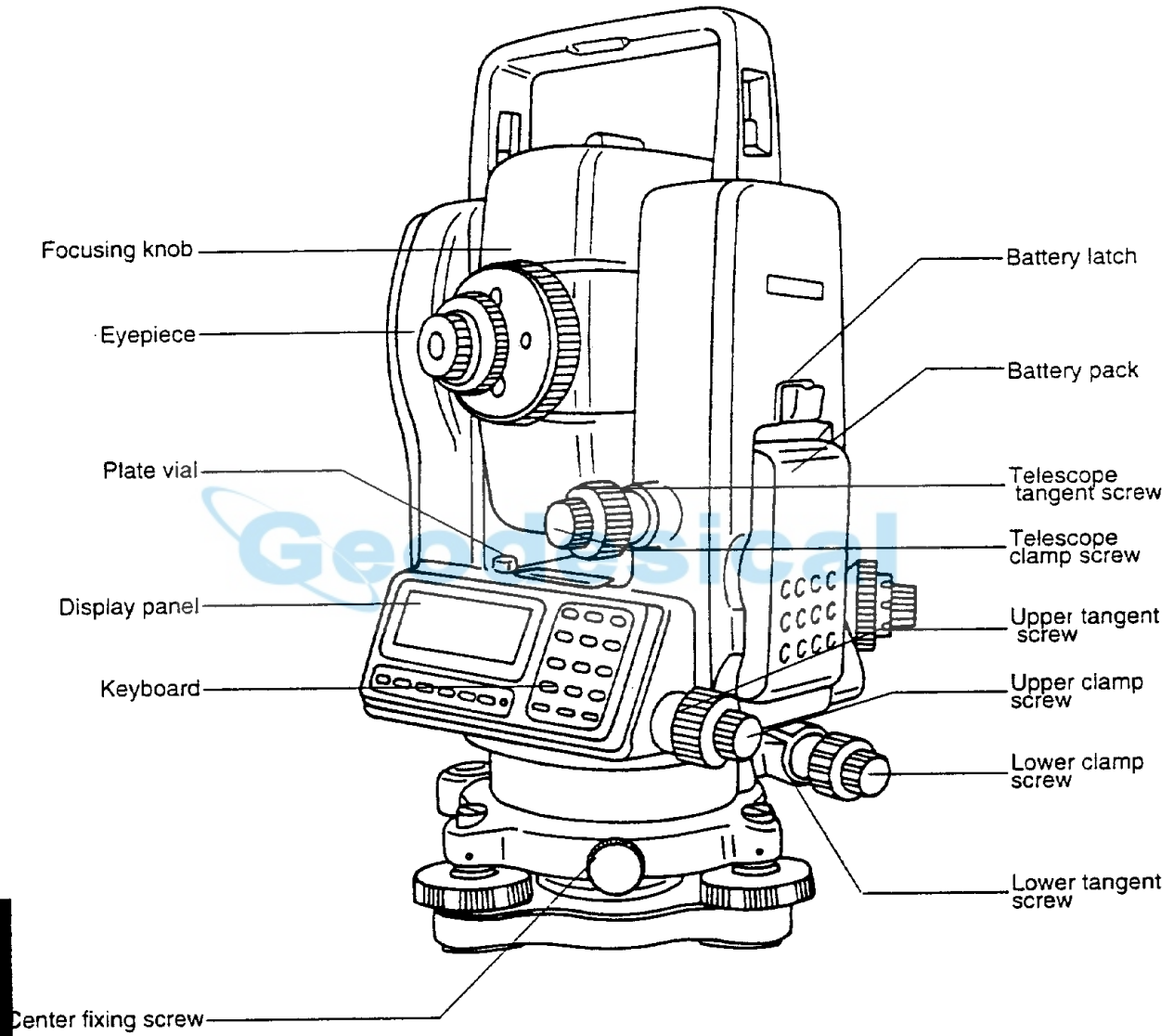

The illustration shows the PTS-V2c/V3c model.

## Features of This Manual

Diagrams are excerpts from actual illustrations. In this manual, descriptions of keyboard operations use diagrams taken from the actual keyboard illustrations.

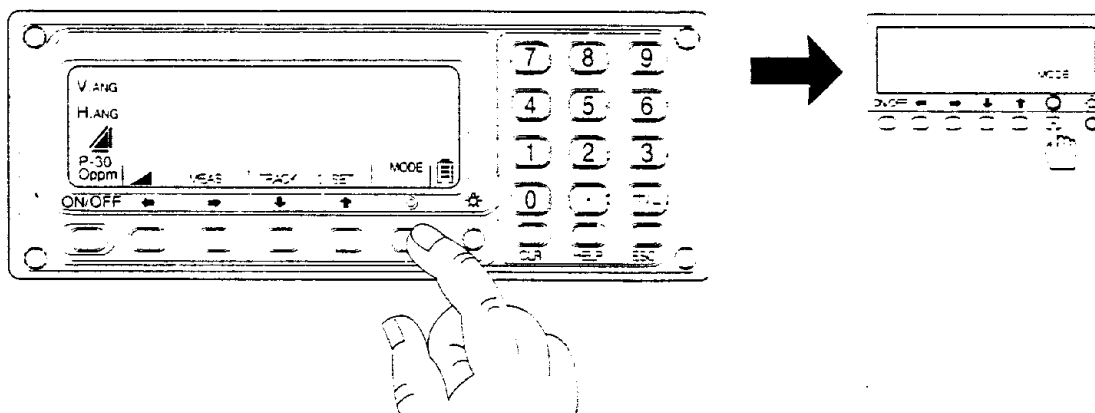

### Names of keys

When segment characters (or ▲ marks) are displayed on the screen, the names of the keys are indicated on the screen. When nothing is displayed on the screen, an arrow mark placed between the screen and key indicates the name of key right below the mark.

### Pressing keys twice

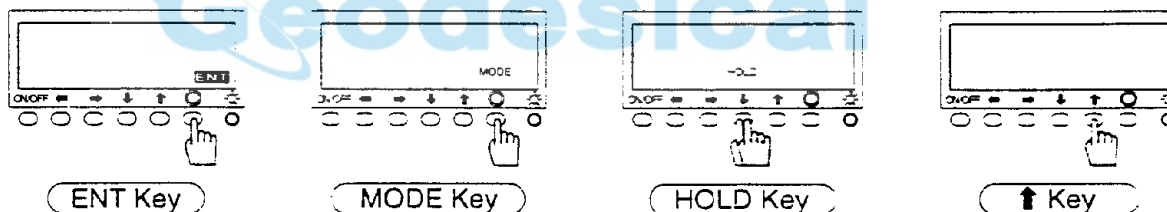

When the [H ANG 0 RESET] and [HOLD] keys are pressed, a high-pitched electronic beep is produced. This warns the user to confirm the operation in order to avoid errors. Pressing the key directly under the flashing screen characters, while the beep is still sounding, activates the function being accessed. If the key is not pressed a second time, the beeping sound stops, and the screen returns to the original status.

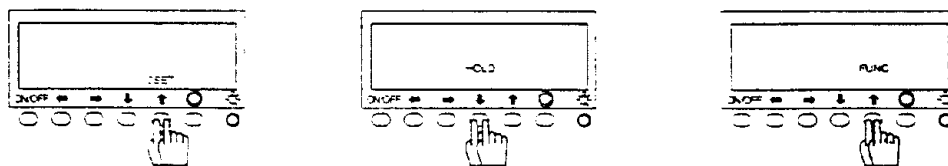

## Segment Characters

The section below explains the meanings of segment letters and characters which appear on the screen.

● SEND mark: This is displayed during communications with an external unit such as a data recorder.

⊛ RECEIVE mark: This is displayed when the [MEAS] key is pressed and the instrument receives returning light from a prism.

H ANG: This indicates that the displayed data shows the horizontal angle.

V ANG: This indicates that the displayed data is a vertical angle. In case of a compass reading, it indicates the vertical angle.

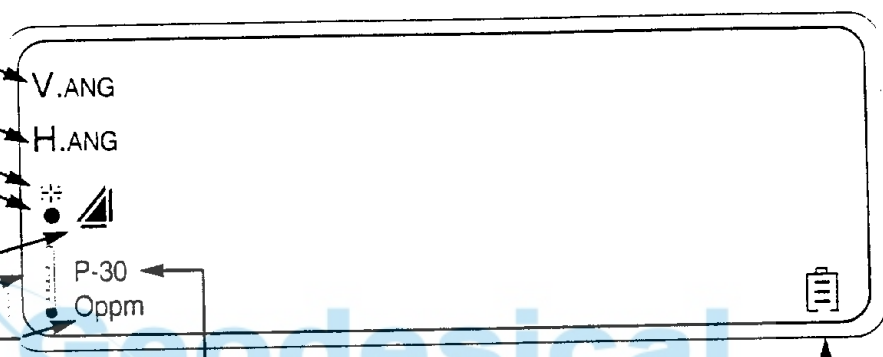

⊞ Battery mark: This is displayed in three stages which indicate the amount of battery power left.

P-30: This is displayed when the prism constant is -30 mm.

P-0: This is displayed when the prism constant is 0 mm.

ppm: This is displayed when the atmospheric compensation function is being used.

0ppm: This is displayed when the atmospheric compensation value is 0 ppm.

🌡 Thermometer mark: This is displayed when the automatic atmospheric compensation function is set to "ON."

▲ Triangle mark and slope line: This indicates that the displayed distance is an slope distance.

▲ Triangle mark and horizontal line: This indicates that the displayed distance is a horizontal distance.

▲ Triangle mark and vertical line: This indicates that the displayed distance is a vertical distance.

## Key Functions

The following descriptions indicate what happens when the various keys are pressed.

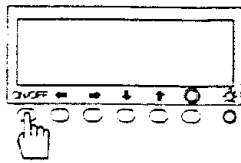

[ON/OFF] key: This turns the power on and off.

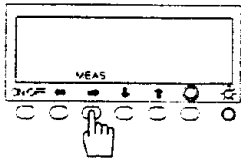

[MEAS] key: This changes the measurement in mm (.005ft.) units from "Shots (specified number of times) Measurement" to "Continuous Measurement" to "Measurement Stop".

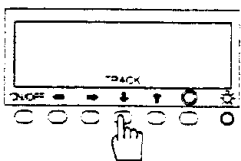

[TRACK] key: This changes the measurement in cm (.05ft.) units from "Continuous Measurement" to "Shots (specified number of times) Measurement" to "Measurement Stop".

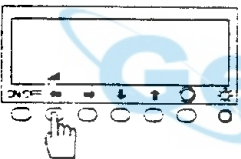

[  ] key : This changes the display in sequential order from horizontal distance to vertical distance to slope distance.

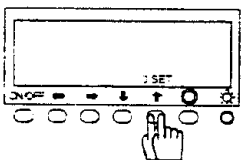

[0 SET] key : Pressing this key twice in succession resets the horizontal angle to 0.

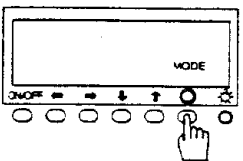

[MODE] key : This switches the screen alternately between A MODE and B MODE.

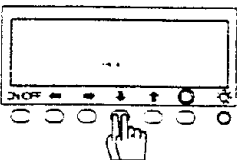

[HOLD] key : Pressing this key twice in succession retains the horizontal angle shown on the display.

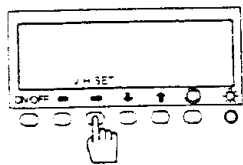

[V/H SET] key: This changes the screen from "Vertical Angle)" to "Input Horizontal Angle" to "Select Horizontal Angle Left / Right".

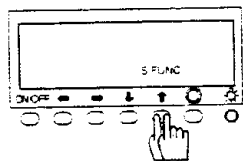

[S. FUNC] key: Pressing this key twice in succession accesses special functions such as application.

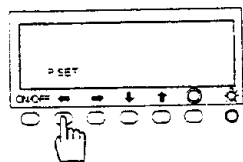

[P.SET] key: The prism constant, air pressure, and temperature are displayed.

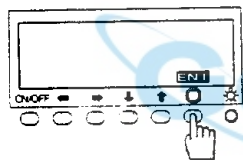

[ENT] key : This stores data which has been input, enters an item which has been selected, advances to the next operation, and performs similar functions.

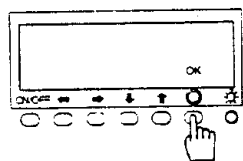

[OK] key : This enters a "Yes" response to a confirmation message.

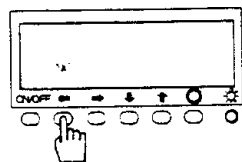

[NO] key : This enters a "No" response to a confirmation message.

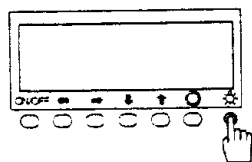

[ILLUMINATION] key: This turns the lighting on and off for the LCD panel and the telescope reticle.

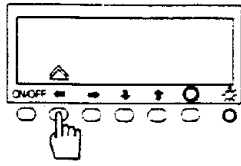

[ ← ] key : This returns to the previous screen.

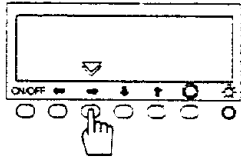

[ → ] key : This advances to the next screen.

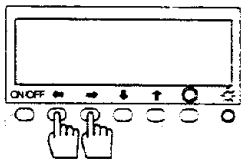

[ ← ] key : This moves the cursor to the left.

[ → ] key : This moves the cursor to the right.

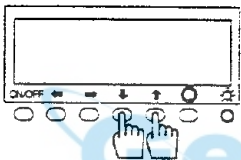

[ ↓ ] key : This moves the cursor downwards.

[ ↑ ] key : This moves the cursor upwards.



[CLR] key : This deletes one line of number data from the cursor is positioned.

[HELP] key : This displays the operation procedure and provides assistance.

[ESC] key : This interrupts whatever function is currently in process, and returns to the initial execution screen.

#### Number keypad

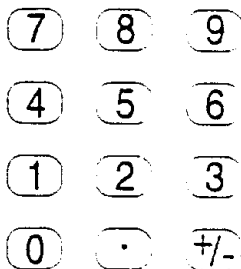

[0] to [9] keys: These are used for number input.

[ . ] key: This is used to input a decimal point.

[ +/- ] key: This displays the + (plus) and - (minus) marks alternately.



The battery pack (MB02) is not charged when it is shipped from the factory. It must be charged before use.

## Removing the battery

- 1 Press the latch above the battery pack, downwards, allowing the top of the battery pack to pop out slightly.
- 2 Lift the battery pack upwards at a slight angle to remove it from the main unit.

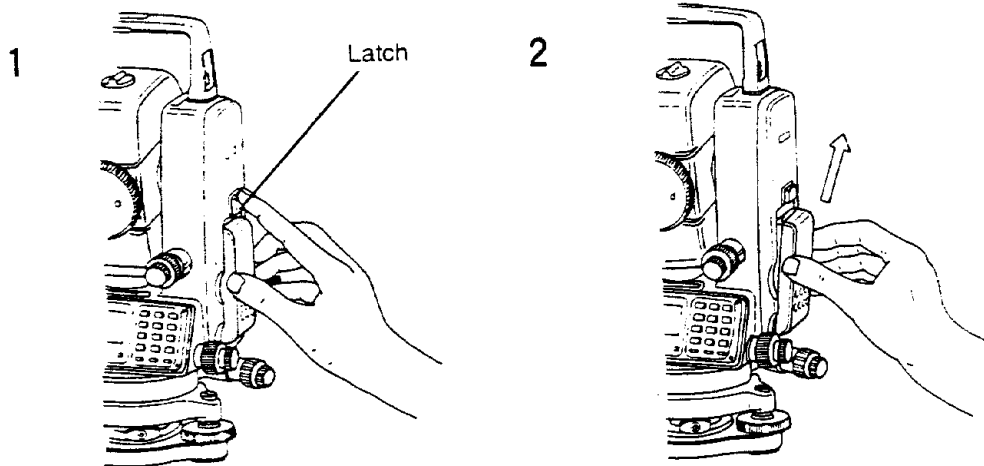

## Attaching the battery

- 1 Line up the guide pin on the battery pack with the guide grooves in the side cover, and insert the battery pack downwards into position.
- 2 Press the top of the battery pack in (towards the side cover) until you hear it click into place in the side cover.

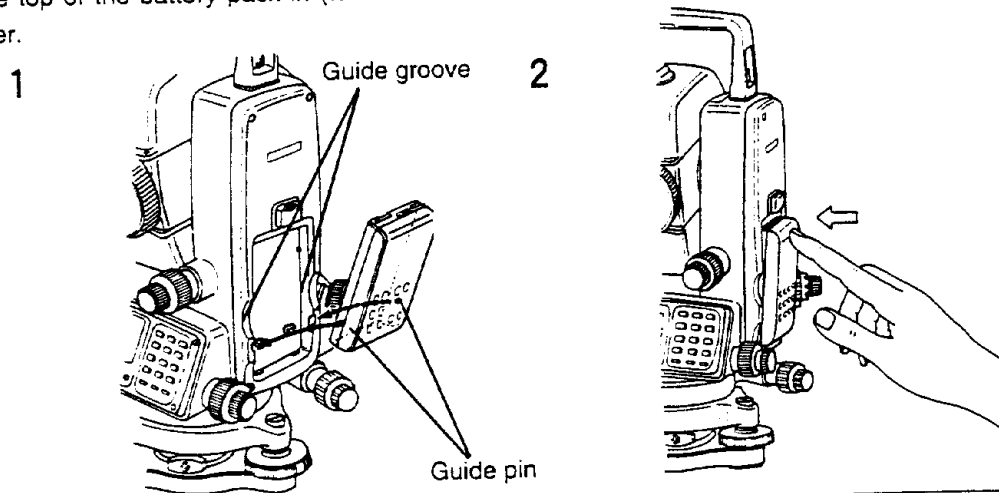

\* If the battery pack is pulled sideways, with excessive force when removing it, the grooves may be damaged. Remove the battery pack carefully, pulling gently away from the main unit.

# 16 BATTERY

## Charging the battery

The battery charger (MC02), only, should be used to charge the battery.

- 1 Insert the side of the battery pack with the identifying mark on it into the guide on the pilot lamp side of the battery charger.
- 2 Press on the battery pack until it fits tightly together with the battery charger. When the two are properly aligned, the sliding latch will retract and lock the battery pack into the charger.
- 3 Plug the socket into an AC power supply outlet. The power supply indicator (red) and charging indicator (green) light up and charging begins. When the charging indicator (green) goes out, the battery is completely charged.

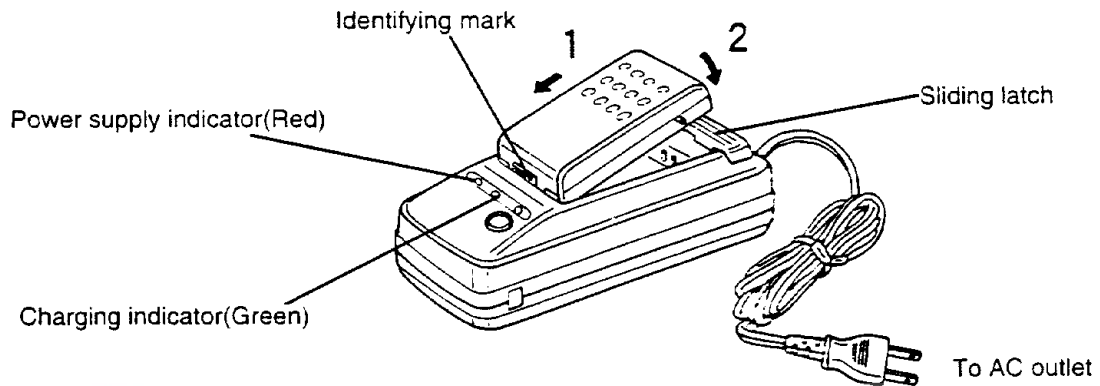

\* If the optional DC cord designed for automotive use is used, the cigarette lighter in a car can be used as a power supply.

## Removing the battery pack from the battery charger

Slide the sliding latch towards the power supply cord side, and lift the battery pack out of the charger.

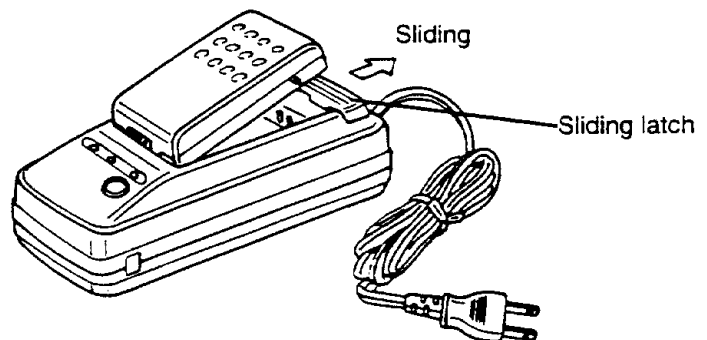

## Refreshing the battery

Ni-Cd batteries can be used repeatedly by charging them, but if they are repeatedly charged while there is still some capacity left, the amount of time that they can be used is gradually shortened because of a phenomenon known as the "memory effect." The battery voltage can be restored by a process known as "refreshing the battery," so that the full usage time is restored. The battery should be refreshed approximately once every five times charged.

### The refreshing process

- 1 Connect the power supply cord of the battery charger in which the battery pack has been placed to an AC power supply.
- 2 Press the "Refresh" button. The refresh Guide groove (yellow) lights and the discharging process begins. When all of the remaining battery power has been discharged, the charging process begins automatically.

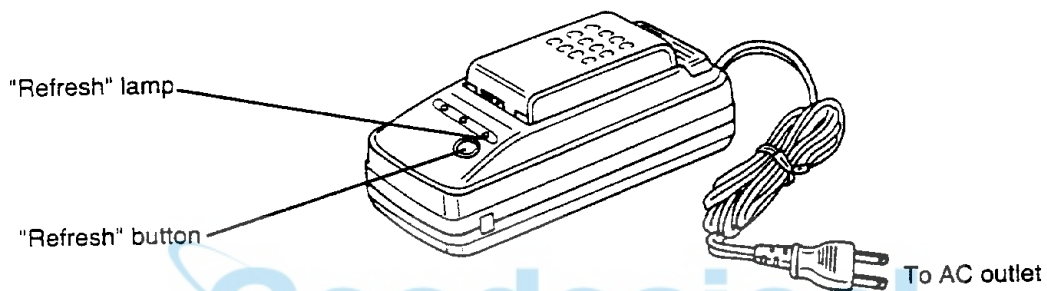

\* If the refreshing process has to be interrupted for some reason, take the battery pack out of the charger.

### Refreshing and charging time

Refreshing time and charging time:

Refreshing Time  
Approx. 200 min.

Charging Time  
Approx. 60 min.

\* The time required for refreshing indicated in the table is the time required when the battery is at full capacity. If the battery capacity is low, the refreshing process takes less time.

## Turning the power on and off

Pressing the [ON/OFF] key turns the power on, and pressing it again turns the power off.

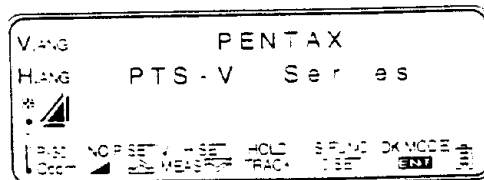
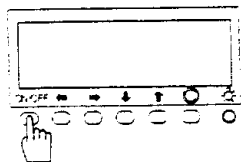

- 1 When the power supply is turned on, the horizontal angle (clockwise reading) and a guide message reading "TURN TELESCOPE \* \* \*" are displayed on the screen.
- 2 Turning the telescope up and down as instructed by the guide message, which set the 0 point for the vertical circle, enables the vertical angle and the distance to be measured.

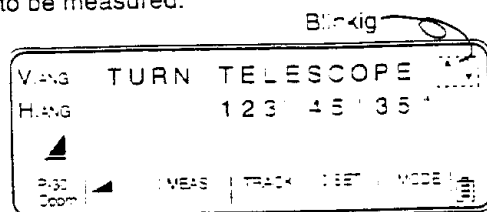

- \* When 2-axis or 3-axis correction is being carried out, the horizontal angle is not displayed until the 0 point for the vertical circle is set (see "Initial Settings" on page 57).
- \* The horizontal angle displayed when the power is turned on is the angle previously displayed when the power was turned off. To reset the angle to 0, press the [0 SET] key twice in succession.

## Indexing the vertical 0 point

With this instrument, the 0 point, which will be used as the reference point for measuring the vertical angle, must be indexed.

This is done by turning the telescope up and down, until the sight axis passes the horizontal position. When the 0 point has been set, the vertical angle (zenith 0 degrees) is displayed.

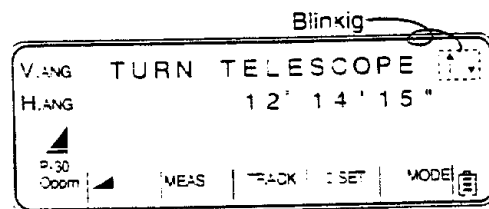
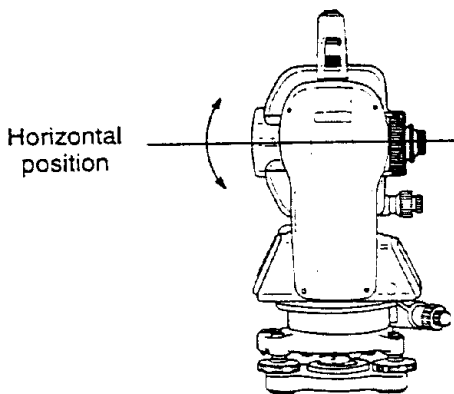

- \* The vertical angle (zenith 0 degrees) can be also changed to the angle of elevation (horizontal 0 degrees) or compass ( $\pm$  from horizontal 0 degrees). (See "Initial Settings B" on page 55.)

## Adjusting the contrast of the LCD

The contrast of the LCD can be adjusted as necessary, at any point.

- 1 Pressing the [↑] key while holding down the [ILLUMINATION] key changes the screen to the LCD contrast adjustment screen.

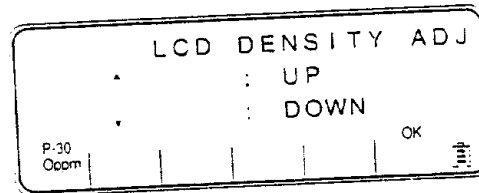
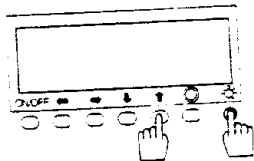

- 2 The contrast can be increased by pressing the [↑] key and lessened by pressing the [↓] key.

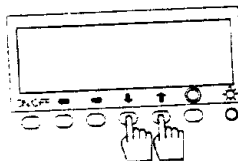

- 3 Press [OK] to conclude the adjustment and return to the original screen.

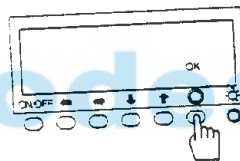

## Adjusting the brightness of the illumination

The brightness of the LCD illumination can be adjusted as necessary, at any point.

- 1 Pressing the [↓] key while holding down the [ILLUMINATION] key changes the screen to the illumination brightness adjustment screen.

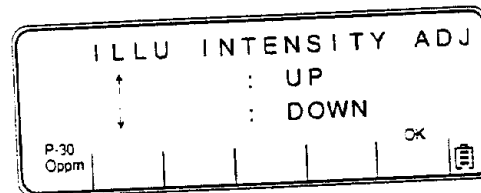
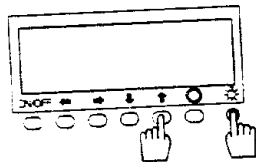

- 2 The brightness of the LCD illumination can be increased by pressing the [↑] key and decreased by pressing the [↓] key.
- 3 Press [OK] to conclude the adjustment and return to the original screen.

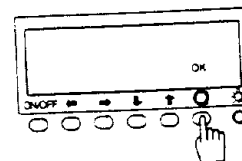
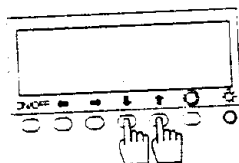

\* The illumination of the LCD is linked to the illumination of the reticle in the telescope, so increasing the brightness of the LCD screen will make the reticle brighter as well.

## Measuring a horizontal angle

- 1 Sight the first target. (If necessary, read the vertical angle.)
- 2 Press the [0 SET] key twice in succession, to reset the displayed horizontal angle to 0° 00' 00".

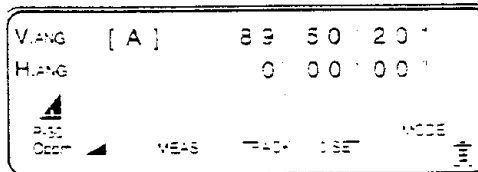
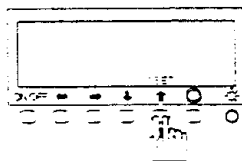

- 3 Sight the second target, and read the angle.

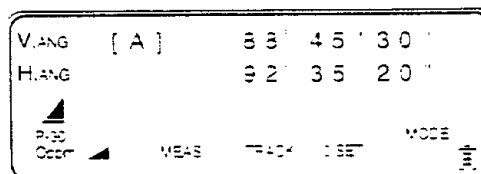
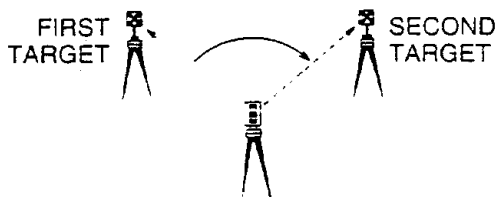

- \* If the initial setting is the "AUTO MEAS" mode and the prism is the target, the distance will be measured automatically, and the distance measurement will be displayed on the third line of the display.
- \* The horizontal angle stays in the memory even if the power is turned off. When the power is turned on again, the same horizontal angle is recalled.
- \* There are three items which can be selected as the 0 reference point for the vertical angle: zenith 0 degrees (vertical angle), horizontal 0 angle (angle of elevation), and percentage slope. (For instructions on setting the 0 reference point for the vertical angle, see "Initial Settings B" on page 55.)

## Resetting the 0 point for the horizontal angle

Press the [0 SET] key twice in succession, to reset the horizontal angle to 0° 00' 00".

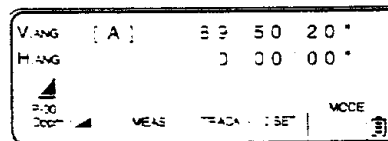
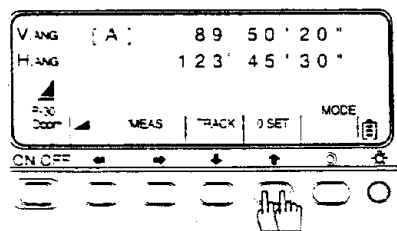

- \* If the [0 SET] key is pressed by mistake during a measurement, nothing will happen. The key has to be pressed twice in succession in order for the 0 point to be reset. If the key has been pressed accidentally, wait for the beeping to stop, and then proceed.
- \* The vertical angle cannot be reset EVEN using the [0 SET] key.

## Horizontal angle hold

The horizontal angle hold is available in the [B MODE].

- Using the [MODE] key, change the screen to the [B MODE].

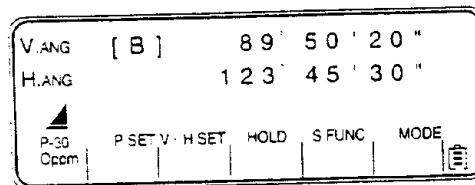
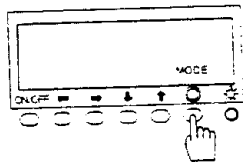

- Press the [HOLD] key twice in succession to hold the displayed horizontal angle and retain it.

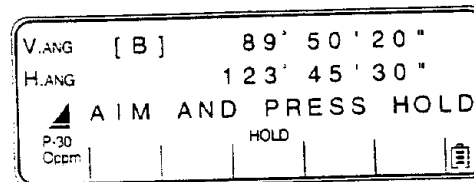
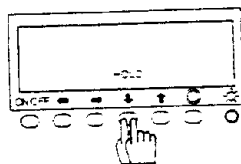

- To cancel the hold, press the [HOLD] key once again. When the hold status is cancelled, the screen returns to the [A MODE] screen.

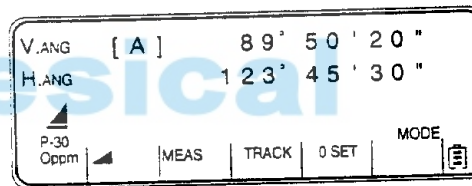
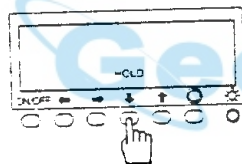

- \* If the [HOLD] key is pressed by mistake during a measurement, nothing will happen. The key has to be pressed twice in succession in order for the hold to be effective. If the key has been pressed accidentally, wait for the beeping to stop, and then proceed.
- \* The vertical angle cannot be reset using the [HOLD] key.

## Changing to the counterclockwise horizontal angle

The change to the counterclockwise horizontal angle is done in the [B MODE].

- 1 Using the [MODE] key, change the screen to the [B MODE].
- 2 Using the [V/H SET] key, change the screen to the "Angle Setting Menu" screen.

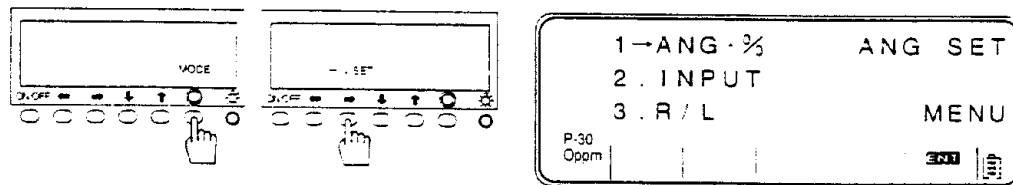

- 3 Press "3" on number keypad to select "3. Right/Left". The horizontal angle is switched to the counterclockwise angle, and the screen returns to the [A MODE] screen.

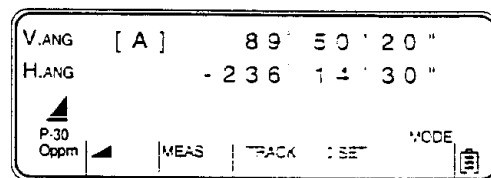
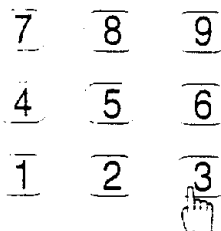

\* At step 3, the [←] and [→] arrow keys can be used instead of pressing the number (3) key to move the cursor to "3. Right/Left". If this method is used, press the [ENT] key to change to the counterclockwise angle.

\* When the angle is changed to the counterclockwise angle, a minus (-) symbol is displayed by the horizontal angle on the second line of the screen.

\* To change back from a counterclockwise to a clockwise angle, use the same procedure to select "3. Right/Left".



## Displaying the % slope of the vertical angle

The [B MODE] is used to display the % slope of the vertical angle.

- 1 Use the [MODE] key to access the [B MODE].

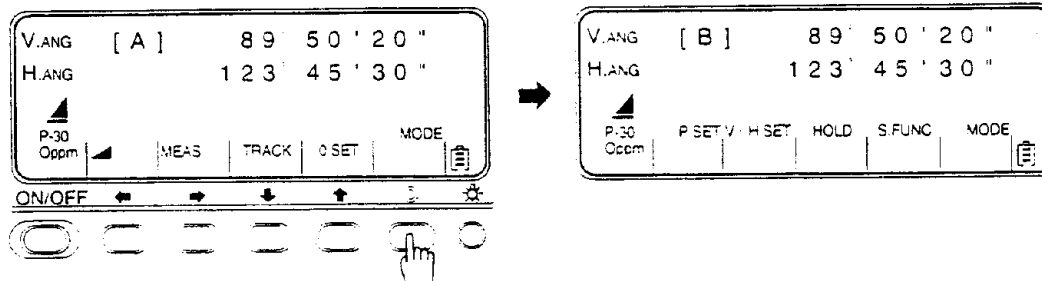

- 2 Using the [V/H SET] key, change the screen to the "Angle Setting Menu" screen.

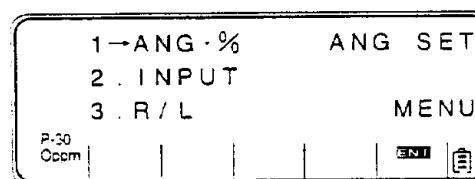
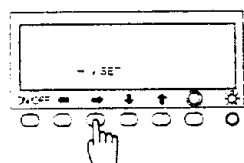

- 3 Press "1" on the number keypad to select "1. Angle - %" and change the vertical angle to a slope (%) display. When the change has been made, the screen returns to the [A MODE] screen.

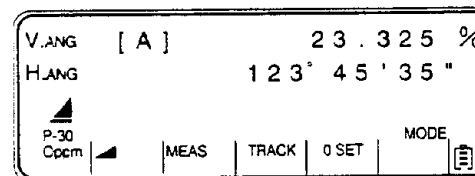
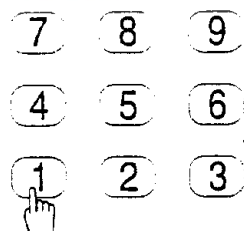

- \* When the screen is changed to a slope (%) display, a "%" mark is displayed at the right edge of the screen.
- \* In step (3), if the cursor is already at "1. Angle - %", simply press the [ENT] key to change to a slope (%) display.
- \* With a slope (%) display, a horizontal is of 0% and 45° is 100%.
- \* To return from a slope (%) display to a usual scale display, use the same procedure to select "1. Angle - %".

## Normal distance measuring

Sight the prism set at the target point and press the (MEAS) key to display the distance on the third line of the screen.

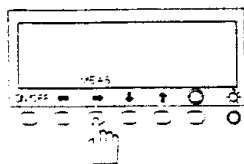

V. ANG	[ A ]	89' 50' 20"
H. ANG		0' 00' 00"
		1 2 3 4 . 5 6 7 m
PRISM	MEAS	TRACK
MODE		

- \* Pressing (MEAS) key after sighting the prism initiates the shot measurement in normal distance measuring, and the characters of (MEAS) start flashing.  
In the shot measurement, distance measurement is finished and the (MEAS) stops flashing once the measured distance value is displayed. Pressing (MEAS) again, during flashing, changes the measurement mode to the continuous measurement.  
(MEAS) continues to flash during the continuous measurement. Pressing (MEAS) again, finishes the measurement, and flashing stops.
- \* Either "1 mm(.005ft.)" or "0.1mm(.0005ft.)" can be selected as the minimum display unit for the normal distance measuring in "Initial Settings B").
- \* The displayed distance changes in sequential order from horizontal distance (▲) to vertical distance (▲) to slope distance (▲) each time the (▲) key is pressed. (The order in which "vertical distance" and "Slope distance" are displayed can be changed using "Initial Settings B".)
- \* Pressing the (MEAS) key causes the segment characters on the screen to flash. During flashing, pressing the (MEAS) key the first time initiates the shot measurement by the specified number. Pressing it the second time initiates the continuous measurement, and the third times stops the measurement.
- \* The segment characters of (MEAS) stops flashing in the shot or continuous measurements when the measured distance value is displayed.
- \* Pressing the (ESC) key or the (MODE) key during measurement interrupts the measurement
- \* Pressing the (TRACK) key during normal distance measurement initiates "Fast measurement", and pressing the (MEAS) key during fast measurement restores normal measurement.
- \* If the number of shots has been set as 2 or more under "Initial Settings B", measurement is carried out for the specified number of times, and the averaged value is displayed at the end. (See "Initial Settings B" on page 55.)
- \* If (AUTO MEAS) has been selected under "Initial Settings B", it is not necessary to press (MEAS) key to start measurement. As soon as the prism is sighted, distance measurement begins automatically. See page 55 for "Initial Settings B".

## Fast distance measuring

Sight the prism set at the target point and press the (TRACK) key to display the distance on the third line of the screen.

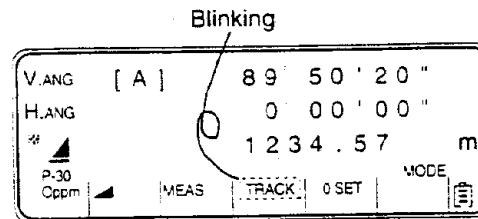
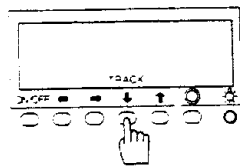

- \* Pressing (TRACK) key after sighting the prism initiates the continuous measurement in fast distance measuring, and the characters of (TRACK) start flashing. (TRACK) continues to flash during the measurement. Pressing (TRACK) again changes the measurement mode to the shot measurement in fast distance measuring. In the shot measurement, the distance measurement is finished and the flashing stops once the measured distance value is displayed. The measurement can also be finished by pressing (TRACK) even while it flashes.
  - \* Either "1 mm(.005ft.)" or "1cm(.05ft)" can be selected as the minimum display unit for the fast distance measuring in "Initial Settings B".
  - \* The displayed distance changes in sequential order from horizontal distance (▲) to vertical distance (▲) to slope distance (▲) each time the (▲) key is pressed. (The order in which "vertical distance" and "Slope distance" are displayed can be changed using "Initial Settings B".)
  - \* Pressing the (TRACK) key causes the segment characters on the screen to flash. During flashing, pressing the (TRACK) key the first time initiates the continuous measurement. Pressing it the second time initiates the shot measurement, and the third times stops the measurement.
  - \* The segment characters of (TRACK) stops flashing in the shot or continuous measurements when the measured distance value is displayed.
  - \* Pressing the (ESC) key or the (MODE) key during measurement interrupts the measurement.
  - \* Pressing the (MEAS) key during fast distance measurement initiates "Normal measurement", and pressing the (TRACK) key during normal measurement restores fast measurement.
  - \* If the number of shots has been set as 2 or more under "Initial Settings B", measurement is carried out for the specified number of times, and the averaged value is displayed at the end. (See "Initial Settings B" on page 55.)
  - \* If (AUTO MEAS) has been selected under "Initial Settings B", it is not necessary to press (TRACK) key to start measurement. As soon as the prism is sighted, distance measurement begins automatically.
- See page 55 for "Initial Settings B".

## Selecting the mode

The PTS-V Series is provided with numerous different functions. In order to keep operation simple, however, functions are divided into two modes. Basic functions such as distance and angle measurement are found in the [A MODE], while the [B MODE] is used for various types of correction and application program.

### Switching Modes

The [MODE] key is used to change from one mode to the other.

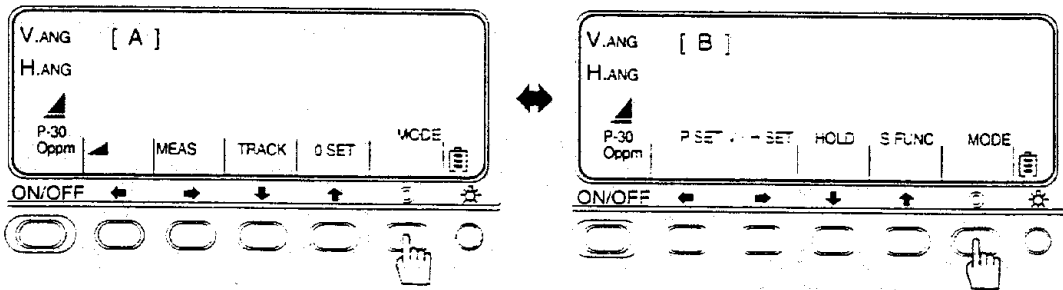

### Roles of Function Keys in A MODE

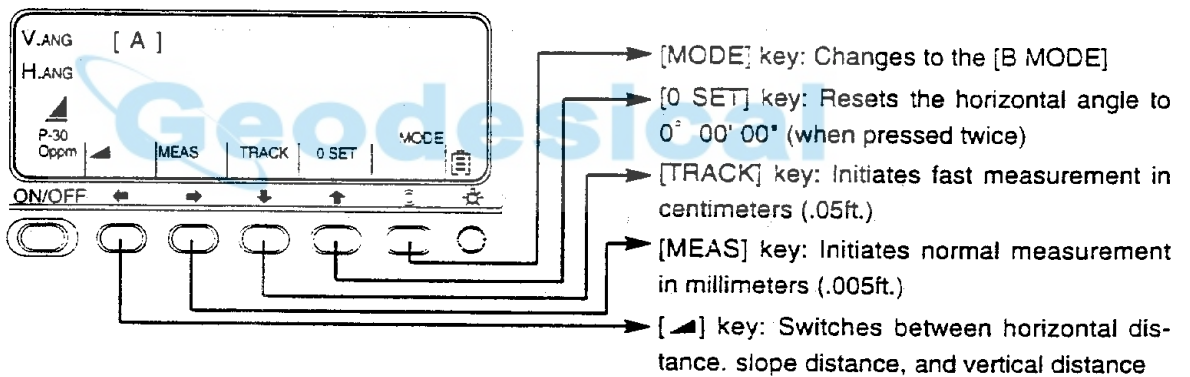

### Roles of Function Keys in B MODE

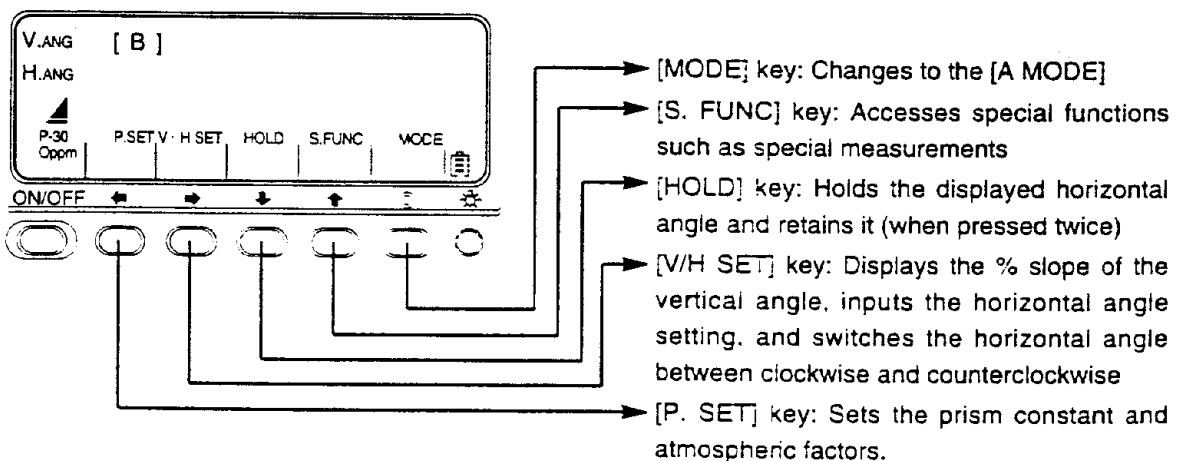

## Selecting the menu

To select the necessary menu from among the several menus displayed on the screen, press the associated menu number on the number keypad.

**Example: To select "2. Input":**

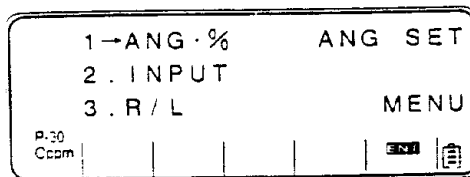

Press the keypad (2) and then the [ENT] key. The screen changes to the "Input Function" screen for the horizontal angle.

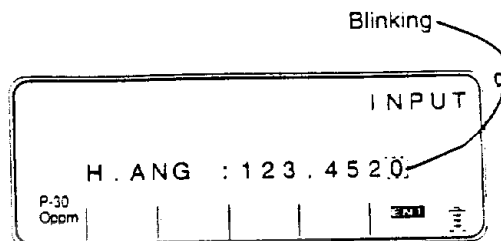
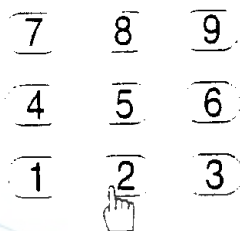

- \* Use the keypad (1) to select "1. Angle - %", or the keypad (3) to select "3. Right/Left".
- \* Instead of the keypads, the [↓] and [↑] arrow keys on the keyboard can be used to move the cursor to the target item (in the example given above, the cursor would be moved to "2. Input", and the [ENT] key pressed to select the item).

## Correction functions (inputting prism constants, temperature, and air pressure)

Correction functions are handled in the [B MODE].

### Example: Changing a prism constant to 0

- 1 Using the [MODE] key, switch to the [B MODE].
- 2 Using the [P. SET] key, change the screen to the "Correction Menu" screen.

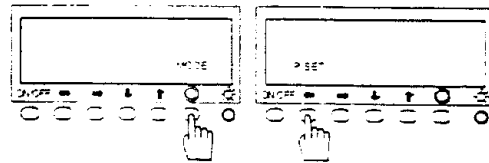

Blinking

PRSM	:	30	mm
TEMP	:	15	°c
PRES	:	760	mmHg
P-30	Coord		

- 3 Press the [CLR] key to clear the displayed data.

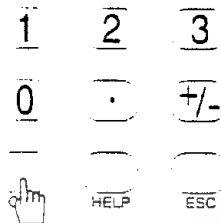

Blinking

PRSM	:		mm
TEMP	:	15	°c
PRES	:	760	mmHg
P-30	Coord		

- 4 Press the keypad(0) to set the prism constant to "0".

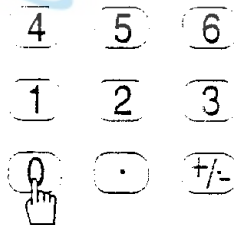

Blinking

PRSM	:	0	mm
TEMP	:	15	°c
PRES	:	760	mmHg
P-30	Coord		

- 5 Press the [ENT] key to enter the prism constant as "0". The cursor moves to the "Temperature" on the second line.

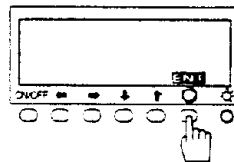

Blinking

PRSM	:	0	mm
TEMP	:	15	°c
PRES	:	760	mmHg
P-30	Coord		

- 6 Use the same procedure to change the temperature setting (if change is not necessary, don't enter anything), and press the [ENT] key to move the cursor to the "Air Pressure" item on the third line.
- 7 Use the same procedure to change the air pressure setting (if change is not necessary, don't enter anything), and press [ENT] key to conclude the settings. The screen changes to confirmation screen of the settings.

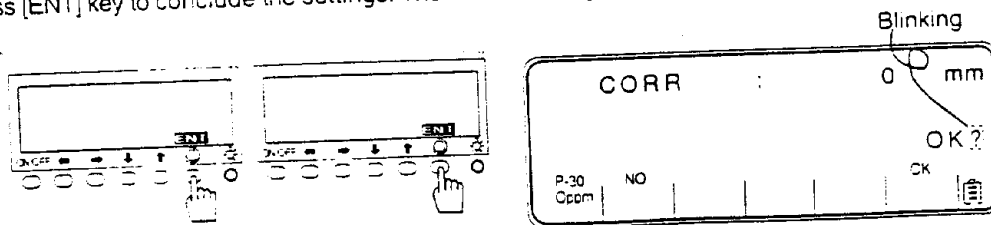

- 8 Verify the PPM, and then press [OK] to move back to the [A MODE].

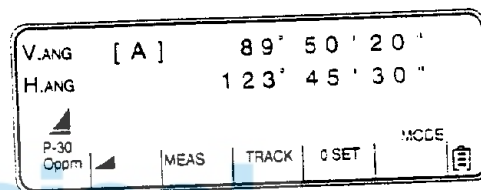

- At step 3, the [→], [←], [↑] and [↓] arrow keys can be used to move the cursor directly to a specific digit to be changed, without first clearing all of the values on the screen. The keypad is then used to change the value set for that specific digit.
- If the [ESC] key is pressed instead of the [OK] key at step 8, the screen returns to the "Correction Menu" at step 2 without entering any changes for the values.
- When data with a negative value (for example, a temperature of -10°C) is input, press the [+/-] key either before inputting the value with the keypad, or right after the value is input.
- If the data is a positive value, the [+] mark is not displayed.
- The ranges of values that can be input for the various correction functions are as follows:
 

Prism const	-99 mm to +99 mm
Temperature	-30°C to +60°C or -22°F to +140°F
Air pressure	600 hPa to 1120 hPa or 420 mmHg to 840 mmHg or 16.5inHg to 33.0inHg
- The input data stored in the memory is retained even if the power is turned off.
- If the following message is displayed for a correction function, it means that the input value cannot be revised (see "Initial Settings A" on page 54).
 

Prism	FIXED
Temperature	FIXED, AUTO or INVALID
Air pressure	FIXED, AUTO or INVALID

## Inputting data

Data is input in the [B MODE].

**Example: Setting a horizontal angle of 123° 45' 20"**

- Using the [MODE] key, change the screen to the [B MODE] screen.

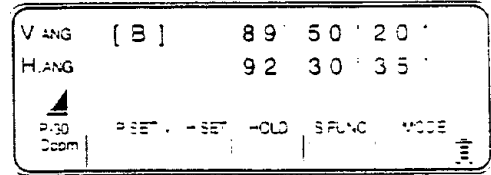
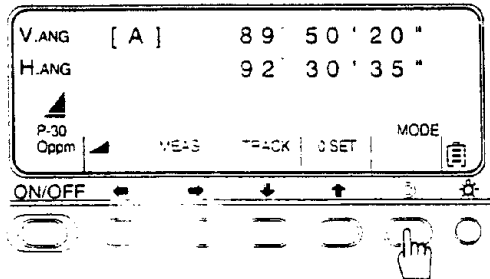

- Using the [V/H SET] key, change the screen to the "Angle Setting Menu" screen.

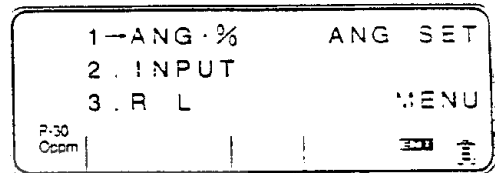
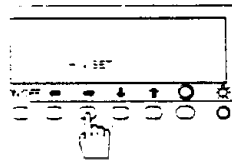

- Using the keypad(2), select "2. Input" to change the screen to the "Input Mode" for the horizontal angle.

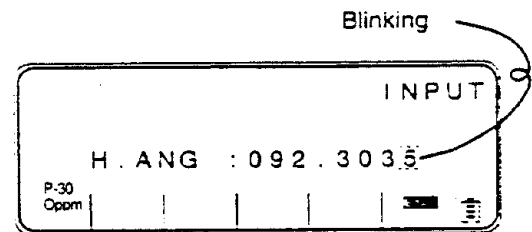
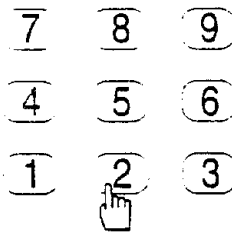

- Press the [CLR] key to clear the displayed data for the horizontal angle.

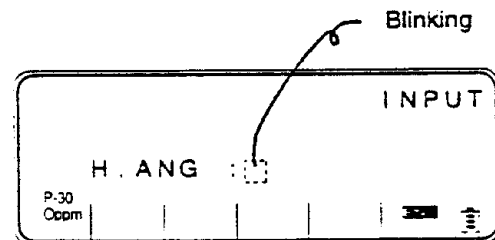
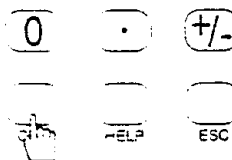



5 Press the following number keys: [1] [2] [3] [.] [4] [5] [2] [0] to specify a horizontal angle of "123.4520".

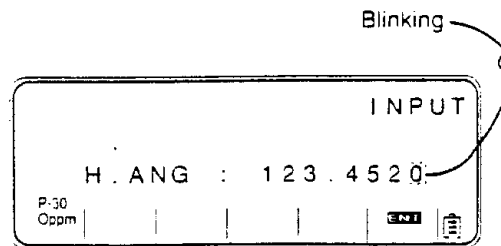
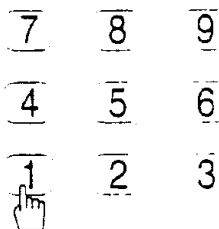

6 Press the [ENT] key to confirm and store the horizontal angle of 123° 45' 20". The screen returns to the [A MODE] screen.

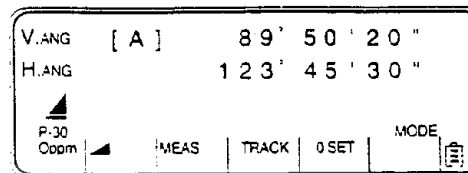
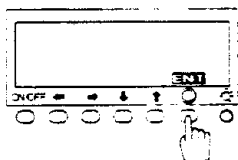

- \* To set a horizontal angle of 123° 45' 20" in step 5, enter as 123.4520, with the decimal point placed where the degree mark would be, to separate minutes and seconds.
- \* At step 3, instead of using the keypad to specify a menu item, the [↓] and [↑] arrow keys can be used to move the cursor to the item (in this case, "2. Input"), and then the [ENT] key pressed to change to the "Input Mode" for the horizontal angle.
- \* At step 4, the [←] and [→] arrow keys can be used to move the cursor to the numeric value to be changed, and the keypad used to revise that value, instead of clearing all of the data on the screen.
- \* When the [ENT] key is pressed on the last item (if there is only one line of data, this will be the first line, and if there are three lines, it will be the third line), all of the values on that screen are stored, and the screen changes.
- \* If the [CLR] key is pressed by mistake, thus clearing the displayed data, pressing the [CLR] key once more before pressing any other key will restore the displayed data.

## Direct access to functions

The PTS-V Series is provided with a special function called a "007" code, which lets initial settings (such as changes in prism constants and priority modes) and application programs (such as coordinate stake-out measurement and traverse measurement) be accessed easily, without complex key operations.

- 1 On the [A MODE] or [B MODE] screen, press the [0] [0] [7] in consecutive order to display the "Command Input" screen.

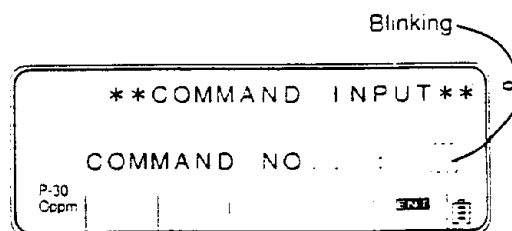
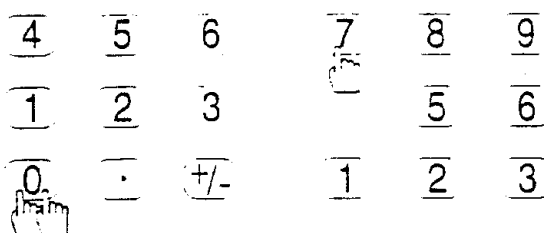

- 2 Next, use the keypad to specify the command number of the desired item, from the "Command No. Table". (For coordinate stake out, this will be [1] [0] [9].)

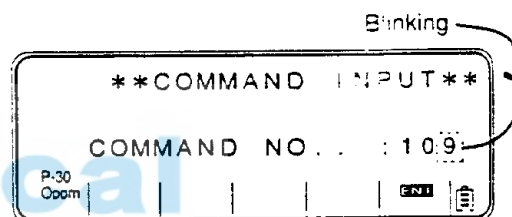
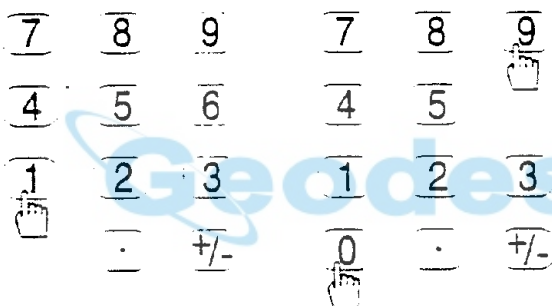

- 3 Press the [ENT] key to call up the coordinate stake out function from among the "Special Functions".

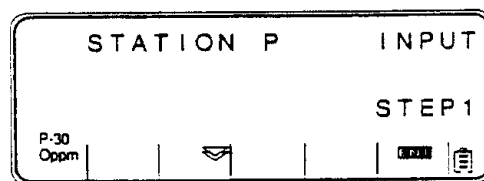
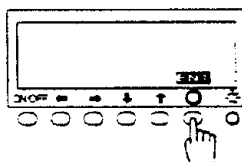

\* All of the items on the "Command No. Table" can be accessed directly, using the same procedure.

## Command No. Table

### Special Functions

Program Name	Command No.
Distance Stake-out	101
Leveling	102
RDM	103
Coordinates	104
Offset Point	105
Lot Staking	106
Inverse Azimuth Distance	107
Traverse	108
Coordinate Stake-out	109
H. Angle Repeat	110
3D Cross Section	111
REM	112
Resection	113
Direct Stake Check	114
Remote Stake Check	115
Offset Station	116
Area	117
Scaling	118

### Initial Settings

Item	Command No.
------	-------------

#### Settings A

Selection of constant	401
PPM correction	402

#### Settings B

Distance	Selection of minimum reading	501
	Selection of number(s) of shots	502
	Selection of atmospheric compensation	503
Angle	Selection of minimum reading	504
	Selection of V angle mode	505
	Retention of H angle	506
Beep	Beep volume	507
	Beep in measurement on/off	508
	90° Beep on/off	509
Power setting	Auto power OFF	510
	Auto EDM power OFF	511
	Auto illumination OFF	512
Operation	Title display YES/NO	513
	EDM symbol YES/NO	514
	Preferential mode	515
	XYZ - NEZ	516
	V. angle compensator ON/OFF	517

#### Settings C

Quick set	601
Tool kit	602
Grouping program	603

#### Settings D

Selection of angle unit	701
Selection of distance unit	702
Selection of temperature and air pressure units	703

#### Settings E

Communication parameters	801
--------------------------	-----

**Help function**

If you are not sure what to do next during an operation, press the [HELP] key. This displays the operation procedure on the screen.

**Example: Using the [HELP] key in the angle setting function**

1 When the [HELP] key is pressed during the "Angle Setting Function", the function currently being carried out is displayed as "\* Status".

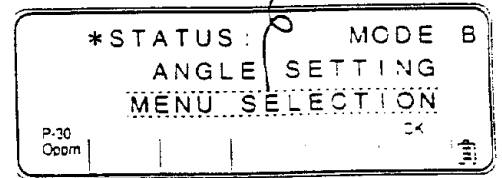
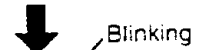
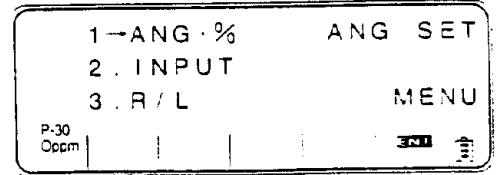

2 Press the [OK] key. The screen will display instructions on what to do next, under the heading "\* GUIDE".

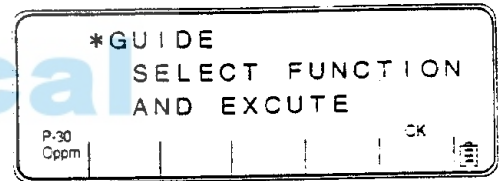
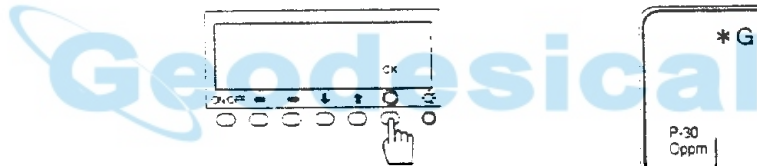

3 Press [OK] once again to display the item to be selected.

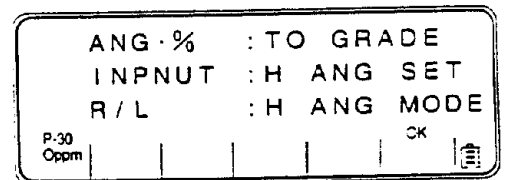
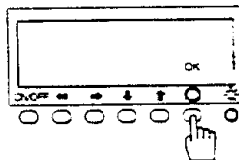

4 Pressing the [OK] key once again displays the key operation procedure under the heading "\* OPERATION".

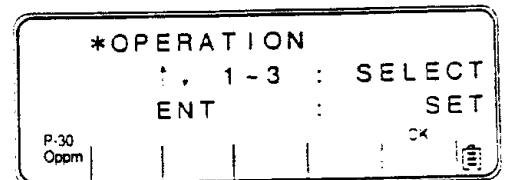
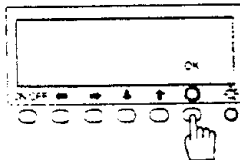

- 5 Select the key operation procedure (using the [↑] or [↓] key to select item 1, 2, or 3), or press the [ENT] key. A confirmation message is displayed, asking if it is all right to enter the item at the cursor position. Press [OK] to display the explanation screen for the [ESC] key.

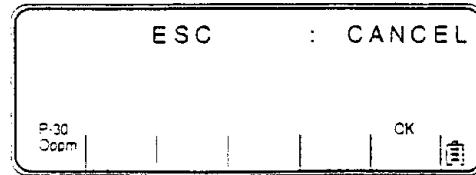
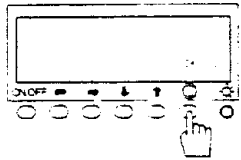

- 6 Pressing [OK] exits the Help function and returns the screen to the "Angle Setting Function" screen. Select the item confirmed in step 1.

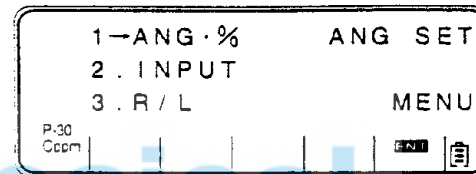
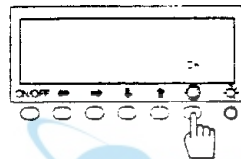

\* Pressing the [ESC] key on any screen interrupts the function at that point and returns the screen to the one displayed previously to that function.

## Group selection

The PTS-V Series comes complete with 18 different application programs. These are divided into five groups, based on the surveying application. One of these groups can be selected and registered in the "Tool Kit" (the kit in which programs are registered). (When the instrument is shipped from the factory, "Type 1" is registered.)

Registration and settings for groups are done under "Initial Settings C".

### Example: Changing the group type from "Type 1" to "Type 2"

- 1 Turn on the power supply while holding down the [↓] key, to access 'Initial Settings C'.
- 2 Use the number "3" to select "3. GROUP", the screen changes to the 'CHECK/SET' screen.

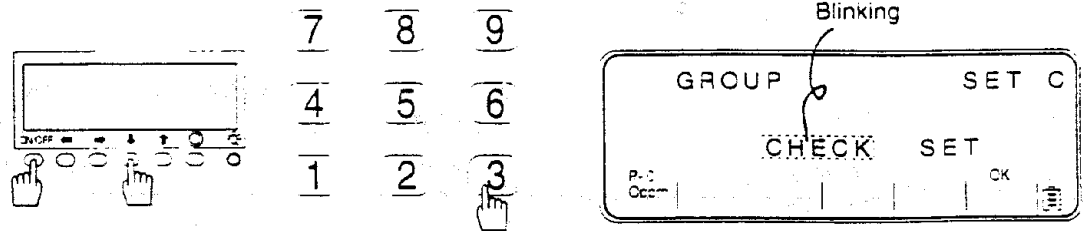

- 3 Using the [→] key, move the cursor to the "Setting" item.



- 4 Press [OK] twice in succession. This brings up the setting screen, and displays the message "Type: 1 2 3 4 5". (In the diagram of this example, the cursor is positioned at "1", indicating that "Type 1" is registered.)

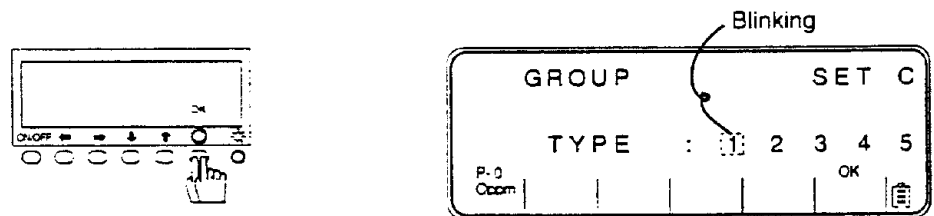

- 5 Using the [→] key, move the cursor to "2".

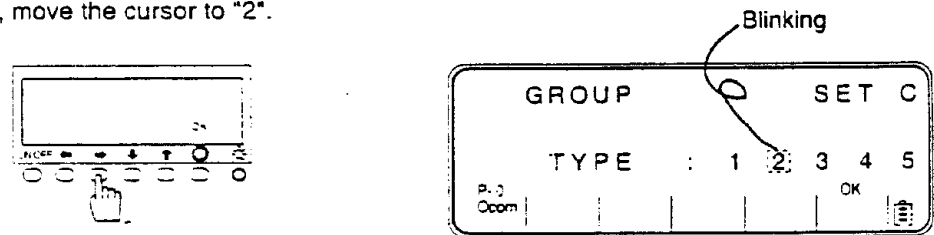

6 Press the [OK] key to register "Type 2" in the tool kit. The screen returns to the menu under "Initial Settings C".

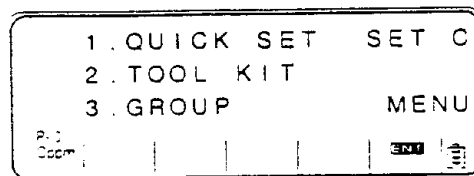
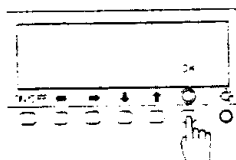

- \* At step 2, the [↑] or [↓] key could also be used to move the cursor to "3. GROUP", instead of using the keypad. Pressing the [ENT] key would then change the screen to the "GROUP" screen. (If the cursor is already positioned at the target item "3. GROUP", simply press the [ENT] key.)
- \* If the [ESC] key is pressed during the setting procedure, the screen returns to the menu under "Initial Settings C" without changing the setting (Type 1).
- \* When the group type is changed, all of the contents registered in the tool kit are deleted, and the new type of group is registered.
- \* The contents of a group program registered in the tool kit can be changed freely as long as they are in the tool kit. (See "Registering Group in Tool Kits" on page 38.)

### Contents of the Group Program Types

Type	Contents of Group Program
Type 1:	RDM, Area, Offset Point Coordinate Stake-out, Resection, Traverse
Type 2:	RDM, Distance Stake-out, Lot Staking Coordinate Stake-out, Resection, Offset Station
Type 3:	Distance Stake-out, Offset Point, Lot Staking Inverse Azimuth/Distance, Traverse, Area
Type 4:	Leveling, Inverse Azimuth/Distance, Traverse Direct Stake Check, Remote Stake Check, Scaling
Type 5:	Coordinate Stake-out, Traverse, Resection Direct Stake Check, Remote Stake Check, Scaling

## Registering groups in the Tool Kit

In order to use these 18 different types of application programs efficiently, the user can select the six programs which are used most frequently, and can substitute these for the group programs in the tool kit. Groups are registered in the tool kit using "Initial Settings C".

- 1 Turning on the power while holding down the [↓] key brings up the "Initial Settings C" menu.

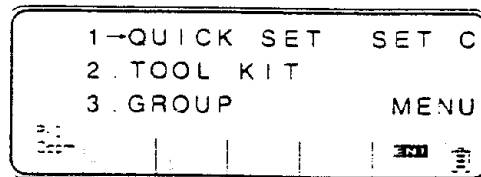
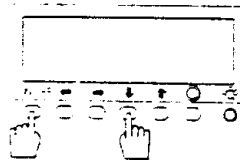

- 2 If the number "2" keypad is used to select '2. Tool Kit', the screen changes to the 'CHECK/SET' screen.

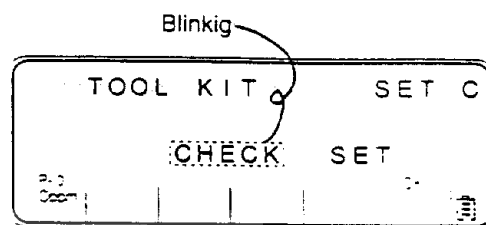
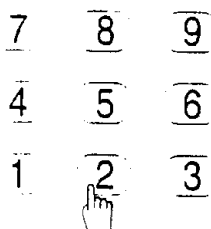

- 3 Using the [→] key, move the cursor to the "Setting" item.

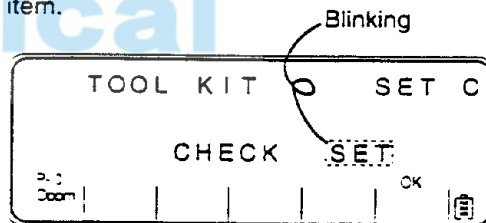
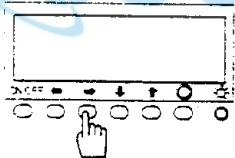

- 4 Press [OK] twice in succession. This brings up the Registration Menu No. 1 screen.

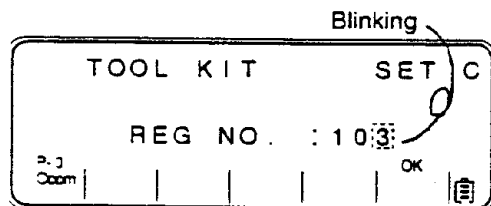
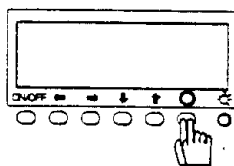

- 5 Press the [CLR] key to delete any command numbers already registered.

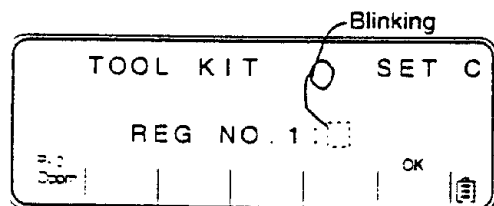
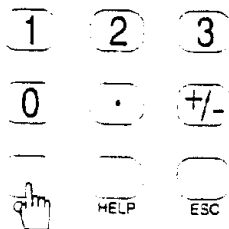



6 Using the number keypad, specify the command number of the application to be registered. (As an example, we will specify "106", Lot Staking)

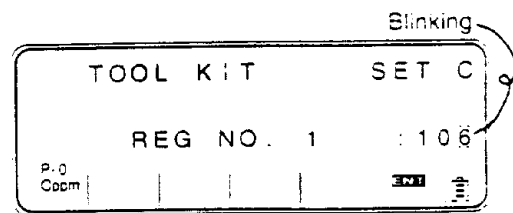
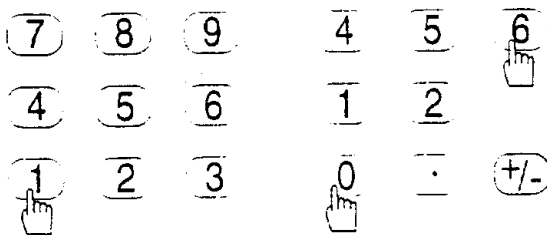

7 Press the [ENT] key to store the specified command number. The registration menu changes to the No. 2 menu.

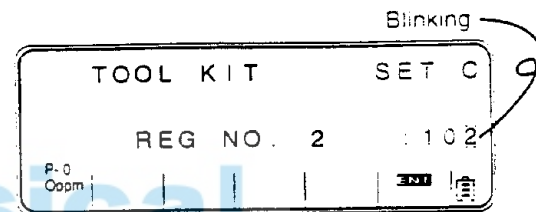
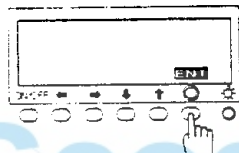

8 Continue repeating the [CLR], [SET] and [ENT] steps until you reach Registration Menu No. 6. When the [ENT] key is pressed on Menu No. 6, the screen returns to the "Initial Settings C" screen.

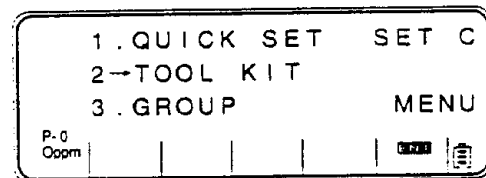
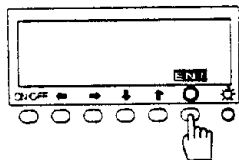

- At step 2, the [↓] key could also be used to move the cursor to "2. Tool Kit", instead of using the keypad. Pressing the [ENT] key would then change the screen to the "CHECK/SET" screen.
- At step 5, the [←] and [→] arrow keys can be used to move the cursor to the number value to be changed without clearing the command number. Use the keypad to change only the value for that particular setting.
- To avoid deleting a program which has already been registered, simply press the [ENT] key. This leaves the function intact and advances to the next screen. For more detailed information on the Tool Kit function, please refer to page.

## Special functions

The PTS-V Series comes with 18 different application programs which make surveying operations easier and more efficient. These include Distance Stake-out, Leveling, RDM, Coordinates, Offset Point, Lot Staking, Inverse Azimuth/Distance, Traverse, Coordinate Stake-out, H. Angle Repeat, 3D Cross Section, REM, Resection, Direct Stake Check, Remote Stake Check, Offset Station, Area, and Scaling measurements. These programs are referred to as "special functions." Any data input to these programs is retained in the memory when the power is turned off, and data which is shared with other programs can be used in common.

## Accessing the Special Functions

Using the [MODE] key, bring up the [B MODE] screen, and then press the [S. FUNC] key twice in succession to access the special functions.

### Example: Accessing the Coordinate Stake-out Function

- 1 Press the [MODE] key to access the [B MODE].
- 2 Press the [S. FUNC] key twice in succession to access the special functions.

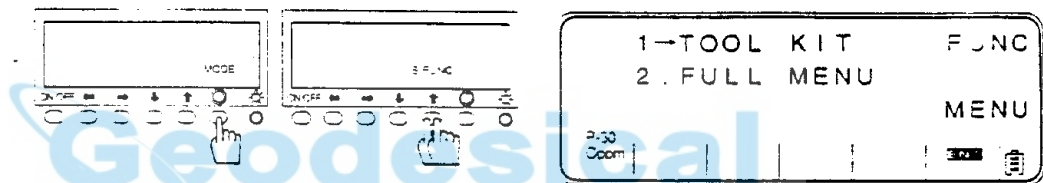

- 3 Press the number (2) keypad to select "2. Full Menu". This displays the menu screen where the special measurement functions can be selected.

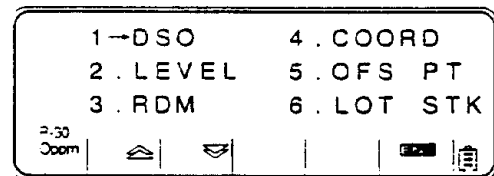
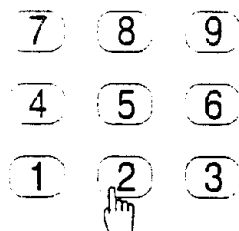

- 4 "Coordinate Stake-out" is not displayed on this screen, so press the [↵] key to go to the next screen.

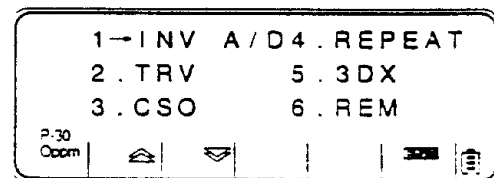
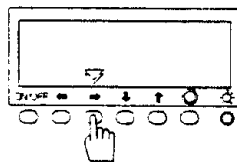

- 5 Use the number (3) keypad to select "3. Coordinate Stake-out". This brings up "Step 1" of the Coordinate Stake-Out measurement function.

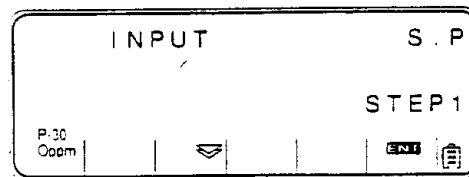
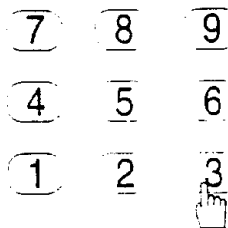

- \* At step 2, if "Coordinate Stake-out" has been registered in the Tool Kit, select "1. Tool Kit" using the number (1) keypad.
- \* For the "Item Selection" at steps 3 and 5, the [↑] and [↓] keys can be used instead of the number keypad, to move the cursor to "2. Full Menu". Then press the [ENT] key to change the screen to the special measurements menu. (If the cursor is already positioned on "2. Full Menu", simply press the [ENT] key.)
- \* All of the special function programs can be accessed directly by code numbers, without going through the above process. (See "Accessing Functions Directly" on page 32.)

Geodesical

## Measurement with the coordinate stake-out function

In coordinate stake-out measurement, coordinates can be staked out in three dimensions, based on the instrument coordinates and backsight coordinates which are already known, or on the backsight directional angle and the instrument point coordinates. The horizontal angle to the stake-out point and the horizontal distance are calculated automatically as the design values, and the difference between the calculated values read during measurement is displayed as the deviation. Also, with coordinate stake-out measurement, "s/S compensation" (scaling compensation towards the coordinates of the horizontal plane angle, or scale correction) can be carried out. (For more information on s/S compensation, please refer to page 50.)

### Overall drawing

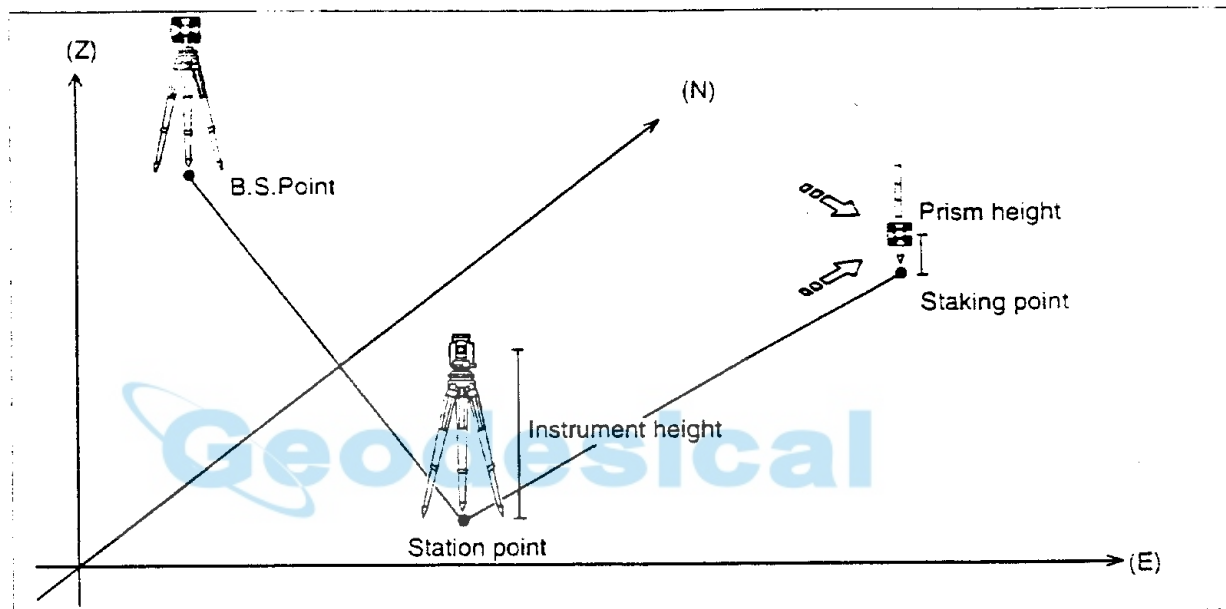

### Design values and deviation

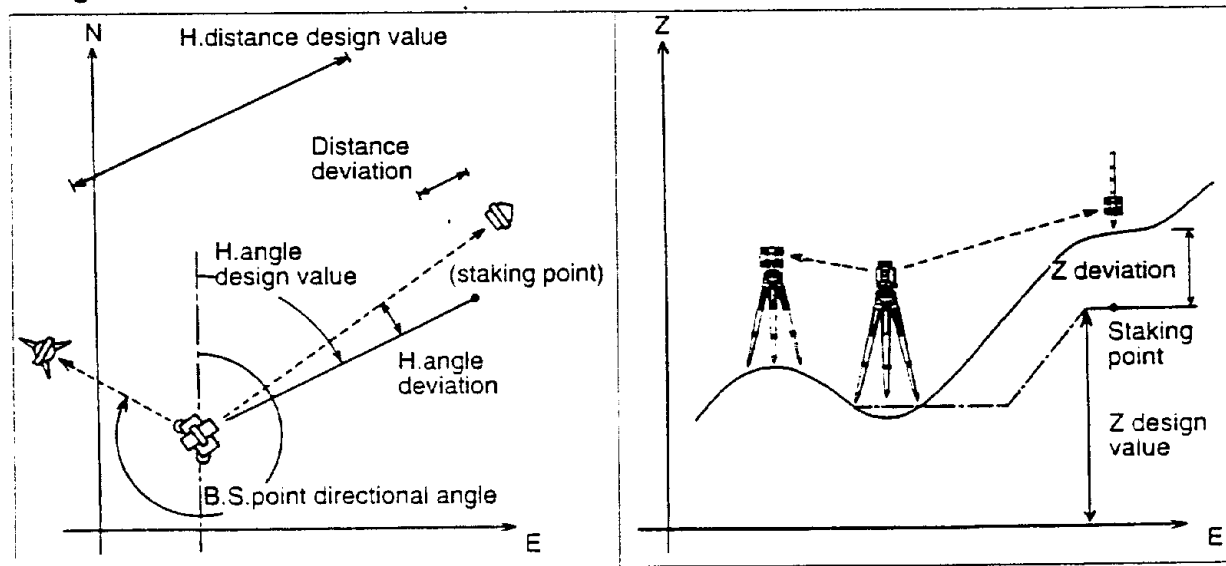

## Operation procedures and operative illustrations

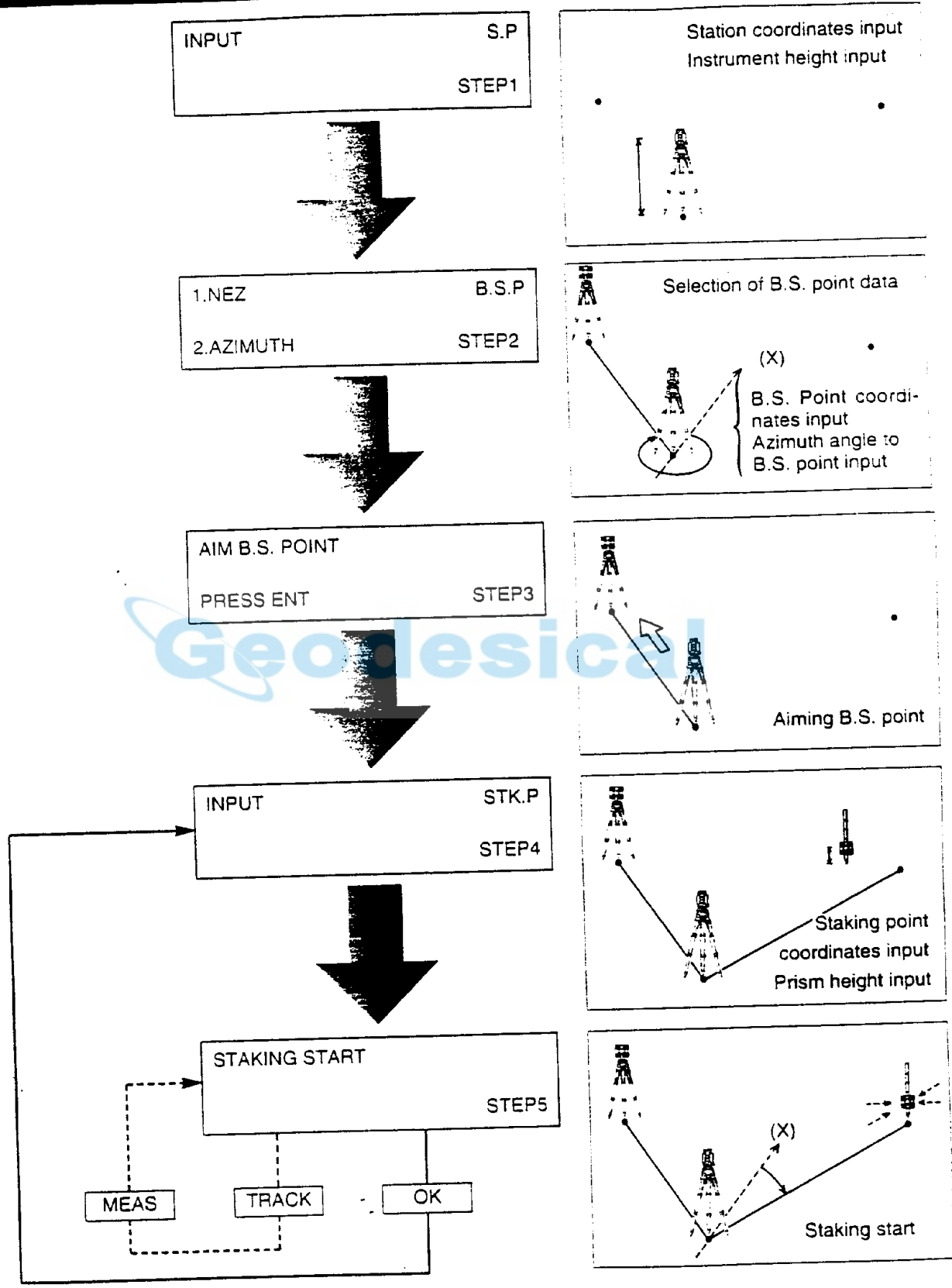

**Step 1****Inputting the Instrument Coordinates (NEZ) and Instrument Height**

- 1 Press the [ENT] key to display the screen where the instrument coordinates "NEZ" are entered.

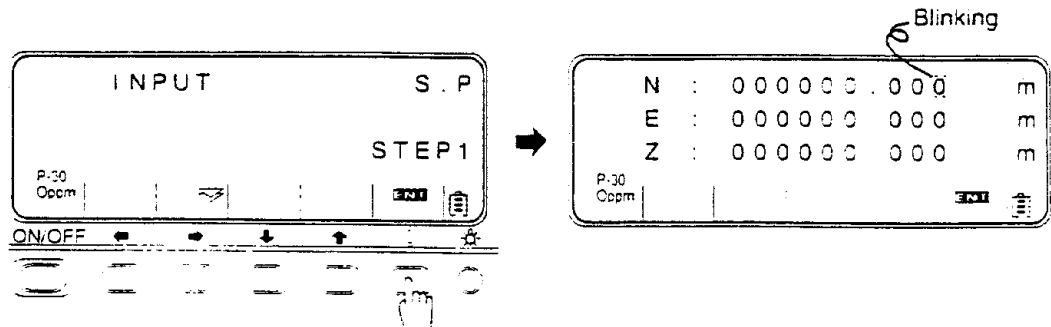

- 2 Press the [CLR] key to delete the "N" data.

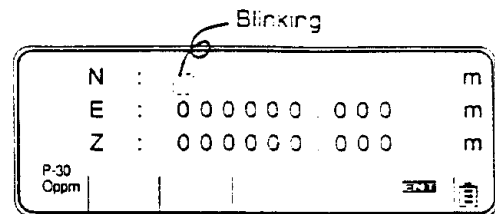
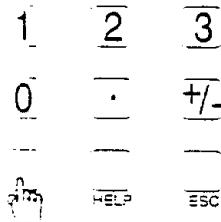

- 3 As an example, let's input a value of "-12345.890". To input the value for coordinate "N", press the numeric keys in the following order: [+/-] [1] [2] [3] [4] [5] [.] [8] [9] [0]. Press the [ENT] key and move the cursor to [E].

Use number keypad to set

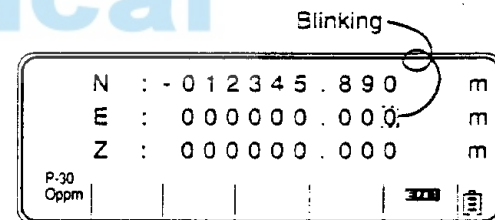
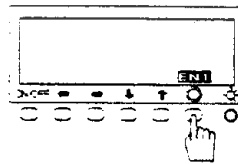

- 4 Set the "E" coordinate in the same way; first press [CLR] to clear the previous setting, and then enter a new value for the instrument coordinate "E" using the numeric keys (in our example, let's use "2345.890"). Then press the [ENT] key to input the setting.

- 5 Finally, repeat the process for the "Z" coordinate, first pressing [CLR] and then using the numeric keys to enter a new value (let's use "-345.891"). Press the [ENT] key to change the display to the screen where the instrument height is input.

CLR → Use number keypad to set

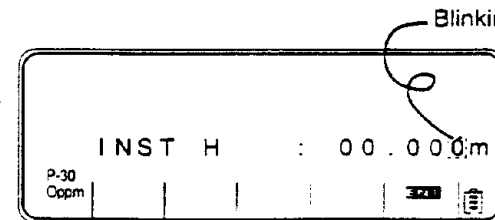
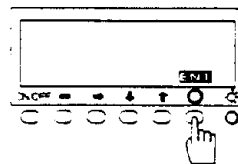

6 In the same way as for the instrument coordinates, press the [CLR] key to delete the previous value. and then use the numeric keys to input the new value (here, let's use "1.526 m"). Pressing the [ENT] key changes the screen to the "Step 2" screen.

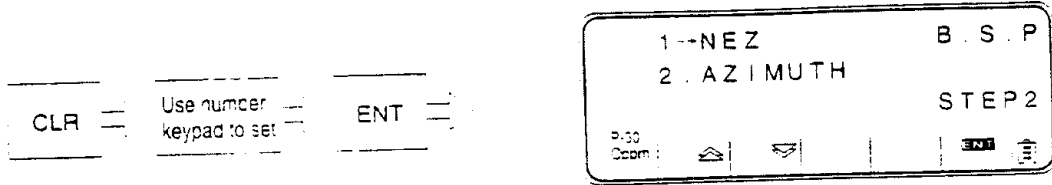

- \* At step 2, the [CLR] key should be pressed to clear the data even if the previous value is "000.000".
- \* At step 5, if there is no need to enter a Z coordinate, leave the data as "000.000", or simply press the [CLR] key and then the [ENT] key. This sets a Z coordinate of "0".

## Step 2 Inputting the Backsight Coordinates or the Backsight Azimuth Angle.

1 As an example, we will select a backsight azimuth angle and input a value of 123° 45' 20". Use the number "2" key to select "2". Azimuth Angle.

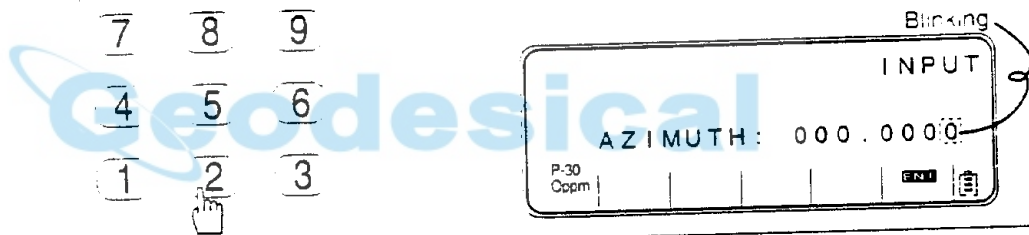

2 Press the [CLR] key to erase the previous data set for "Azimuth Angle", and then, using the numeric keys, input the following value: [1] [2] [3] [.] [4] [5] [2] [0]. This sets the backsight direction angle.

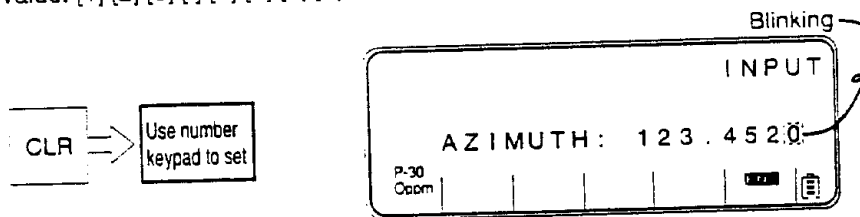

3 Pressing the [ENT] key stores the value and changes the screen to the "Step 3" screen.

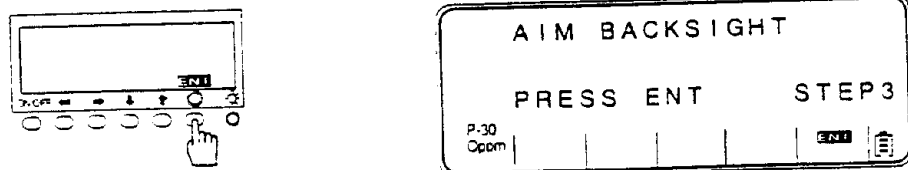



- \* At step 2, the [CLR] key should be pressed to clear the data even if the previous value is "000.000".
- \* In the setting of "123° 45' 20" entered at step 2, a period is used where the degree mark would be, and no separation is made between the minutes and seconds.

**Step 3****Sighting the Backsight Point**

Following the guide messages on the screen, sight the backsight point and press the [ENT] key. The screen changes to the "Step 4" screen.

Sight B.S.  
point



ENT

INPUT		STK P
		STEP 4
P:30 Oppm		 

**Step 4****Inputting the Stake-Out Coordinates (NEZ) and the Prism Height**

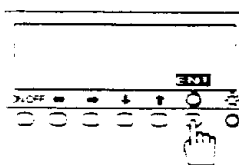
- 1 Press the [ENT] key to bring up the screen where the staking point coordinates "NEZ" are input.





		Banking
N :	000000.000	m
E :	000000.000	m
Z :	000000.000	m
P:30 Oppm		 

- 2 In the same way as for Step 1, enter the data for the N, E, and Z coordinates.

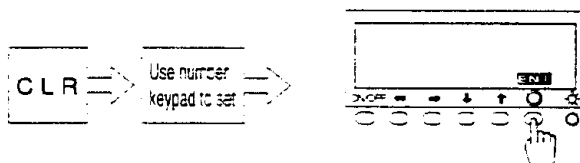
- 3 When the "Z" coordinate data has been entered and the [ENT] key pressed, the screen changes to the prism height input screen.



PRISM H :		00.000 m
P:30 Oppm		 

- 4 Input the prism height in the same way. When the [ENT] key is pressed, the screen changes to the "Step 5" screen.

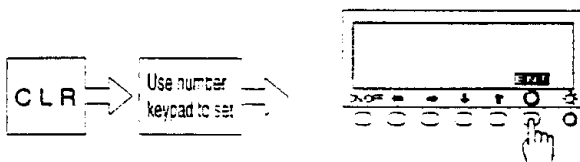

STAKING START		
		STEP 5
P:30 Oppm		 

- \* At step 3, if there is no need to enter a Z coordinate, leave the data as "000.000", or simply press the [CLR] key and then the [ENT] key. This stores a Z coordinate of "0".



## Step 5 Starting Stake-Out Measurement

- 1 Press the [ENT] key to bring up the screen where the value entered for the staking point coordinates can be confirmed. The design values calculated using the data entered in Steps 1 to 4 are displayed on this screen.

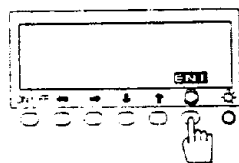

SET VALUE	
H.ANG	123° 45' 50"
	127.972 m
P-30 Occur	OK

- 2 Press the [▲] key to confirm the Z value.

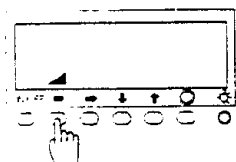

SET VALUE	
H.ANG	123° 45' 50"
Z	12.340 m
P-30 Occur	OK

- 3 Pressing [OK] changes to the horizontal angle setting screen, with the "SET", "ANG" and "DEV" displayed.

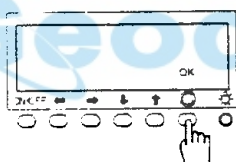

SET :	123° 45' 50"
H.ANG ANG :	65° 43' 20"
DEV :	-58° 02' 30"
P-30 Occur	OK

- 4 Rotate the instrument, using the upper H. motion, until the "DEV" reads "0" (or as close to "0" as possible), and lock the rotation of the horizontal direction of the instrument.

SET :	123° 45' 50"
H.ANG ANG :	123° 45' 50"
DEV :	0° 00' 00"
P-30 Occur	OK

- 5 Press [OK] to move to the distance measurement screen, where "SET", "DST" and "DEV" are displayed.

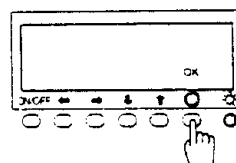

SET :	65.430 m
DST :	0.000 m
DEV :	-65.430 m
P-30 Occur	MEAS TRACK

- 6 Move the prism to the sighting direction of the telescope, and press the [TRACK] key to measure to the prism.

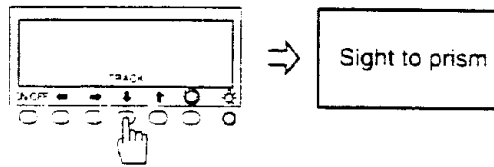

- 7 Move the prism in the direction in which the "DEV" approaches "0".  
 8 .When the "DEV" has come close to "0", press the [MEAS] key to switch to normal distance measurement. Continue measuring until you find the exact point where "DEV" becomes "0". This concludes stake-out of the No. 1 point.

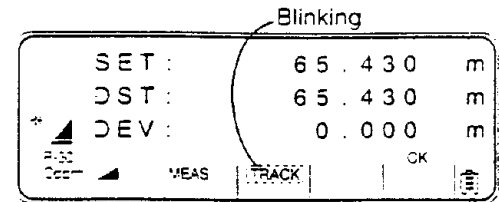
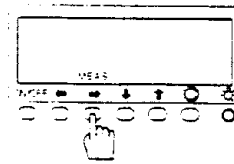

- 9 Pressing the [OK] key takes you back to Step (4). Repeat the process for the No. 2 and No. 3 points if there are any.

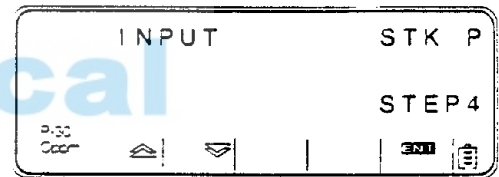
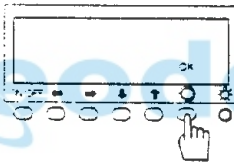

- \* If the smallest angle unit is not set to [1"/2cc display], there may be times when you cannot get a value that is exactly "0".
- \* When tracking the prism in Step 6 , continuous measurement is carried out once the [TRACK] key has been pressed after the general position of the prism has been determined. Using shot measurement with the [MEAS] key is the most efficient way to find the precise position of the prism.
- \* Each time the [▲] key is pressed, the display changes in sequence from "Horizontal Distance" to "Height Z" to "Horizontal Design Value".
- \* Data input using this instrument is retained in the memory when the power is turned off, and all data except the stake-out coordinates can be used in common with other functions.
- \* To exit a special measurement, or to interrupt it and go back to the [A MODE], press the [ESC] key several times, until the screen returns to the [A MODE] screen. (The number of times the [ESC] has to be pressed varies depending on the point at which the key is pressed.)

**Contents of application programs**

18 application programs have the below-mentioned function, respectively.

**1. Distance stake-out function**

With distance stake-out measurement, the difference between the input design values (specified distance) and the distance to the prism is displayed, making it easier to stake a point.

**2. Leveling function**

With leveling measurement, the elevation of the observation point and the horizontal distance to the bench mark and the various observation points can be calculated and displayed by entering the elevation of the bench mark(BM).

**3. RDM function**

With RDM measurement, the horizontal distance, the vertical distance the slope distance and the percentage of slope between the base point and prism at the observation point are measured. The base point can be changed to any desired observation point.

**4. Coordinates function**

With coordinates measurement, the instrument point serves as the datum station, and the coordinates of any desired target point can be determined. Even if the instrument point is not used as the datum station, the coordinate values can be determined from the coordinate datum station by inputting the coordinate values of the instrument point.

**5. Offset point function**

Offset point measurement can be used when the prism can not be positioned because of an obstacle in the way. With this type of measurement, the target coordinates are measured indirectly.

**6. Lot staking function**

With the lot-staking function, the design values for an input distance, or a distance between two points which have already been specified, can be divided into a number (N) or equal segments.

**7. Inverse Azimuth/Distance function**

With inverse azimuth/distance measurement, the azimuth angle and the distance to a backsight point can be calculated and displayed by inputting known instrument point coordinates and backsight point coordinates.

**8. Traverse function**

With traverse measurement, the coordinates of new point can be determined, based on the given "instrument point coordinates and backsight point coordinates" or the "instrument point coordinates and directional angle".

**9. Coordinate stake-out function**

In coordinate stake-out measurement, coordinates can be staked out in three dimensions, based on the instrument coordinates and backsight coordinates which are already known, or on the backsight directional angle and the instrument point coordinates.

**10. H. Angle Repeat measurement**

With the H. angle repeat measurement, the horizontal angle between the No.1 target (P1) and the No.2 target (P2) is measured n number of times, and the cumulative values and averaged values can be determined.

### 11. 3D Cross Section function

With the 3D cross section measurement, prisms are placed at 2 points almost directly below the places to be measured, and these prisms are measured. The coordinates of a perpendicular plane formed along the straight line extending between the two prisms can be determined, so that it is easy to measure the coordinates of locations where prisms cannot be placed directly, such as on the walls of objects being constructed, and sections of tunnels.

### 12. REM function

With REM measurement, a prism (base point) is set directly below the place to be measured, and by measuring this prism, the height to the target object can be measured. This makes it easy to determine the heights of electric power lines, bridge suspension cables, and other large items used in construction.

### 13. Resection function

With the resection function, two known points (Point A and Point B) are measured in order to determine the coordinates of the instrument point.

### 14. Direct Stake Check function

In the direct stake check function, the difference between the design values for a horizontal distance, calculated using inverse calculation from the coordinate values of a known point (Point A) and a target point (Point B), and the horizontal distance actually measured between A and B is displayed.

### 15. Remote Stake Check function

In the remote stake check function, the difference between the design values for a horizontal distance, calculated using inverse calculation from the coordinate values of two known points (Points A and B), and the horizontal distance actually measured between A and B is displayed.

### 16. Offset Station function

With offset station measurement, a PTS set on the center line is used for easy setting of the stake out points to the left and right of the center line.

### 17. Area function

With the area measurement, the area is calculated and displayed in real time as each target point is measured, and the horizontal distance between two prisms is displayed as well.

### 18. Scaling function

"Scaling" as used here refers to scaling and perspective correction carried out as part of the measurement process among the special functions. It is effective only with coordinates stake-out, traverse measurement, inverse azimuth/distance calculation, direct stake check, remote stake check, and resection measurement. Of these, reverse perspective correction is carried out with coordinate stake out, inverse azimuth/distance, direct stake check, and remote stake check.

\* When the unit is shipped from the factory, the correction coefficient is set to "1" and the elevation to "0", so that no correction is carried out. If correction is necessary, input the appropriate values for scaling coefficient and the average elevation.

### Equation of scaling

#### A. Perspective Correction Equation

This equation is used when the on-site slope distance is to be corrected to the distance for the horizontal value angle coordinates:

$$S_b = S_a \left( \frac{R}{R+H} \right)$$

$S_b$ : Horizontal distance (distance on surface of standard oval-shaped object)

$S_a$ : Horizontal distance (distance on surface of actual site)

$R$ : Averaged datum station for radius of earth (6370 km/20,898,906.21ft)

$H$ : Average on-site elevation (input value)

$$S_c = m (S_b)$$

$S_c$ : Horizontal distance (distance between horizontal angle coordinates)

$m$ : Scaling coefficient (input value)

$S_b$ : Horizontal distance (distance on surface of standard oval-shaped object) This horizontal distance  $S_c$  is used to calculate the coordinates.

#### B. Reverse Perspective Correction Equation

This equation is used when the distance between horizontal angle coordinates is being corrected to a horizontal distance on the actual site:

$$S_a = \frac{S_c}{m} \cdot \left( 1 + \frac{H}{R} \right)$$

$S_a$ : Horizontal distance (distance on actual site)

$m$ : Scaling coefficient (input value)

$S_c$ : Horizontal distance (distance between horizontal angle coordinates)

$R$ : Averaged datum station for radius of earth (6370 km/20,898,906.21ft)

$H$ : Average on-site elevation (input value)

### Initial settings

With the PTS-V Series, there are numerous usage conditions which can be selected and specified by the user. These are called "initial settings," and are grouped into five groups (A, B, C, D, and E) depending on the type of condition.

"Initial Settings A" include the setting of prism constants and atmospheric compensations.

"Initial Settings B" include selections such as the distance and angle being measured, the beep sound, cutoff timers, operations, and automatic compensation.

"Initial Settings C" include the selection of functions such as Quick Set, Tool Kit, and Groups.

"Initial Settings D" include selections such as the unit used to express temperature and air pressure.

"Initial Settings E" include selections of communication parameters.

### Accessing the Initial Settings

Turning on the power while holding down the [←] key brings up the "Initial Settings A" screen.

Turning on the power while holding down the [→] key brings up the "Initial Settings B" screen.

Turning on the power while holding down the [↓] key brings up the "Initial Settings C" screen.

Turning on the power while holding down the [↑] key brings up the "Initial Settings D" screen.

Turning on the power while holding down the [⊙] key brings up the "Initial Settings E" screen.

### Entering values into the initial settings

#### Example: Setting the prism constant under "Initial Settings A"

- 1 Turn on the power while holding down the [←] key, to bring up the "Initial Settings A" screen.

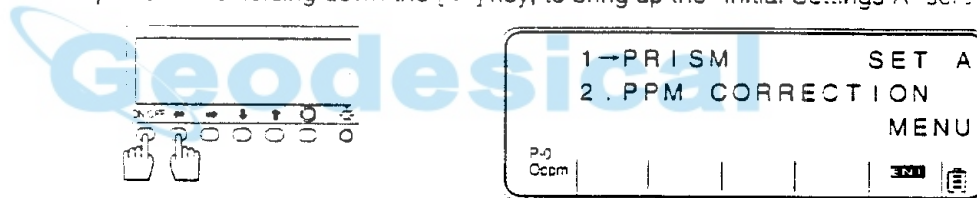

- 2 Pressing the number "1" keypad changes the screen to the "1. Prism" screen, while pressing the number "2" keypad changes to the "2. Atmospheric compensation" screen. (In our example, we will select "1. Prism" here.)

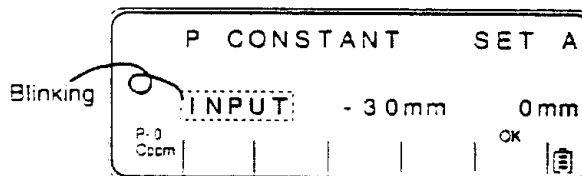
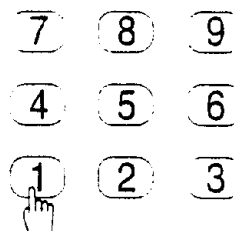

- 3 Use the [←] or [→] key to move the cursor to the target item. (In our example, this will be "0 mm".)

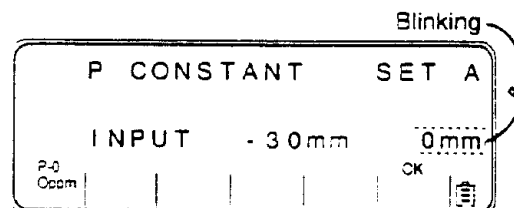
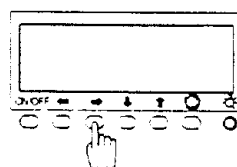

- 4 Press the [OK] key to enter "0 mm" for the prism constant. The screen then returns to the "Initial Settings A" screen.

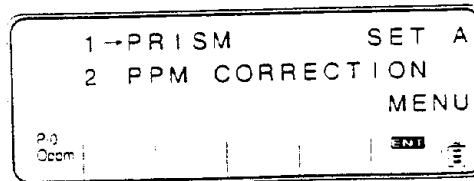
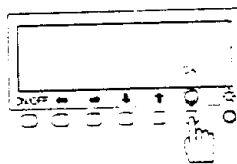

- 5 Use the [ESC] key to exit the "Initial Settings A" screen. The screen changes to the "Vertical Circle 0 Point Setting" screen.

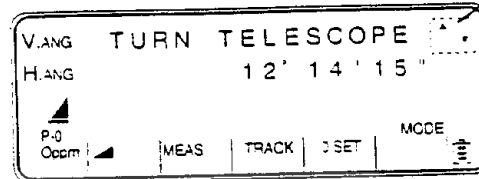
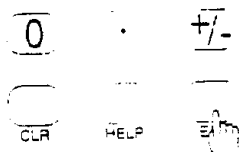

- At step 2, the [↓] or [↑] key could also be used to move the cursor to the desired item, instead of using the numeric keypad. Pressing the [ENT] key would then change the screen to the "Prism Constant" screen. (If the cursor is already positioned at the desired item, simply press the [ENT] key.)
- At step 3, to set the prism constant to -30 mm, move the cursor to "-30 mm", and to set to 0 mm, move the cursor to "0 mm". To input a numeric value for the prism constant, move the cursor to "Input".
- If "Input" is selected, the value "-30 mm" will remain valid until a numeric value is input for the prism constant using the "Compensation Function" in the [B MODE].
- At step 5, the [ON/OFF] key can be used to enter the prism constant, instead of using the [ESC] key.
- If the [ESC] key is pressed during the setting procedure, the screen returns to the "Initial Settings A" screen without changing the settings.
- The same procedure is used for setting all of the initial values.
- (For more detailed information on initial settings, please refer to page 54.)

## Contents of initial settings

For Initial Settings A, B, C, and D, the settings listed below can be selected for the various functions.

**"Initial Settings A"** "Initial Settings A" is used to select the prism constant and the atmospheric compensation.

<b>1. PRISM</b>	→	CONSTANT
		Input      -30 mm      0 mm

Select here whether the input method is to be used with the prism constant, or whether the prism constant is to be fixed at -30 or 0.

<b>2. PPM CORRECTION</b>	→	PPM CORRECTION
		AUTO PPM:    OFF            ON

Select whether the automatic sensor measurement of the atmospheric compensation is to be on or off.

↓	PPM CORRECTION
	PPM CORR:    INPUT      0 PPM

Select whether a ppm compensation value is to be input, or the value is to be fixed at 0 ppm.

↓	PPM CORRECTION
	INPUT:      TEMP.PRES    PPM

Select whether the temperature and air pressure are to be input, or the calculated compensation values will be input.

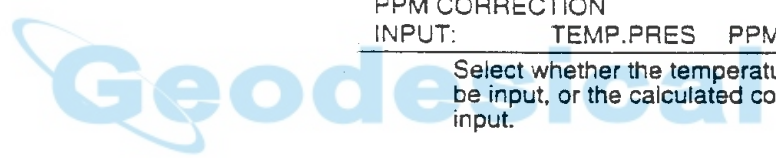



**"Initial Settings B"** "Initial Settings B" is used to select such elements as the distance, angle, beep, cutoff timer, operation and automatic compensation.

## 1. DISTANCE MEASUREMENT

### 1. MINIMUM UNIT

MIN UNIT	DIST
MEAS :	1mm/.005ft      0.1mm/.0005ft

Select the minimum display unit used during normal measurements.

MIN UNIT	DIST
MEAS :	10mm/.005ft      1mm/.0005ft

Select the minimum display unit used during fast(tracking) measurements.

### 2. SHOT

SHOT				
No. :	1	3	5	INPUT

Select the number of shots (the number of times that measurement is to be carried out). Selecting "INPUT" enables to set the number of SHOT any times from 0-99.

### 3. ATM.COMP

ATM.COMP		
COMP :	Yes	No

Select whether the level difference from the zenith distance (atmospheric refraction and divergence of earth curvature) is to be corrected.

ATM.COMP		
CO.E K :	0.14	0.2

Select the coefficient to be used for the level difference from the zenith distance (atmospheric refraction and divergence of earth curvature).

\*In selection of minimum distance unit, either the unit of meter or feet is to be displayed in accordance with the selection of the unit of distance in Initial Settings D.

## 2. ANGLE MEASUREMENT

### 1. MINIMUM ANGLE UNIT

MIN.UNIT		
H/V :	5"/10cc	1"/2cc

Select the minimum display unit for angles measured with the PTS-V2/V3

MIN.UNIT		
H/V :	10"/20cc	5"/10cc

Select the minimum display for angles measured with the PTS-V5

### 2. V ANGLE MODE SETTING

V ANG SET			
0 POINT:	↑0	←0	←↑0

Select the 0 point for the V angle.

V ANG SET		
V DISPLAY:	YES	NO

Select whether or not the vertical angle is normally displayed.

### 3. H ANGLE RETENTION

H ANG HOLD		
	YES	NO

Select whether the horizontal angle is to be retained when the power is turned off.

\*In selection of the minimum angle unit, either angle in degree or gon is to be displayed in accordance with the selection of the unit of angle in Initial Settings D.

## 3. BEEP

1. BEEP VOLUME

VOLUME  
HIGH

LOW

Select whether all of the beep sounds are to be loud or soft.

2. DISTANCE  
MEASUREMENTDIST MEAS  
ON

OFF

Select whether the beep is to sound during distance measurements.

3. 90°

90  
NO

YES

Select whether or not the beep sound is to be produced for every horizontal angle of 90° degrees.

## 4. TIME SETTING

1. POWER

POWER  
10 MIN.

20

30

NIL

This is used to specify how many minutes the power will stay on after the last operation; in other words, how long it will be kept on if there is no operation.

2. EDM

EDM  
3 MIN.

5

10

NIL

This is used to specify how many minutes distance measurement will continue before it stops automatically after the last operation.

3. ILLUMINATION

ILLUM  
3 MIN.

5

10

NIL

This is used to specify how many minutes the display and reticle illumination will continue to stay on before it goes off automatically after the last operation.

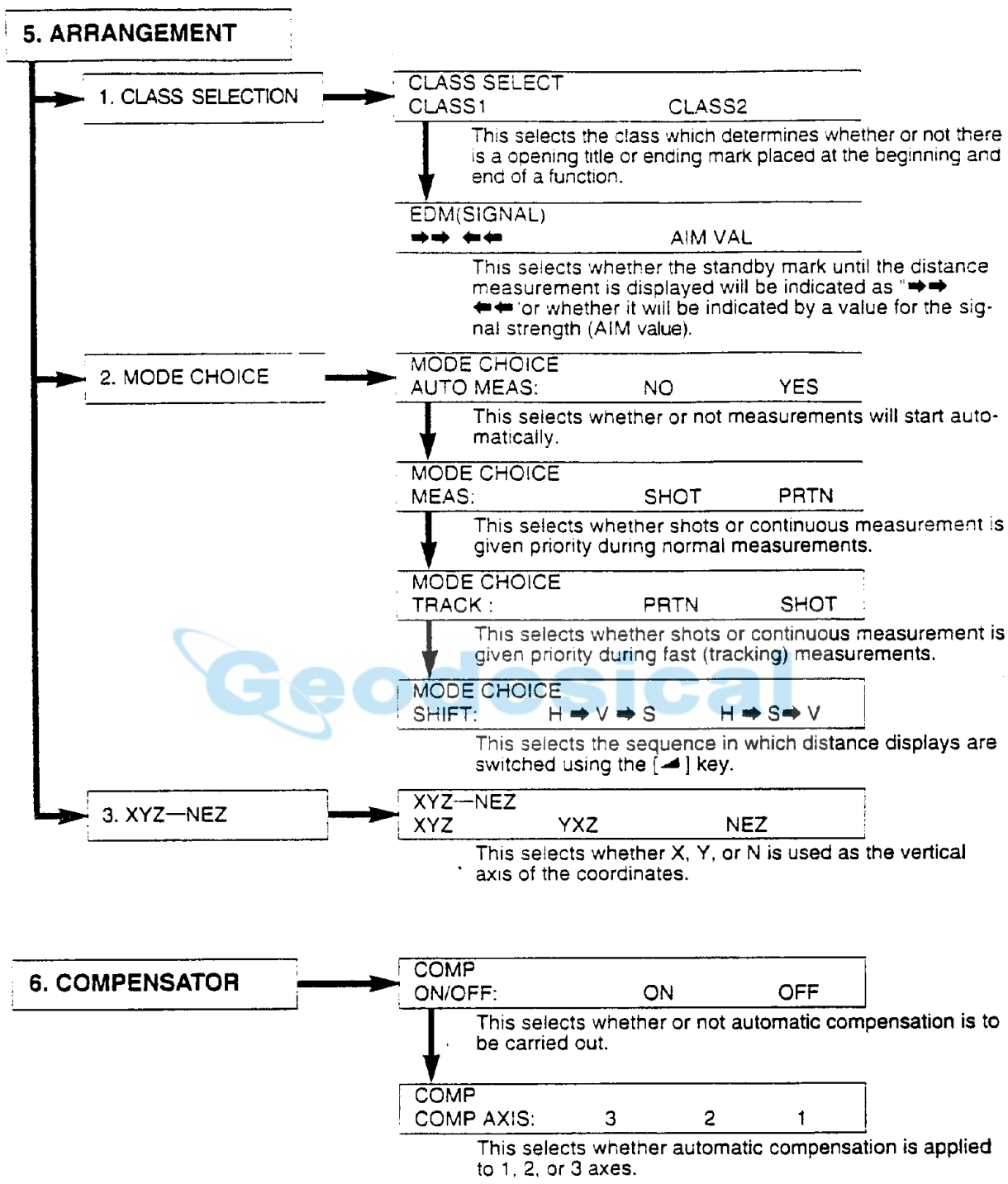

\* If "Off" is selected for "COMP ON/OFF" under "6. COMPENSATOR", the last screen under the Compensator parameter, "COMP AXIS", is not displayed.

"Initial Settings C"

"Initial Settings C" is used to work with the Quick Set, Tool Kit, and Group functions

1. QUICK SET

QUICK SET  
CHECK SET

Select whether the settings of the various functions in Quick Set are to be verified, or whether settings are to be specified.

CHECK

QUICK SET

Switch 1: 1 1 1 1 1 1 1 1

?

Switch 5: 1 1 1 1 1 1 1 1

Check the settings that have been entered for the various functions.

SET

QUICK SET

Switch 1: 1 1 1 1 1 1 1 1

?

Switch 5: 1 1 1 1 1 1 1 1

Change or enter new settings for the various functions.



2. TOOL KIT

TOOL KIT  
CHECK SET

Select whether the settings of the various functions in the Tool kit are to be verified, or whether settings are to be changed.

CHECK

TOOL KIT

REG No. 1

?

REG No. 6

Check to see which software programs have been registered.

SET

TOOL KIT

REG No. 1

?

REG No. 6

Make changes to the registrations, or enter new registrations.

### 3. GROUP

### GROUP CHECK SET

Select whether the group type is to be verified, or settings are to be changed.

#### CHECK

GROUP TYPE:	1	2	3	4	5
-------------	---	---	---	---	---

Verify which numbers have been registered.

#### SET

GROUP TYPE:	1	2	3	4	5
-------------	---	---	---	---	---

Select the number to be registered.

For information on Quick Set, see page 60.  
 For information on Tool Kit, see page 38.  
 For information on Group Software, see page 36.

### "Initial Settings D"

"Initial Settings D" is used to select the unit in which the temperature, air pressure, distance and angle.

### 1. TEMPERATURE/ AIR PRESSURE/ DISTANCE/ANGLE UNIT

TEMP UNIT	C	F
-----------	---	---

Select the unit used to display the temperature.

PRES UNIT	hPa	mmHg	mb	IncHg
-----------	-----	------	----	-------

Select the unit used to display the air pressure.

DIST UNIT	METER	FEET
-----------	-------	------

Select the unit used to display the distance.

ANG UNIT	360°	Dec	Mil	Gon
----------	------	-----	-----	-----

Select the unit used to display the angle.

### "Initial Settings E"

"Initial Settings E" is used to select the communication parameters.

BAUD RATE	1200	24	48	9600
-----------	------	----	----	------

DATE BIT	8BITS	7BITS
----------	-------	-------

PARITY BIT	NONE	ODD	EVEN
------------	------	-----	------

STOP BIT	1BITS	2BITS
----------	-------	-------

X ON / X OFF	ON	OFF
--------------	----	-----

### Using the Quick Set function for setting values

On the "Initial Settings" screen, instead of selecting settings one by one from individual menus, the Quick Set function can be used to process pages divided into 5 sections as a single page.

#### Example: Changing the prism constant "Input" to "-30 mm"

- 1 Turning on the power while holding down the [↓] key brings up the "Initial Settings C" menu.
- 2 If the number "1" is used to select "1. QUICK SET", the screen changes to the "CHECK/SET" screen.

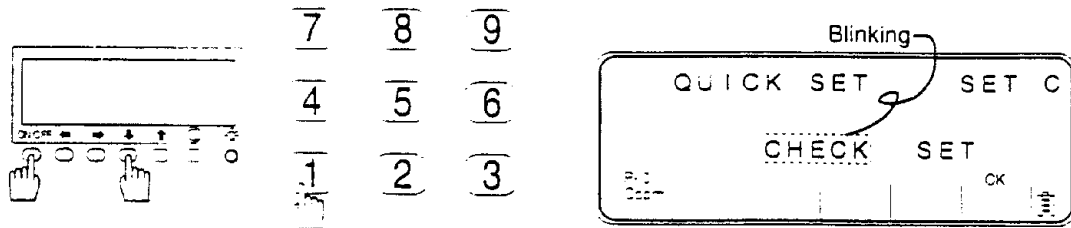

- 3 Using the [→] key, move the (flashing) cursor to the "Setting" item.

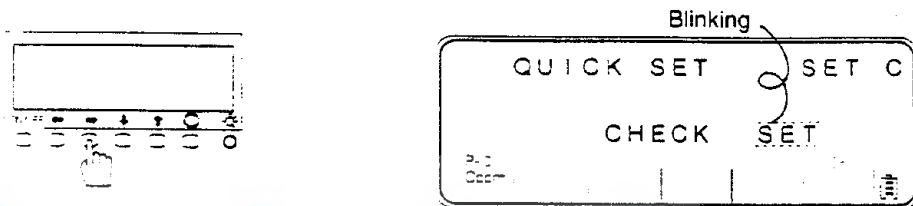

- 4 Press [OK] twice to bring up the setting screen and display "Switch 1". In the diagram used to illustrate this example, the numeric value of the prism constant selection (the value farthest to the left of the 8 values) is set to "1", so "INPUT" is set for the prism constant.

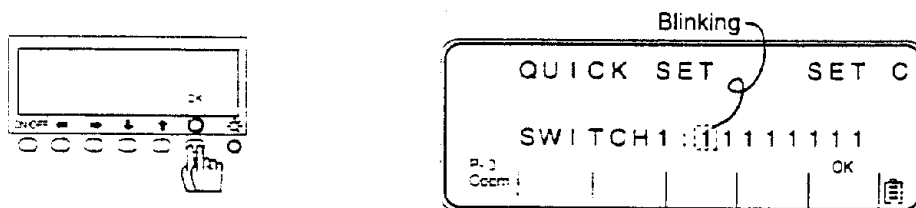

- 5 Since the cursor is positioned at the numeric value of the prism constant selection, press the number "2" keypad, and change the numeric value of "1" to "2", which is a numeric value of -30 mm. (If the cursor is not already positioned on the target number, use the [→] or [←] key to move it to the target number.

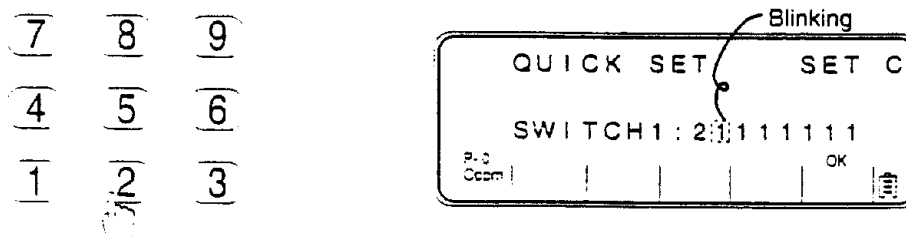

6 Press the [OK] key to display the next screen, entitled "Switch 2".

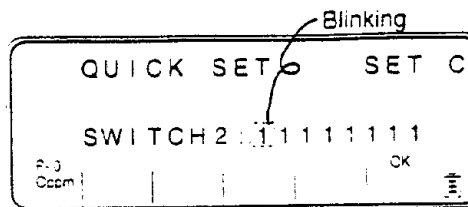
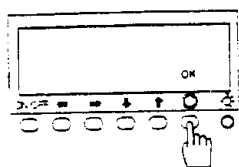

7 Pressing the [ESC] key returns the screen to the "Initial Settings C" menu screen. (To continue entering changes on "Switch 2", repeat the procedure from step 5.)

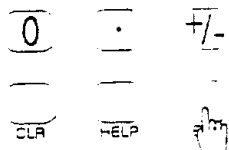

8 If further confirmation and changes are necessary for "2. TOOL KIT" or "3. GROUP", continue following the same procedure. If no more changes need to be made, press the [ESC] key once more to return to the "Vertical Circle 0 Point Setting" screen.

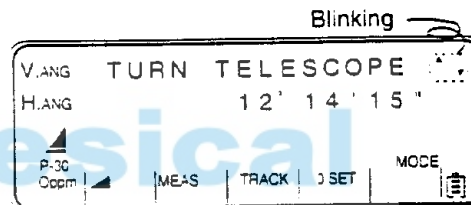

- \* At step 2, the [↓] or [↑] key could also be used to move the cursor to "1. QUICK SET", instead of using the keypad. Pressing the [ENT] key would then change the screen to the "1. QUICK SET" screen. (If the cursor is already positioned at the desired item, simply press the [ENT] key.)
- \* At steps 7 and 8, entering the prism constant can be made by turning the power off using ON/OFF key, instead of using the [ESC] key. The specified prism constant will be entered in the same way as if the [ESC] key had been used.
- \* If the [ESC] key is pressed during the setting procedure, the screen returns to the menu under "Initial Settings C" without changing the settings.
- \* The same procedure is used for all settings included under "QUICK SET".
- \* (For a table of items that can be specified using the "QUICK SET" function, please refer to page 62.)

**Table of Items Applicable to the Quick Set Functions**

The eight number values displayed on the Quick Set screen are lined up from left to right in the order of A, B, C, D, E, F, G, and H.

If there is an X in a column for an item, that number can not be selected.

**Switch 1**

Item No. and Setting Item	Selection Item			
	set to 1	set to 2	set to 3	set to 4
A (left end) Prism constant selection	Input desired constant	-30mm	0mm	—
B Auto ppm selection	OFF	ON	—	—
C ppm correction selection	Input compensated value	Fixed at 0	—	—
D Input of atmospheric correction value	Input temperature and air pressure	Input ppm value	—	—
E Smallest unit displayed (normal measurement)	1mm/0.005ft.	0.1mm/0.0005ft.	—	—
F Smallest unit displayed (fast measurement)	10mm/0.05ft.	1mm/0.005ft.	—	—
G Selection of number of shots	1 time	3 times	5 times	Input no. of times
H (right end) Atmospheric refraction and earth curvature	Compensation ON	Compensation OFF	—	—

\* If the "Auto ppm" function is set to "ON" (the number value second from the left is "2"), no settings can be entered for "C. ppm compensation selection" or "D. Input of atmospheric compensation value".

**Switch 2**

Item No. and Setting Item	Selection Item		
	set to 1	set to 2	set to 3
A (left end) Selection of compensation coefficient	0.14	0.2	
B Minimum angle display (PTS-V2/V3)	5"/10cc	1"/2cc	
B Minimum angle display (PTS-V5)	10"/20cc	5"/10cc	
C Selection of 0 point for vertical angle	Zenith 0	Horizontal 0	Compass scale
D Vertical angle display	Displayed	Not displayed	
E Store horizontal angle in memory	YES	NO	
F Volume for all beeps	Loud	Quiet	
G Beep when measuring	On	Off	
H (right end) Beep for each horizontal 90°	On	Off	



## Switch 3

Item No. and Setting Item	Selection Item			
	set to 1	set to 2	set to 3	set to 4
A (left end) Power supply off timer	10 min.	20 min.	30 min.	No cutoff
B Distance measurement off timer	3 min.	5 min.	10 min.	No cutoff
C Illumination off timer	3 min.	5 min.	10 min.	No cutoff
D Selection of operation class	Class 1	Class 2	—	—
E Type of measurement signal	Symbol	Num. value for signal strength	—	—
F Selection of auto measurement	OFF	ON	—	—
G Priority of measurements in MEAS	Shots	Repeat	—	—
H (right end) Priority of measurement in TRACK	Repeat	Shots	—	—

## Switch 4

Item No. and Setting Item	Selection Item			
	set to 1	set to 2	set to 3	set to 4
A (left end) Sequence of switching distance displays	H→V→S	H→S→V	—	—
B Selection of coordinate axes	XYZ	YXZ	NEZ	—
C Selection of auto vertical compensation	Yes	No	—	—
D Selection of axis compensation	3-axis compensation	2-axis compensation	1-axis compensation	—
E Selection of temperature unit	°C	°F	—	—
F (right end) Selection of air pressure unit	hPa	mmHg	mb	inHg
G Selection of distance unit	m	inch+ft.	ft	—
H Selection of angle unit	Degree	Decimal	Min	Gon

## Switch 5

Item No. and Setting Item	Selection Item			
	set to 1	set to 2	set to 3	set to 4
A (left end) Baud rate	1200	2400	4800	9600
B Selection of data length	8 bits	7 bits	—	—
C Selection of perpendicular parity	NONE	ODD	EVEN	—
D Selection of stop bit(s)	1 bits	2 bits	—	—
E Selection of XON/XOFF	ON	OFF	—	—
F Not in use	Fixed at 0			
G Not in use				
H Not in use				

## Centering and leveling of the instrument

### Setting up the instrument and the tripod

- ① Adjust the tripod legs that a height suitable for observation is obtained when the instrument is set on the tripod.
- ② Hang the plumb bob on the hook of the tripod, and coarse center over the station on the ground. At this time, set the tripod and fix the metal shoes firmly into the ground so that the tripod head is as level as possible, and the plumb bob coincides with the station on the ground.
- ③ If the tripod head is mis-leveled by the action of fixing the metal shoes into the ground, correct the level by extending or retracting each leg of the tripod.

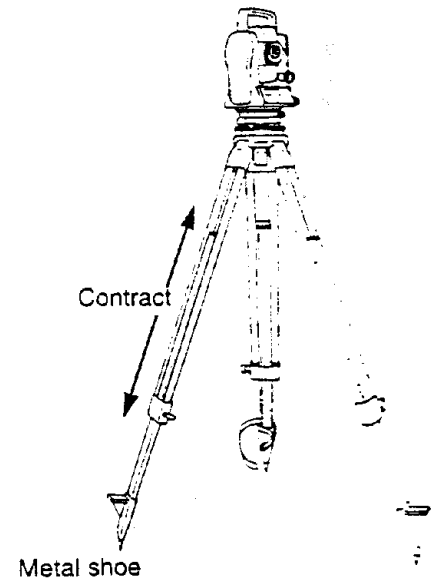
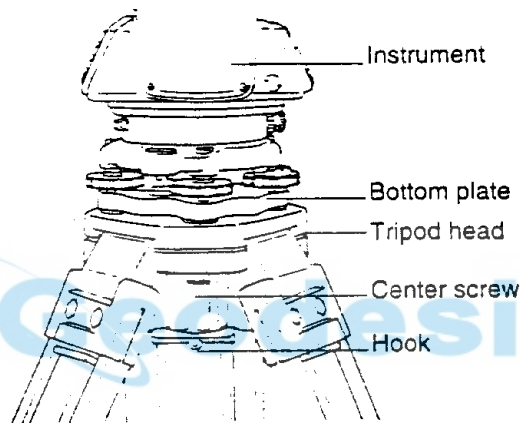

### Centering and leveling with the optical plummet

- ① Look through the optical plummet eyepiece, and rotate the eyepiece knob until the center mark can be seen clearly.
- ② Rotate the focusing knob of the optical plummet and adjust the focus to the station on the ground.
- ③ Loosen the center screw of the tripod. Look through the optical plummet, and shift the instrument base on the tripod head, taking care to avoid rotating the instrument, until the center mark coincides with the station.
- ④ Adjust the tripod legs to position the bubble of the circular vial to the center. (Be sure not to put your foot on the metal shoe, which may disturb the position of the metal shoes.)

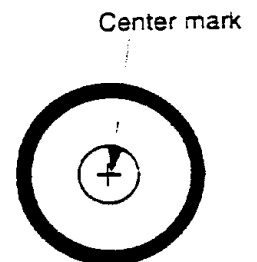

## Leveling with plate vial

- ① Place a plate vial in parallel with a line joining any two of leveling screws. Adjust the two leveling screws. And position the bubble in the center of the vial. To adjust the screws at the same time, turn them in opposite directions.
- ② Adjust the remaining leveling screw so that the bubble in the other plate vial is positioned in the center.
- ③ Repeat ① and ② by rotating the plate vial through  $90^\circ$  so that the bubble is positioned in the center when the plate vial is moved in any direction.

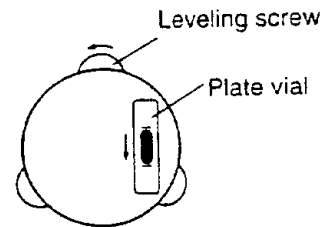
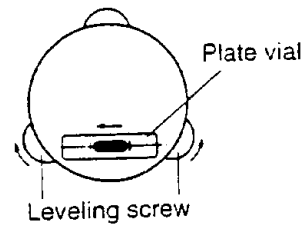

- See arrows in Fig. above for the relation between the direction of leveling screw rotation and the bubble shifting direction.
- If the bubble does not remain centered in ③, "Adjustment of plate vial" is necessary. Refer to page 80.

## Eyepiece adjustment and sighting

### Eyepiece adjustment

- 1 Remove the telescope lens cap.
- 2 Point the telescope at a bright object, and rotate the eyepiece ring full counterclockwise.
- 3 Look through the eyepiece, and rotate the eyepiece ring clockwise until the reticle appears as its maximum sharpness.

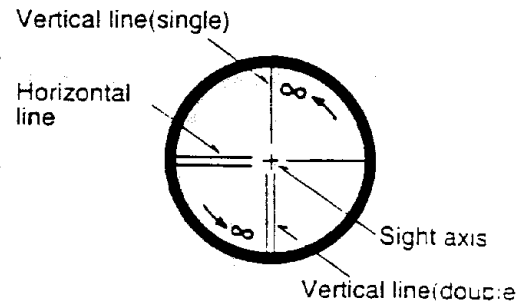

- When looking into the eyepiece, avoid an intense look to prevent parallax and eye fatigue.
- When it is hard to see the reticle due to poor brightness, press (☼) to illuminate it. For adjusting intensity of brightness, refer to page 19.

### Object sighting

- 1 Point the telescope at the object using the collimator sight.
- 2 Look through the telescope eyepiece and finely adjust the focusing knob until the object is perfectly focused. If focusing is correct, the reticle will not move, in relation to the object, even when you move your eye slightly left and right.
- 3 Accurately align the reticle with the object, using each tangent screw.

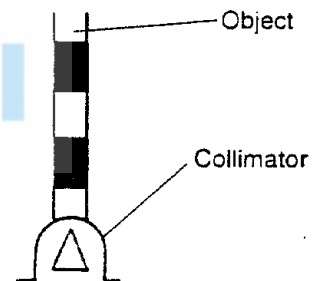

- Turn the focusing knob clockwise to focus on a near object. Turn the knob counterclockwise to focus on a far object.
- In 2, parallax may ruin the relation between the object and reticle, resulting in observation error.
- When aligning to an object using the tangent screw, always align by rotating the screw clockwise. If the screw is turned past the object, turn it back to the original position and then turn the screw clockwise to align the reticle on the object.
- Even when vertical angle measurement is not required, it is recommended that the object be placed close to the center of the reticle.

## Attach and detachment of tribrach

The tribrach is detachable from the instrument if required when replacing the instrument with a target or unit prism for example. (PTS-V2/V3/V5)

### Detachment

First loosen the recessed screw with a screwdriver, then rotate the locking knob until the arrow points upward, and lift the instrument up.

### Attachment

Mount the instrument on the tribrach with the guide marks coinciding, and rotate the locking knob until the arrow points downward.

- When the tribrach does not need to be attached or detached or it is to be transported, tighten the recessed screw with a screwdriver to fix the locking knob.

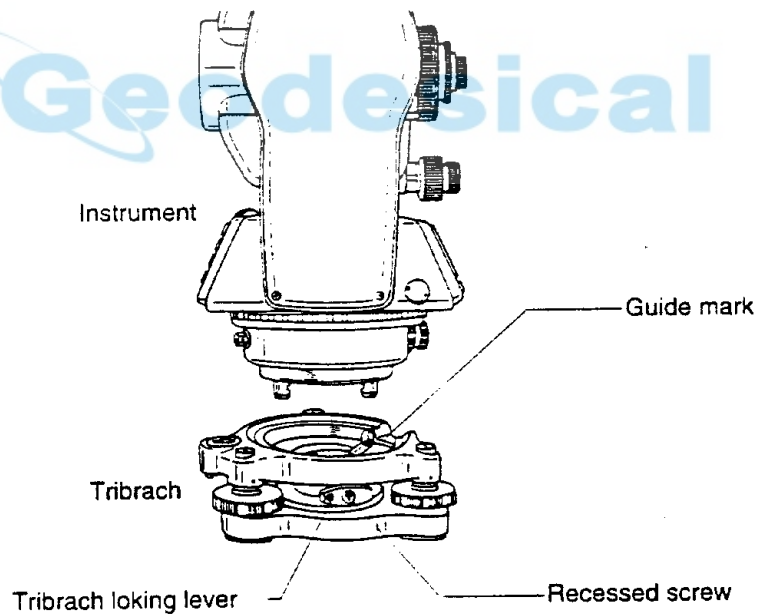

## Plate vial

### Inspection

- 1 Align the plate vial in parallel with a line joining any two of the leveling screws. Then, adjust the two screws to center the bubble in the vial.
- 2 Rotate the instrument  $90^\circ$  and adjust the remaining leveling screw to center the bubble.
- 3 Loosen the upper clamp screw and rotate the instrument  $180^\circ$  around the vertical axis.
- 4 No adjustment is needed if the bubble stays in the center.

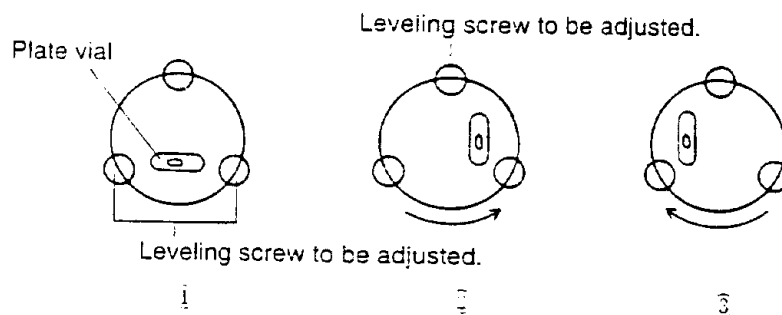

### Adjustment

- 1 If the bubble of the plate vial moves from the center, bring it half way back to the center by adjusting the leveling screw(s) which is parallel to the plate vial.
- 2 Correct the remaining half by adjusting the bubble adjusting nuts with the adjusting pin.
- 3 Confirm that the bubble does not move from the center when the instrument is rotated by  $180^\circ$ .
- 4 When the bubble moves, repeat from 1 once again.

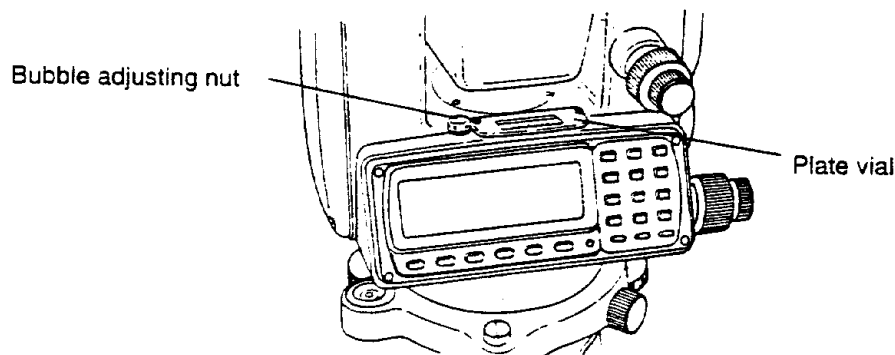

## Circular vial

### Inspection

No adjustment is necessary if the bubble of the circular vial is in the center after inspection and adjustment of plate vials.

### Adjustment

If the bubble of the circular vial is not in the center, bring the bubble to the center by turning the bubble adjusting screws with an adjusting pin.

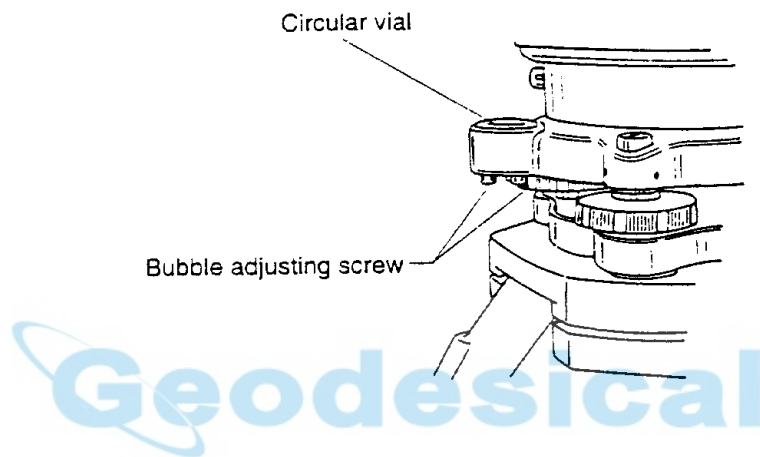

## Optical plummet

### Inspection

- 1 Set the instrument on the tripod, and place a piece of white paper with a cross drawn on it right under the instrument.
- 2 Look through the optical plummet, and move the paper so that the intersecting point of the cross comes to the center of the field of view.
- 3 Adjust the leveling screws so that the center mark of the optical plummet coincides with the intersecting point of the cross.
- 4 Rotate the instrument around the vertical axis. Look through the optical plummet each  $90^\circ$  of rotation, and observe the center mark position against the intersecting point of the cross.
- 5 If the center mark always coincides with the intersecting point, no adjustment is necessary.

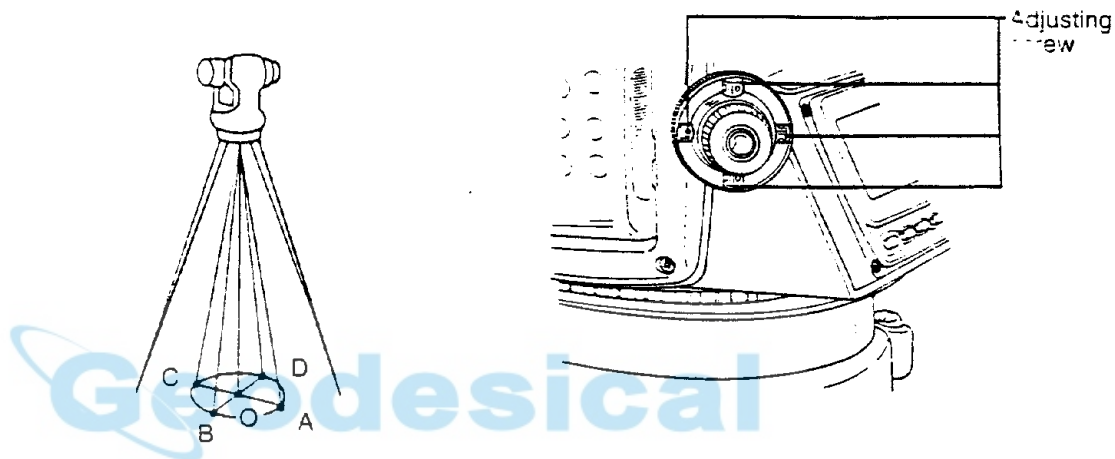

### Adjustment

- 1 If the center mark does not coincide with the intersecting point, rotate the optical plummet focusing knob cover and remove it.
- 2 Mark the point set on the line of sight at each step of  $90^\circ$  on the white paper and call them A, B, C and D.
- 3 Join the opposed points (A,C and B,D) with a straight line, and set the intersecting point O.
- 4 Turn the four optical plummet adjusting screws with an adjusting pin so that the center mark coincides with the intersecting point O.
- 5 Repeat from 1, and check that adjustment is correct.



## Reticle

### Inspection

- ① Set an object A on the line of sight through the telescope.
- ② Move point A to the edge of the field of view by adjusting the telescope tangent screw (point A').
- ③ No adjustment is necessary if point A moves along the vertical line of the reticle.

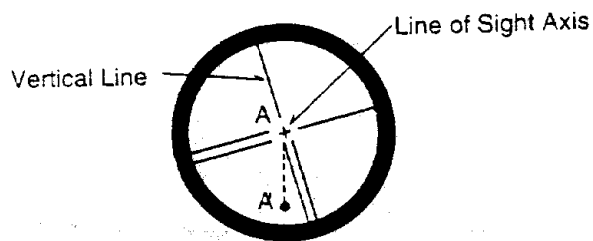

If the point A is widely off the vertical line of the reticle, contact your local dealer for adjustment.

**Geodesical**

### Perpendicularity of line of sight to horizontal axis

- 1 Set an object point A at a distance of 10m- 20m away from the instrument.  
Precisely level the instrument and turn the power on.
- 2 Sight the telescope at point A and read the horizontal angle.  
(Example) Horizontal angle  $10^{\circ} 13' 10''$  - (a) (Normal position)
- 3 Reverse the telescope and loosen the upper clamp screw. Rotate the instrument to sight the point and read the horizontal angle.  
(Example) Horizontal angle  $190^{\circ} 13' 20''$  - (b) (Reversed position)
- 4  $b-a=180^{\circ} 00' 10''$
- 5 No adjustment is necessary when the value in 4 is about  $180^{\circ} \pm 20''$

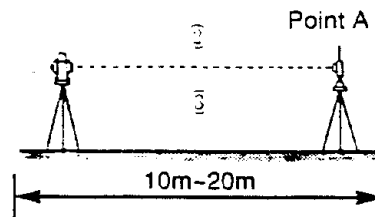

Geodesical

If the value (b-a) is larger than  $180^{\circ} \pm 20''$ , contact your local dealer.

## Vertical O point error

Be sure to follow inspection procedures mentioned below after making adjustments on reticle and perpendicularity of line of sight to horizontal axis.

### Inspection

- 1 Set up the instrument and turn the power on.
- 2 Sight the telescope at any reference target A. Obtain vertical angle ( $\gamma$ ).
- 3 Reverse the telescope and rotate the alidade. Sight again at A and obtain vertical angle  $\ell$ .
- 4 If  $\gamma - \ell = 360^\circ$ , no further adjustment is necessary.

If the deviation  $d(\gamma + \ell - 360)$  is wide, contact your local dealer.

The logo for Geodesical, featuring the word "Geodesical" in a blue, sans-serif font. A blue, stylized orbital ring or path surrounds the letter "G".

## Offset constant

The offset constant rarely changes. It is recommended, however, that inspection be done once or twice a year.

The inspection of the offset constant can be done on a certified base line. It can also be obtained in a simple way as described below.

### Inspection

1. Locate points A, B and C at about 50m intervals on even ground.
2. Set up the instrument at point A, and measure the distances between  $\overline{AB}$  and  $\overline{AC}$ .
3. Set up the instrument at point B, and measure the distance  $\overline{BC}$ .
4. Obtain the offset constant (K):

$$K = \overline{AC} - (\overline{AB} + \overline{BC})$$

■ Contact your local dealer for adjustment of the offset constant when the K is not nearly 0.

# Geodesical

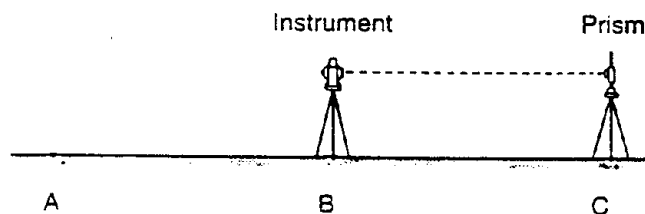
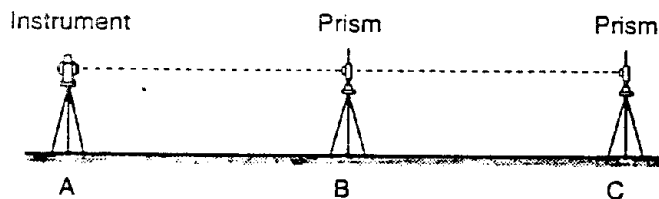

## Beam axis and line of sight

Be sure to check that the beam axis and line of sight are aligned when the adjustments on reticle and perpendicularity of line of sight to horizontal axis are made.

### Inspection

- 1 Set the prism at a distance greater than 50 m.
- 2 Accurately sight the center of the prism through the telescope.
- 3 Turn the power on and press (MEAS) to measure.
- 4 No adjustment is necessary if beam receiving buzzer sounds immediately and measurement value is displayed in a few seconds.

- If instrument functions is not as described in 1, contact your local dealer.
- This inspection should be done under good weather conditions.

### Cautions on Inspection and adjustments

- ◇ Make all inspection and adjustments in numerical order.
- ◇ Be sure not to make inspection and adjustment on "Perpendicularity of line of sight to horizontal axis" prior to those on "Reticle".  
When making adjustments on "Reticle" and "Perpendicularity of line of sight to horizontal axis", be sure to make inspection on "Vertical 0 point error" and "Beam axis and line of sight".
- ◇ When adjustment is completed, be sure that adjusting screws are completely tightened. When finishing turning adjusting screws, be sure that screws are turned in a direction for tightening.
- ◇ Repeat inspection after adjustment, and check if the instrument has been adjusted properly.

### Telescope

Image	Erect
Magnification	32X
Effective aperture	45mm(EDM54mm)
Resolving power	2.5"
Field of view	2.6°(1' 30')
Minimum focus	1.3m

### Distance measurement

Measurement range	
V2 1P	*2.400m(7.900ft) **2.700m(8.900ft)
3P	*3.100m(10.200ft) **3.600m(11.800ft)
V3 1P	*2.200m(7.200ft) **2.500m(8.200ft)
3P	*2.900m(9.500ft) **3.300m(10.800ft)
V5 1P	*1.900m(6.300ft) **2.100m(6.900ft)
3P	*2.500m(8.200ft) **2.800m(9.200ft)

\*Normal conditions :20km visibility with slight haze  
 \*\*God conditions :40km visibility,overcast, no heat haze and moderate wind

(Conversion rate:1m=3.280833ft.)

Accuracy

V2	= (2mm+2ppmxD)mm *=(2mm+10ppmxD)mm
V3	= (3mm+2ppmxD)mm *=(3mm+10ppmxD)mm
V5	= (3mm+3ppmxD)mm *=(3mm+10ppmxD)mm

D: Distance

\*Automatic atmospheric correction

Minimum count

Fine :1mm (.005ft) or 0.1mm (.0005ft)  
 Fast :1mm (.005ft) or 10mm (.05ft)

Measuring time

Fine:2sec.(1mm),3sec.(0.1mm)  
 Fast:0.8sec.(1mm),0.4sc.(10mm)

Measuring system

Automatically repeated or shot  
 (Shot :1.3 AV,5AV or input(0-99))

Maximum slope distance display 4999.999m

Atmospheric correction \*Input of temperature and pressure

(ON/OFF,Auto) \*PPm input (-99-99ppm)

Prism offset 0mm,30mm,numerical input selectable

Atmospheric correction and earth curvature correction ON/OFF selectable/Refraction coefficient 0.14 or 0.2

### Calculation functions

Slope reduction,Distance stakeout,Leveling,RDM.Coordinates measurement,Offset point,Lot staking,Inverse Azimuth/Distance,Traverse,Coordinate stakeout,Horizontal angle repetition,Three dimensional cross sectioning,REM,Resection,Direct stake check,Remote stake check,Offset station point,Area calculation,Scaling.

### Angle measurement

Measuring method	Incremental rotary encoder
Detection method	Diametrically opposite detection (H.V)
Minimum count	
V2/V3	1"(2cc):5"(10cc) selectable
V5	5"(10cc):10"(20cc) selectable
Accuracy (DIN18723)	
V2	2" standard deviation
V3	3" standard deviation
V5	5" standard deviation
Measuring time	0.2"
Diameter of circles	79mm
Measuring mode	

H: R/L, Hold, Retention (in Power OFF)  
 V: Zenith 0/Horizonta. 0.%Compass

### Display section

Method	Dot character and segmen. 3 lines w/back light
--------	---

### Vertical angle compensation

Method	Automatic (ON/OFF selectable)
Type	Liquid reflecting
Compensation range	±3'

### Sensitivity of vials

Plate vial	30"/2mm
Circular vial	8"/2mm

### Optical plummet

Image	Erect
Magnification	3X
Focus range	0.5m- ∞

### Base type

V2/V3/V5	Detachable
V2C/V3C	Shifting

## Ambient temperature

Working range -20°C --+50°C/-4°F --+122°F

## Dimensions/Weight

Instrument

162(W)x343(H)x157(L)mm/6.2kgs.(13.7lbs)

Carrying case

260(W)x250(H)x440(L)mm/2.8kgs.(6.2lbs)

## Battery pack MB02

Power source NiCd(rechargeable)

Output voltage DC6V

Operation time 2.5hrs (for angle and distance) per charge

Weight 155gs.(0.4lbs)

## Charger MC02

Input voltage AC100 ~ 240V 50/60Hz  
DC12 ~ 24V

Charging time 60 minutes

Weight 500grs. (1.1lbs)

The logo for Geodesical features the word "Geodesical" in a light blue, sans-serif font. A stylized blue orbital ring or path curves around the letter "G" and extends slightly to the right.

For longer continuous measurement, use the external battery MB22 (optional accessory).  
When both the on-board battery and external battery are turned on, the power supply from on-board battery is automatically cut off.

### External battery (MB22)

Power supply .....NiCd battery (rechargeable)  
Output voltage .....DC8.4V  
Working time per charging ...10hrs. (continuous) (Distance & Angle Measurement)  
Length of power supply cord ...2m

### External battery charger (MC22)

Input voltage .....AC120V or 220V  
Input frequency .....50/60Hz  
Charging time .....14 ~16hrs.  
Working temperature .....0 C ~+45°C (+32 F ~+113°F)

### Usage

- 1 Fit the external battery on the tripod and attach its connector and the external battery connector of the instrument using the power supply cord.
- 2 Turn on the power supply switch of the external battery.

■ The auto power OFF function is not available when the external battery is in use.

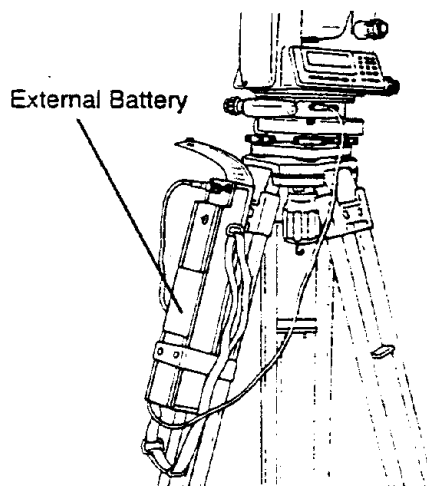



## Charging

- ① Attach the connector of the external battery charger MC22 to that of the external battery.
- ② Insert the plug of the battery charger into a wall socket (AC120V, 220V, 50/60Hz).
- ③ Turn on the power supply switch of the battery and check that the indicator light of the battery charger lights.
- ④ After 14 ~ 16 hours, turn off the power supply switch and remove the connector and plug.

■ Charging time should be shorter than 24 hours.

External battery  
charger MC22

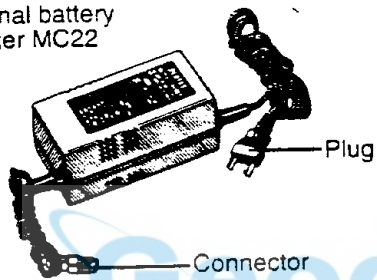

Connector

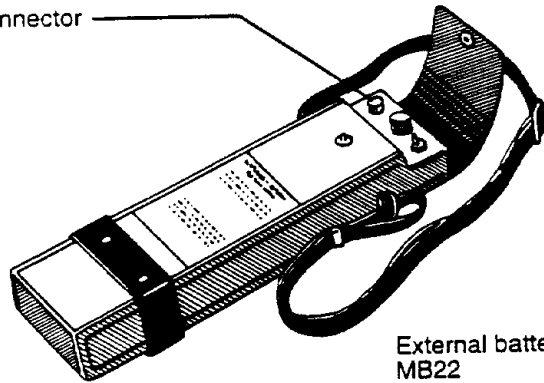

External battery  
MB22

## Tri Axis Compensation (Inclination compensation)

The PTS-V series are capable of compensating the error caused by the inclination of the vertical axis in X and Y directions as well as the error with the line of sight due to the instrument inclination.

ON/OFF selection of the compensation is made in accordance with the necessity of it depending on the type of measurement. Furthermore, any of single, dual or tri axis compensation can be selected when the compensation is ON.

The single axis compensation makes the correction which is calculated based on the amount of mis-level in the X axis (first axis). The X axis is the one which is in line with the sighting direction of the telescope. The mis-level is measured by the compensator and the correction is applied to the vertical angle reading.

The dual axis compensation makes the correction which is calculated based on the amount of mis-level in the Y axis (second axis) in addition to the correction in X axis. The Y axis is the one which is at 90° to the sighting direction of the telescope. The mis-level is measured by the compensator and the correction is applied to the vertical angle reading.

The error caused by the inclination of the vertical axis can not be corrected even by performing a pair of angle measurement with the telescope in both normal and reversed positions. The PTS-V series equipped with a dual axis compensator can provide precise vertical angle measurement. The slight change of the horizontal angle is also found when moving the telescope upward or downward.

In the tri axis compensation, another correction is made in addition to the dual axis compensation. This correction is calculated based on the error in the telescope line of sight (third axis). This correction is applied to the horizontal angle reading. When applying the correction to the sight axis, the error with the line of sight is always corrected. It provides the precise measurement result as if the measurement is done with the telescope in both normal and reversed positions although it is made with the telescope in either normal or reverse position.

When setting a vertical line by sighting the upper and lower positions, for instance, the measurement with the telescope in normal and reversed positions are needed to delete the error unless correction of sight axis is made. Correction of sight axis makes it possible to obtain the same precise result even by the measurement with the telescope in either position.

Sight the ground point, and set the horizontal angle to 0. Aim the telescope upward. The horizontal angle reading slightly changes. This changed reading of the horizontal angle is the amount of errors with angle and sight axis, which should be corrected. Set the horizontal angle to 0 00 00 and sight again. Corrected vertical line is obtained.

## Atmospheric refraction and earth curvature

- The effects of atmospheric refraction and earth curvature can be automatically compensated for measurements of horizontal distance and difference in height.
- Compensation for atmospheric refraction and earth curvature is provided according to the following formula.
- When compensation of atmospheric refraction and earth curvature is valid:

Compensated horizontal distance (H)

$$H = S \left( \cos \alpha + \sin \alpha \cdot \frac{K - 2}{2R_e} \cdot S \cdot \cos \alpha \right)$$

Compensated difference in height (V)

$$V = S \left( \sin \alpha + \cos \alpha \cdot \frac{1 - K}{2R_e} \cdot S \cdot \cos \alpha \right)$$

$$\begin{aligned} \text{H.Distance } H' &= S \cdot \cos \alpha \\ \text{Difference in height } V' &= S \cdot \sin \alpha \end{aligned}$$

S: Slope distance

$\alpha$ : Vertical angle from horizontal

K: Atmospheric refraction coefficient (0.14 or 0.2)

$R_e$ : Radius of the earth (6.370kms.)

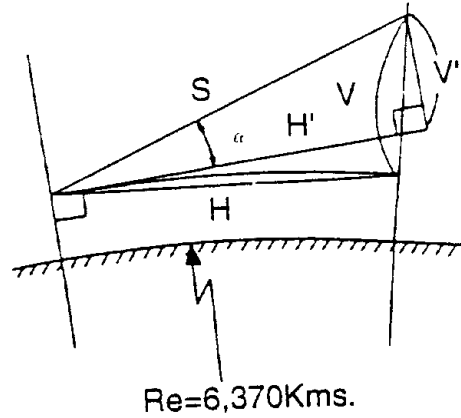

## Atmospheric correction

The velocity of the EDM beam, traveling through the atmosphere varies according to the temperature and atmospheric pressure. Corrections of both factors are necessary in order to measure the distance precisely, because distance measurement is based on the velocity of the beam.

The PTS-V displays the automatically compensated value once the prevailing temperature and atmospheric pressure are entered. The formula of compensation is as follows.

$$K = \left( 279.75207 - \frac{79.55626 \cdot P}{273.14941 + t} \right) \times 10^{-6}$$

K: Compensation coefficient

P: Atmospheric pressure (mmHg)

T: Temperature (C)

The logo for Geodesical, featuring the word "Geodesical" in a light blue, sans-serif font. A stylized blue ring or orbit surrounds the letter "G".

**Deviation of distance when no atmospheric correction is made**

Factory setting of values of atmospheric factors are 15°C in temperature and 760mmHg in atmospheric pressure. When the surrounding conditions differ from the factory settings, corrections of atmospheric factors are needed to avoid the measurement error. Following tables show the error per 100m or 500ft. when no corrections are made.

**1) mmHg (Reference PPM value : 15°C, 760mmHg)**

mmHg \ °C	900	800	760	700	600	500	400
45	2.0	-1.3	-2.6	-4.6	-8.0	-11.3	-14.6
35	3.0	-0.4	-1.8	-3.9	-7.3	-10.8	-14.2
25	4.0	0.5	-0.9	-3.1	-6.6	-10.2	-13.7
15	5.2	1.5	0.0	-2.2	-5.9	-9.6	-13.3
5	6.3	2.5	1.0	-1.3	-5.1	-8.9	-12.7
-5	7.6	3.7	2.1	-0.3	-4.2	-8.2	-12.2
-15	9.0	4.9	3.3	0.8	-3.3	-7.4	-11.5

Unit: Millimeter

**2) InHg (Reference PPM value : 50°F 29.9InHg)**

InHg \ °F	33.0	29.9	28.0	26.0	24.0	22.0	20.0	17.0
140	-.0925	-.0705	-.0570	-.0430	-.0290	-.0145	-.0010	.0200
113	0	.0130	.0210	.0295	.0380	.0465	.0550	.0680
86	-.0065	.0070	.0150	.0240	.0330	.0420	.0510	.0640
59	-.0140	0	.0090	.0180	.0275	.0370	.0460	.0605
32	-.0225	-.0070	.0015	.0115	.0215	.0315	.0410	.0560
5	-.0320	-.0160	-.0060	.0040	.0145	.0250	.0355	.0510
-22	-.0425	-.0255	-.0150	-.0040	.0070	.0180	.0290	.0455

Unit: Feet

## Error messages

Message	Meaning	What to do
C-OVER	Displayed when the instrument is tilted beyond the vertical compensation range ( $\pm 3'$ ) in case the automatic compensation is ON. (This message may be temporarily displayed if the instrument is turned too fast.)	Relevel the instrument. Repair is needed if the message is displayed when it is properly leveled.
*NG!! V-OVER TURN SCOPE	Displayed when the telescope is turned too fast.	Turn the telescope up and down. Remeasure.
*NG!! H-OVER PUSH 0	Displayed when the alidade is turned too fast.	Press 0 SET key. Remeasure.
*NG!! REPEAT-OVER REMEASURE	Displayed when the number of repeat exceeds 9 times in H. angle repetition.	Press OK key Remeasure.
*NG!! SUM-OVER REMEASURE	Displayed when the angle sum exceeds the allowable range in H. angle repetition. (more than $2777^\circ$ )	Press OK key Remeasure.
*NG!! AVG-ERROR REMEASURE	Displayed when the difference of averaged value between the previous and present measurements exceeds $\pm 60''$ in H. angle repetition.	Press OK key Remeasure.

Message	Meaning	What to do
<p style="text-align: center;">*NG!! CAL. RANGE-OVER REMEASURE</p>	<p>Displayed when calculation of input coordinates or result of coordinate measurement exceeds the allowable range.</p>	<p>Press OK key. Remeasure.</p>
<p>ERROR!! EDM ERROR 04</p> <p>ERROR!! EDM ERROR 05</p> <p>ERROR!! EDM ERROR 31</p> <p>ERROR!! EDM ERROR 32</p>	<p>Some problem found in the distance measurement circuit</p>	<p>Turn the power off, and turn it on again. The repair is needed when the message is still on the display.</p>
<p>ERROR!! ETH ERROR 08</p> <p>ERROR!! ETH ERROR 16</p>	<p>Some problem found in the angle measurement circuit</p>	<p>*Improper operation may display the message.</p>
<p>ERROR!! MEMORY ERROR 19</p>	<p>Some other problem in the instrument</p>	



 **Geodesical**

The word "Geodesical" is written in a bold, blue, sans-serif font. A light blue, thin-lined oval shape is positioned behind the letter 'G', partially overlapping it.



 **Geodesical**

 **Geodesical**

## Command No. Table

### Special Functions

Program Name	Command No.
Distance Stake-out	101
Leveling	102
RDM	103
Coordinates	104
Offset Point	105
Lot Staking	106
Inverse Azimuth/Distance	107
Traverse	108
Coordinate Stake-out	109
H. Angle Repeat	110
3D Cross Section	111
REM	112
Resection	113
Direct Stake Check	114
Remote Stake Check	115
Offset Station	116
Area	117
Scaling	118

### Initial Settings

Item	Command No.
------	-------------

#### Settings A

Selection of constant	401
PPM correction	402

#### Settings B

Distance	Selection of minimum reading	501
	Selection of number(s) of shots	502
	Selection of atmospheric compensation	503
Angle	Selection of minimum reading	504
	Selection of V angle mode	505
	Retention of H angle	506
Beep	Beep volume	507
	Beep in measurement on/off	508
	90° Beep on/off	509
Power setting	Auto power OFF	510
	Auto EDM power OFF	511
	Auto Illumination OFF	512
Operation	Title display YES/NO	513
	EDM symbol YES/NO	514
	Preferential mode	515
	XYZ - NEZ	516
	V. angle compensator ON/OFF	517

#### Settings C

Quick set	601
Tool kit	602
Grouping program	603

#### Settings D

Selection of angle unit	701
Selection of distance unit	702
Selection of temperature and air pressure units	703

#### Settings E

Communication parameters	801
--------------------------	-----



**PENTAX**  
ASAHI PRECISION CO., LTD.  
1-1-21, Shirako, Wako-shi,  
Saitama-ken, 351-01, Japan

**Geodesical**

