

TC605/TC805/TC905/L

Electronic total station

English

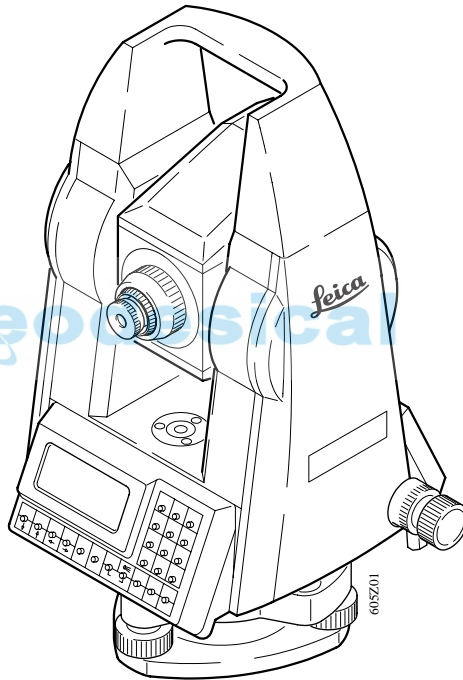

USER MANUAL

Leica

Thank you for purchasing this Leica Total Station.



This manual contains important safety directions (*refer to section "Safety directions"*) as well as instructions for setting up the instrument and operating it. Please read carefully through the User Manual to achieve maximum satisfaction.

TC605/TC805/TC905/L

Electronic total station



Product identification

The instrument model and the serial number of your product are indicated on the label in the battery compartment.

Write the model and serial number of your instrument in the space provided below, and always quote this information when you need to contact your agency or service workshop.

Type: _____ Serial no.: _____

Symbols used in this manual

The symbols used in this User Manual have the following meanings:



DANGER:

Indicates an imminently hazardous situation which, if not avoided, will result in death or serious injury.



WARNING:

Indicates a potentially hazardous situation or an unintended use which, if not avoided, could result in death or serious injury.



CAUTION:

Indicates a potentially hazardous situation or an unintended use which, if not avoided, may result in minor or moderate injury and / or appreciable material, financial and environmental damage.



Important paragraphs which must be adhered to in practice as they enable the product to be used in a technically correct and efficient manner.

Contents

Introduction	8
Applicability	8
Important parts	9
Set-up, getting started	12
Unpacking	12
Charging battery	13
Set-up	14
Tribrach with optical plummet	14
Tribrach without optical plummet	15
Instrument with laser plummet	16
Level instrument with the electronic level	17
Operating concept	18
Settings, first steps	18
Units in this manual	18
Display and keyboard	19
Fixed keys	20
Function keys	20
Control keys	21
Input keys	21
Inputs	22
Numeric / alphanumeric entry mode	22
Entering reflector height	23
General information	23
Menu tree (main menu)	24
Menu tree (configuration)	25
Menu tree (programs)	26
Main menu	26
Measure and record	27
Display symbols	27
Pointing and distance measurement	28
Example: for offset or hidden points	29
Tracking mode	30
Display of recorded measurements	30
Measure and record with coding	31
Coding	32
Input a new code line to the code list	32
Function "Quick-Code"	33
Simple code input during measurements	34
Additional entries to selected code	36
Recording codes	37
Searching for codes using wildcards	38

User Programs	39
Introduction	39
Point search in programs	39
Set Job	40
Set station coordinates and Orientation (Set Station)	41
Orientation of horizontal circle	45
Free Station	47
Setting out (Setout)	52
Tie Distance (Missing line)	54
Area computation (Calc Area)	57
Rapid measurement and recording (Rapid Meas)	60
Reference Line (Ref. Line)	62
Settings	70
Entering point number and reflector height	70
Setting the horizontal circle (Hz)	72
1st variant	72
2nd variant	73
Setting the display mask (DSP)	74
Data management (DATA MANAGER)	75
Input of coordinates and codes (INPUT)	76
Coordinate entry (COORDS)	76
Code input (CODES)	77
Searching for point numbers and multiple recordings (FIND)	78
Searching for several data blocks with the same point number	80
Display of stored data (VIEW)	81
Delete measurements, coordinates and codes (DELETE PNT)	82
Delete the complete range of measurements, coordinates and codes (DELETE ALL)	83
EDM Configuration (EDM CONF)	84
1. EDM mode	84
2. EGL (Guide Light)	84
3. INTENS	85
4. RETTAP	86
Testing the instrument	88
Battery and instrument temperature	88
EDM Signal (INTENSITY)	89
Configuration (CONFIG MENU)	90
Distance corrections	91
Display contrast (CONTRA)	93
Data and recording parameter (REC DATA)	94

Selecting units (UNITS)	97
Setting time and date (TIME/DATE)	99
Automatic switch-off (ON/OFF)	101
TCTOOLS	104
Other data formats	110
Communication TC605/TC805/TC905/L and PC/Datalogger	111
Set a point number	111
Set station coordinates	111
Set orientation	111
Setting-out	112
Checking and adjusting	113
Determine instrument errors (CALIB)	113
Vertical index error	114
Line-of-sight error (Hz-collimation)	117
Tripod	118
Circular level	119
Circular level on the tribrach	119
Optical plummet	120
Laser plummet	122
Care and transport	124
Battery charging	126
Battery chargers GKL22 and GKL23	126
Battery chargers GKL12 and GKL14	127
Safety directions	128
Intended use of instrument	128
Limits of use	129
Responsibilities	130
Hazards of use	131
Laser classification	136
Integrated distancer (EDM)	136
Guide Light EGL1 (optional for TC805/TC905/L series)	138
Laser plummet	140
Electromagnetic acceptability	144
FCC statement (applicable in U.S.)	145
Product labeling	146
Error reports and warnings	147
Technical data	149
Index	155

Introduction

The TC605/TC805/TC905/L is particularly suitable for engineering, building and construction surveys with a focus on setting outs, volume determinations and tacheometry surveys. Fast and easy coding facilities are provided. The accuracy of angle-measuring, and the range of its EDM module, are matched to one another. The measured data can be stored in the internal memory or can be output individually via serial interface to an external recorder.

Applicability

This manual applies to the following types of total stations:

- TC605, TC605L
- TC805, TC805L
- TC905, TC905L

Differences between the three versions TC605/TC805/TC905/L are clearly set out and assigned.

General text applies to all versions.

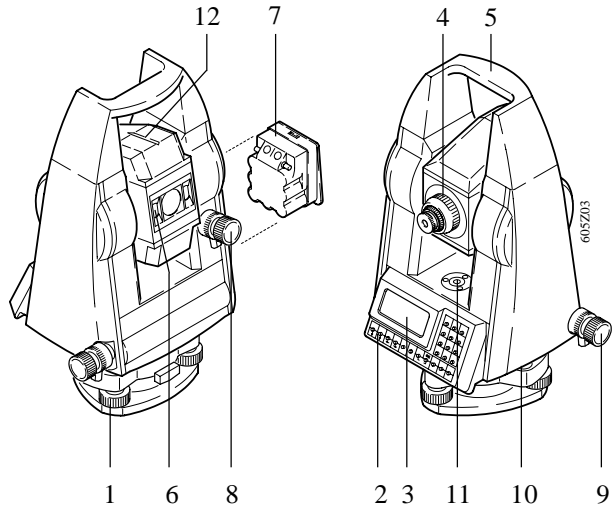

Geodesical

- | | |
|-------------------|-------------------------------|
| 1 Foot screw | 7 Battery |
| 2 Keyboard | 8 Vertical drive |
| 3 Display | 9 Horizontal drive |
| 4 Focusing | 10 Serial Interface
RS-232 |
| 5 Carrying handle | 11 Circular level |
| 6 EDM transmitter | 12 Optical sight |

TC805/L

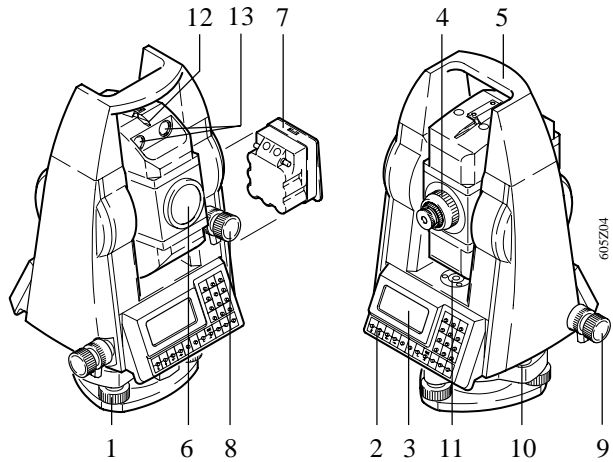

- | | | | |
|---|-----------------|----|----------------------------|
| 1 | Foot screw | 8 | Vertical drive |
| 2 | Keyboard | 9 | Horizontal drive |
| 3 | Display | 10 | Serial Interface
RS-232 |
| 4 | Focusing | 11 | Circular level |
| 5 | Carrying handle | 12 | Optical sight |
| 6 | EDM, Telescope | 13 | EGL1 (optional) |
| 7 | Battery | | |

TC905/L

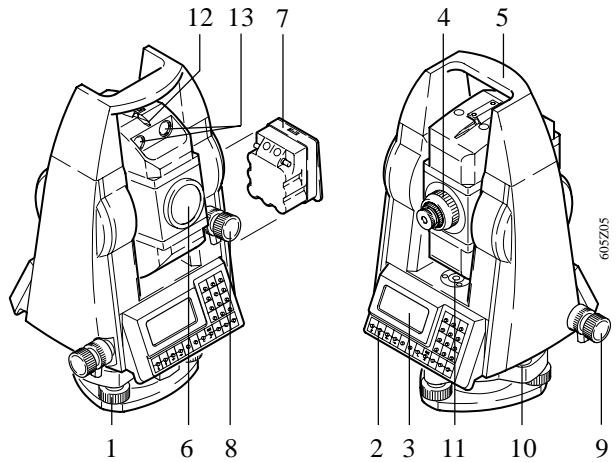

- | | |
|-------------------|----------------------------|
| 1 Foot screw | 8 Vertical drive |
| 2 Keyboard | 9 Horizontal drive |
| 3 Display | 10 Serial Interface RS-232 |
| 4 Focusing | 11 Circular level |
| 5 Carrying handle | 12 Optical sight |
| 6 EDM, Telescope | 13 EGL1 (optional) |
| 7 Battery | |

Set-up, getting started

Unpacking

Remove TC605/TC805/TC905/L from transport case and check for completeness:

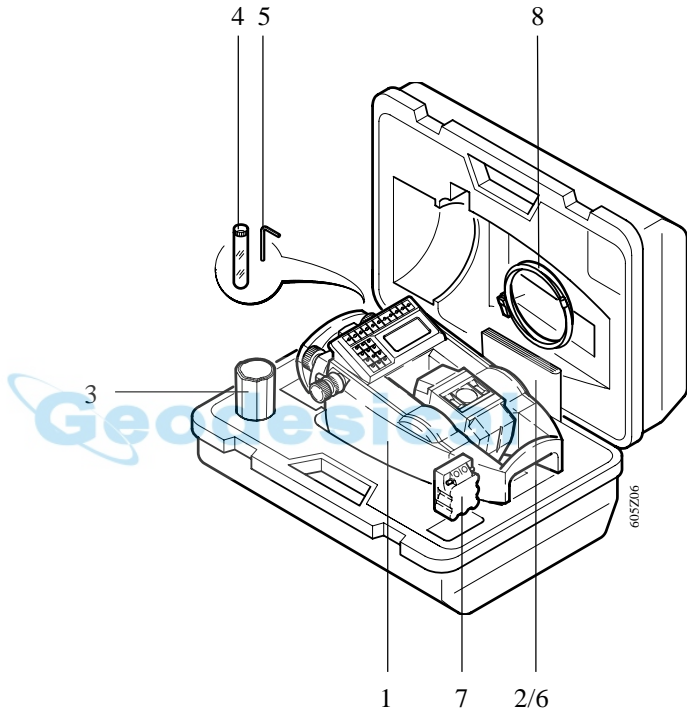

- | | |
|--------------------|----------------------------|
| 1 Instrument | 6 Diskette with TCTOOLS |
| 2 User's Manual | 7 Spare battery (optional) |
| 3 Protective cover | 8 Data cable (RS232) |
| 4 Set of pins | |
| 5 Allen key | |

Charging battery

Charge batteries using GKL12, GKL14, GKL22 or GKL23. For more information about charging batteries refer to chapter "Battery charging".

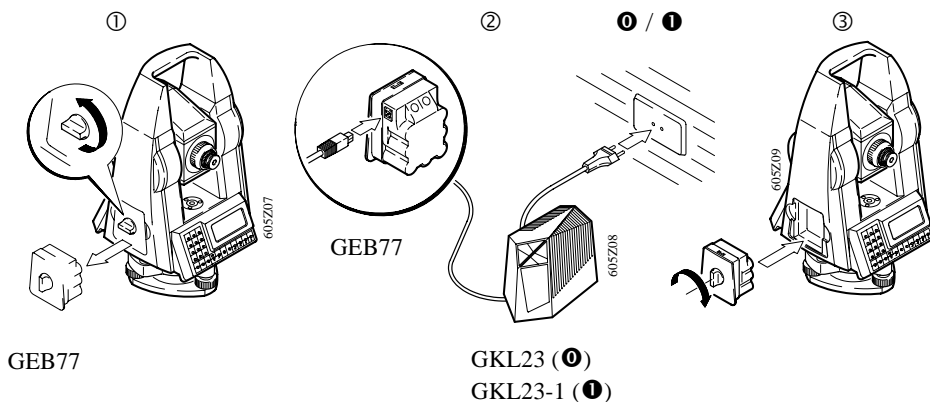

⓪ Version for 230V mains

Ⓛ Version for 115V mains

Geodesical

Charging time:

Internal battery:	GEB77	1.0 hours
External batteries:	GEB70	1.5 hours
	GEB71	5.0 hours

(Refer also to chapter "Technical Data")



WARNING:

The battery chargers are intended for indoor use. Only use a battery charger in a dry place, never outdoors.

Set-up

Tribrach with optical plummet

Set-up TC605/TC805/
TC905 with tribrach
GDF 22 and tripod
GST20

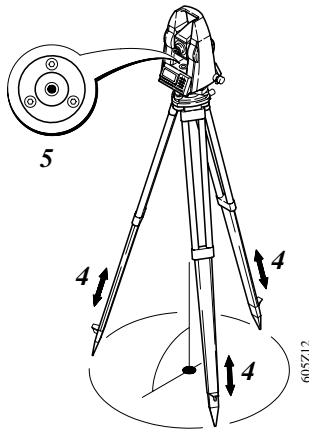
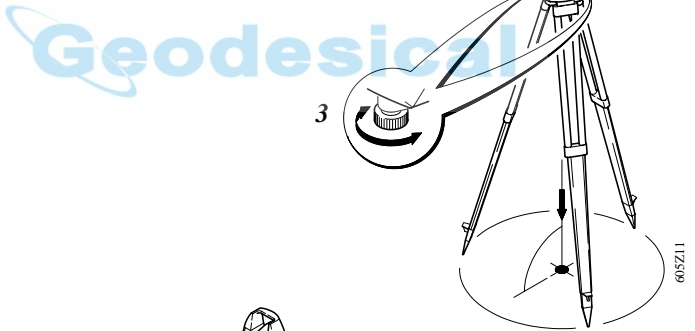
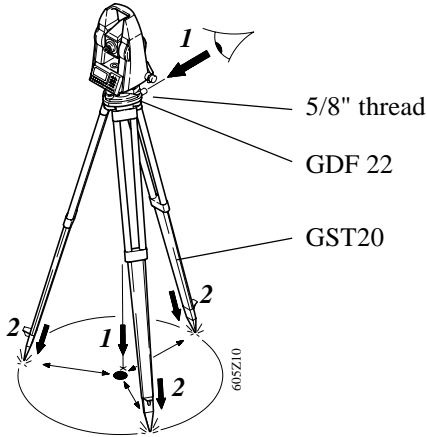

Tribrach without optical plummet

Set-up TC605/TC805/
TC905 with tribrach
GDF 21 and tripod
GST20

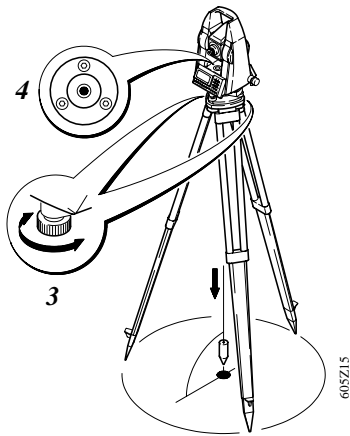
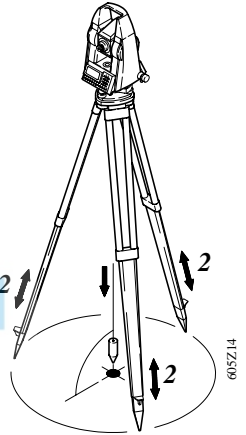
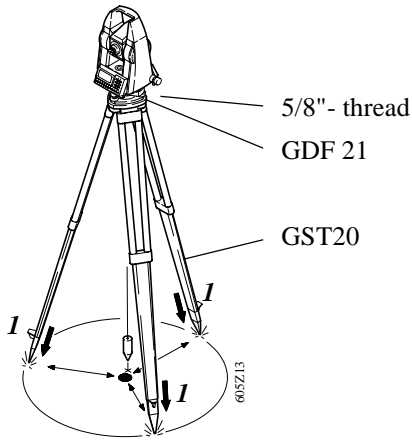

Instrument with laser plummet

The laser plummet is activated in the measuring display. The instrument can be levelled-up using the electronic level.



Press (for about 2 seconds) until the following display appears. The laser plummet is switched on (red spot on ground) and the electronic level is shown.

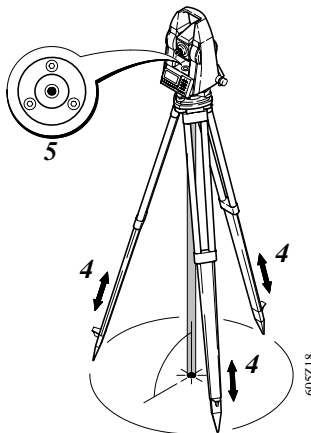
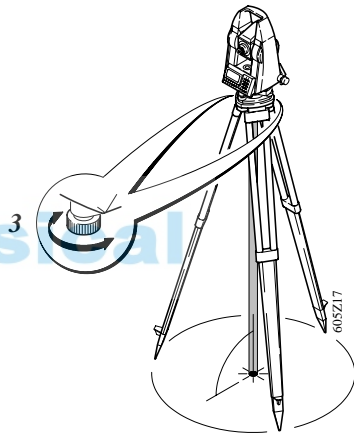
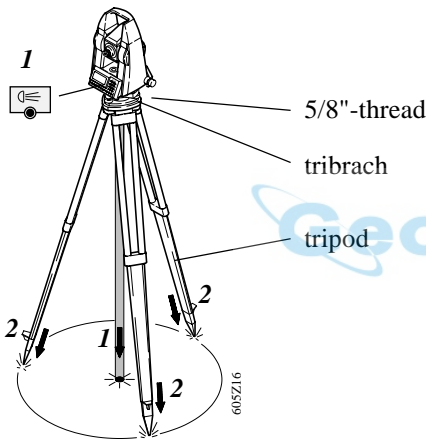
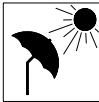

or



Switch off plummet and quit display.

**Level instrument with
the electronic level**

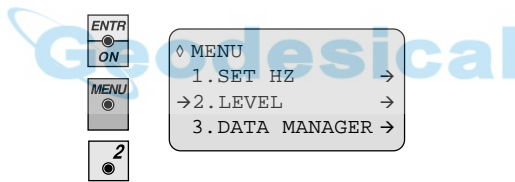
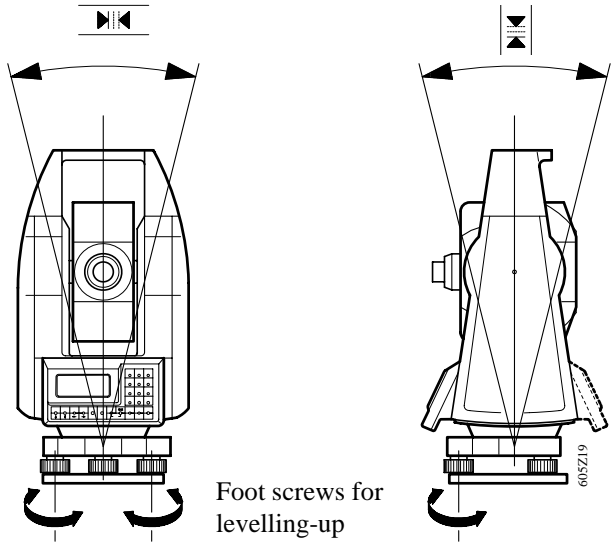

Insufficient levelling-up



Perfect levelling-up



The TC605/TC805/TC905/L unit is correctly levelled-up when the triangles are visible only or markers are displayed **between** the triangles.

Operating concept

Settings, first steps

The following settings are possible:

Units for distance measurement (DIST):

- m = meters
- US ft = feet (in decimals)

Units for angle measurement (ANGLE):

- gon = 400gon
- 360d = 359°.9999 (in decimals)
- 360s = 359° 59' 59" (sexagesimal)

Display number of decimal places (ROUND):

- high = 81°45' 24" (1" Interval)
- med = 81°45' 25" (5" Interval)
- low = 81°45' 20" (10" Interval)

For more informations refer to *section "Selecting units (UNITS)"*.



Units in this manual

Specifications within this manual always applies to the following units:

Units of length:

- in m (meter)
- in addition, within brackets in US ft (feet)

Units of angle:

- in ° ' "
- in addition, within brackets in gon

Units of temperature:

- in °C
- in addition, within brackets in °F

Display and keyboard

The display and the keyboard are divided into specific areas, making the layout clear and the operational procedure easy to learn.

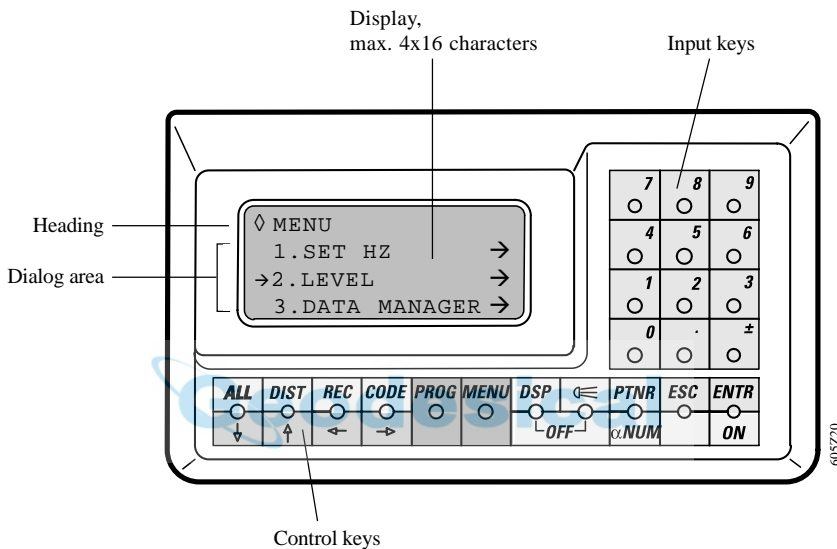

The four colour groupings for the keys are:

- Grey: Fixed keys
- Orange: Programs and functions
- Green: Control keys
- Yellow: Input keys

Fixed keys



Turns the instrument ON.



Distance is measured and current measured values are stored.



Distance is measured and values are displayed, but not stored.



Recording measurements (as displayed).



Access coding.



Changes display masks.



Switches on/off display illumination.
Switches on the laser plummet (if pressed for about 2 seconds).



Entering point numbers.
Switches between numbers and characters during input of point numbers and coding (assignment of  to



).



Turns the instrument OFF.

Function keys



Calls up the on board applications.



Calls up the main menu (short press).
Calls up the configurations menu: long press (about 2 seconds).

Control keys



Selecting of functions and input lines (down);
Changing of data display lines.



Selecting of functions and input lines (up);
Changing of data display lines.



Positioning of cursor left; for input of numbers and
selecting parameters.



Positioning of cursor right; for input of numbers and
selecting parameters.

Input keys



For input of numbers and alphanumeric characters.



Enters the decimal point and alphanumeric characters.



Switches between positive/negative sign; inserts a "*" for wildcard search when using the  key.



Confirms input and values.





Interrupts active function;
Deletes error messages;
Quits inputs without accepting values.

Inputs

Numeric / alphanumeric entry mode

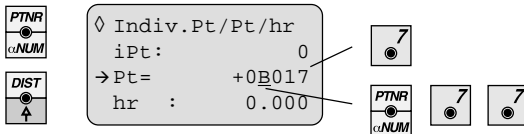
Use the  key to toggle between numeric or alphanumeric entry mode.



 Confirm inputs.

 Rejecting inputs. Deletes characters from right to left. All entered characters must be deleted to exit the entry mode.

Alphanumeric entry mode

To each numerical key ( ... , ) 3 alphanumeric characters are assigned.

The various letters are selected by pressing the numeric keys quicker than 1 second.

For a successive input of identical letter or characters you must wait for one second (until cursor disappears).

The alphanumeric entry mode is identified by the character "α".

Available alphanumeric characters are:
A to Z, Space, /, \$, %, _ , | , . , &.

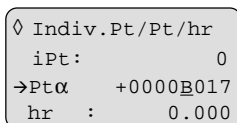

The entry of alphanumeric characters is the same as on mobile phones.

Entering reflector height

Press the -key to enter individual or running pointnumber and the reflector height (**hr**).

General information

Start of a submenu:

- Move cursor (→) to the desired submenu using keys

 /  and call submenu with keys  or .

- direct calling by pressing the corresponding numerical key.

Cursor at top of selection list.

```
√MENU
→1. SET HZ      →
 2. LEVEL      →
 3. DATA MANAGER →
```

Cursor at end of selection list.

```
^MENU
 3. DATA MANAGER →
 4. EDM CONF      →
→5. TEST          →
```

Both above and below cursor are selection fields.

```
◇MENU
→2. LEVEL      →
 3. DATA MANAGER →
 4. EDM CONF      →
```

Cursor for indicating additional functions.

```
^MENU
 3. DATA MANAGER →
 4. EDM CONF      →
→5. TEST          →
```

The point marks a permanent indication.

```
^SET JOB
Job:      0
Ope:      0
•Dat:     12/03/97
```

Menu tree (main menu)

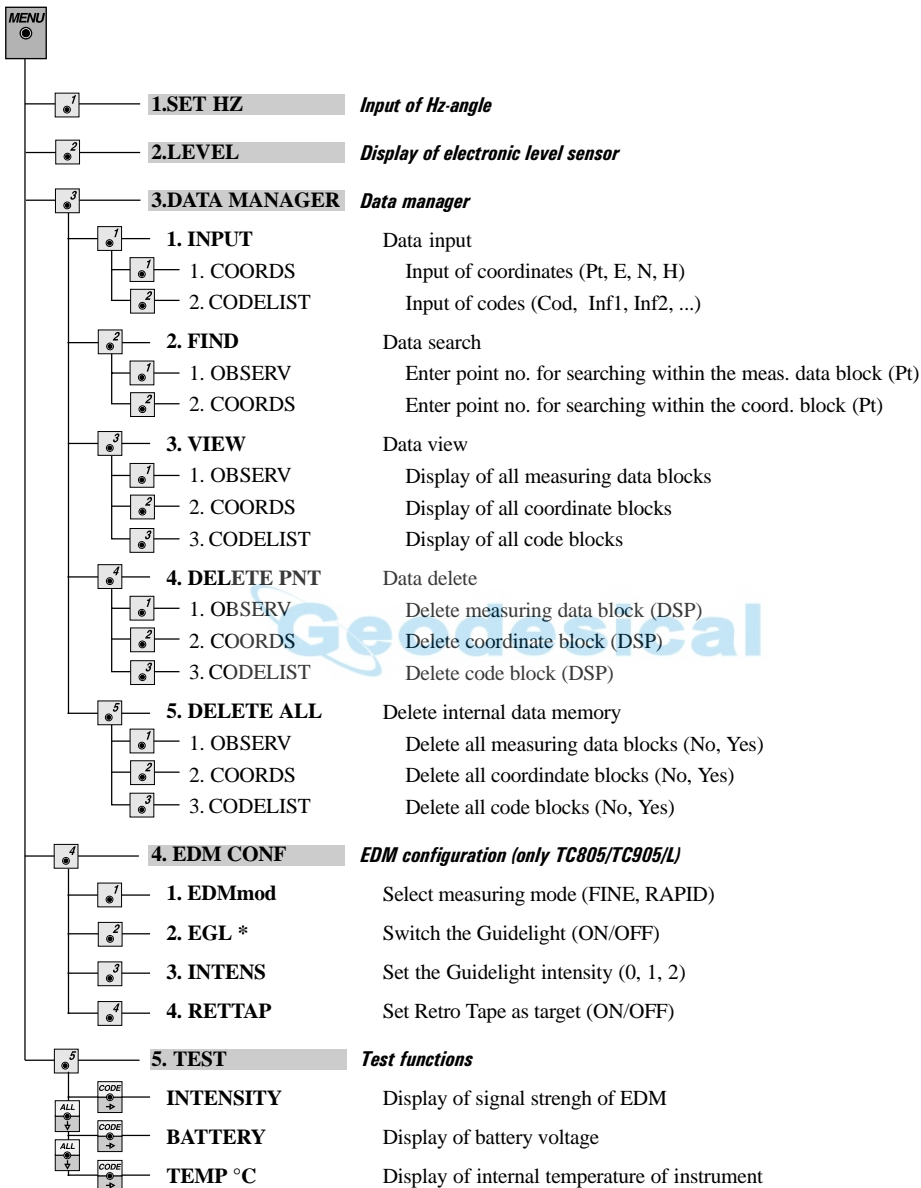

* EGL is an optional accessory for TC805/TC905/L

Menu tree (configuration)



Press (for about 2 seconds) until the configuration menu appears.

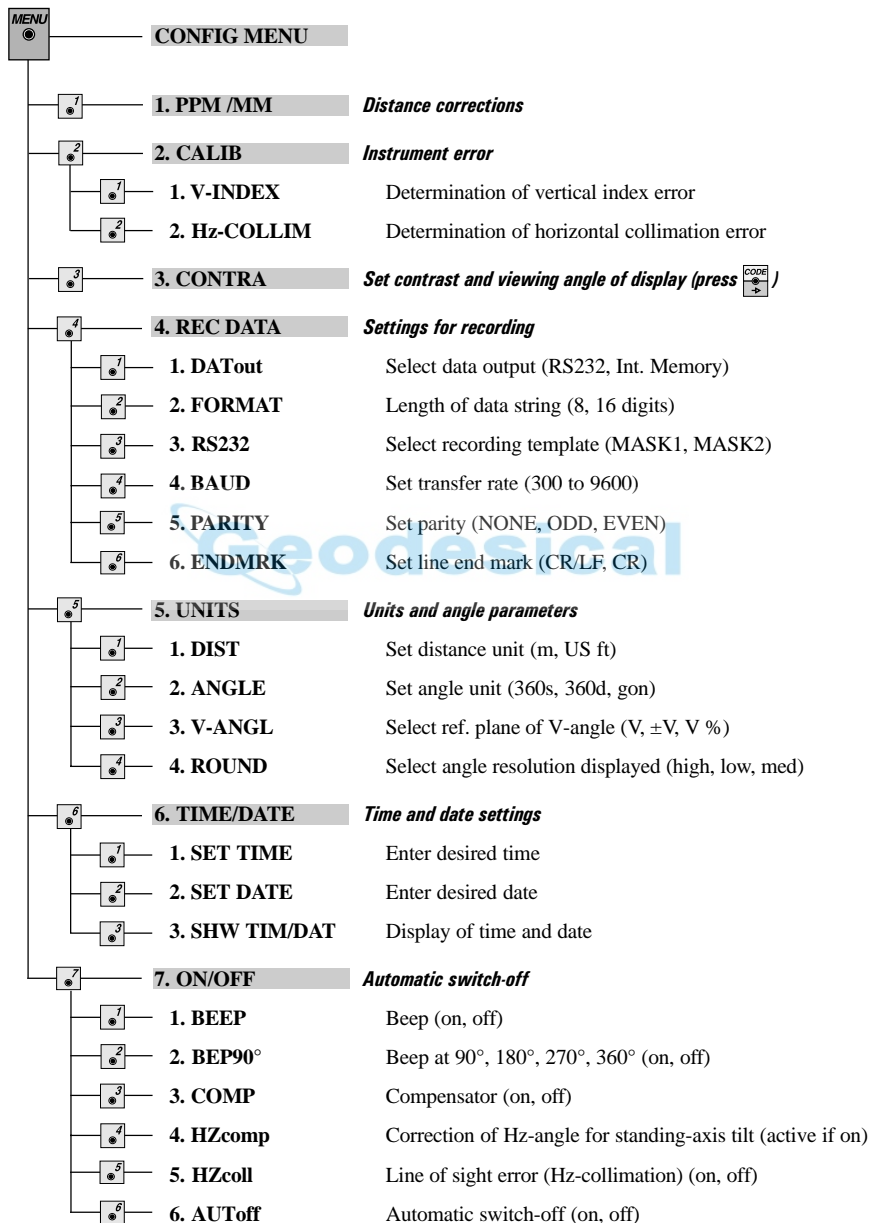

Menu tree (programs)

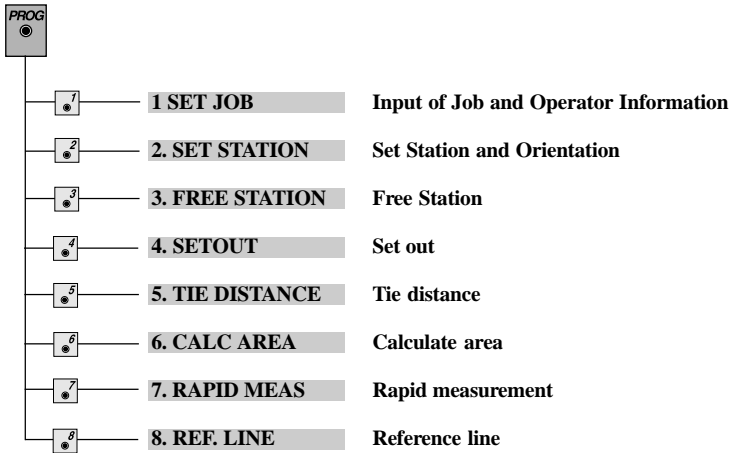

Main menu



- HZ-Settings (SET HZ)** Under **SET HZ** the Hz-angle can be set (manually entered or by turning the instrument to a specific value, then hold the reading).
- Electronic level (LEVEL)** For the exact levelling-up of the instrument.
- Data manager** Under **DATA MANAGER** measurements, coordinates or codes can be entered, deleted and displayed.
- EDM configuration (EDM conf)** Several settings for measuring can be carried out under EDM CONF (only TC805/905/L) (eg. selecting the EDM mode, Guidelight EGL ON/OFF, setting retro tape as target, etc.)
- Testing (TEST)** **TEST** contains different functions specifying status of instrument (e.g. battery etc.)



Measure and record



After switching on and setting up the total station correctly, it is immediately ready for measuring.

Display symbols

Pt	:	22
Hz	:	341°17'10
V	:	87°55'10
	:	3.782

- Pt : Point number
Hz : Horizontal angle
V : Vertical angle
 : Slope distance
 : Horizontal distance
 : Height difference
E : Easting (value right)
N : Northing (upper value)
H : Height
Cod : Code (description)
hr : Reflector height
hi : Instrument height
ppm : Atmospheric distance correction
mm : Prism constant (Leica circular prisms = 0)

Pointing and distance measurement

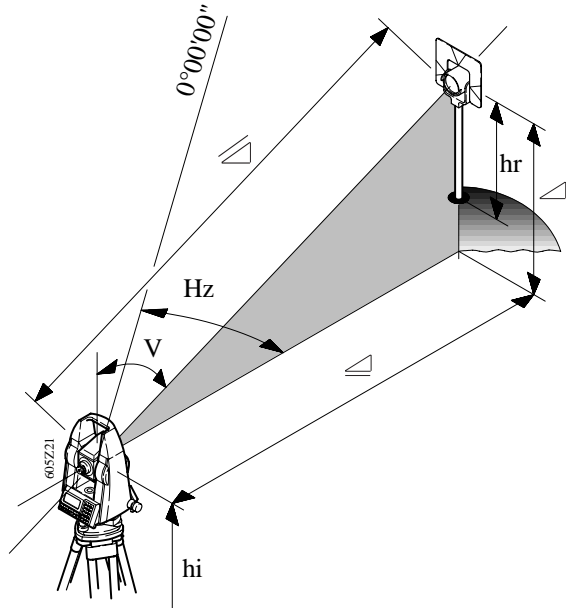

Geodesical

GPH1 prism holder with
GZT4 target plate

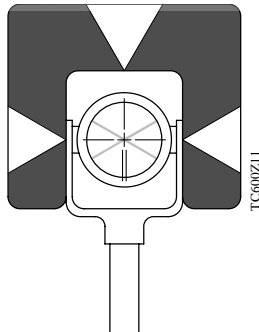

When pointing through windows or if reflecting surfaces are present, incorrect readings may result. For long-range work or for surveys under unfavorable conditions, multiple prisms (e.g. GPH3 triple prism) should be used.



Pt :	1
HZ :	341°17'10
V :	87°55'10
 :	----

Simultaneous determination of distances and angles, including data recording.

The point number is incremented by 1 after each recording.

or



Pt :	1
HZ :	341°17'10
V :	87°55'10
 :	3.782

Distance measurement.



will record the angles and measured distance.

The Hz-angle always refer to the actual pointing direction of the telescope.



Example: for offset or hidden points



The distances and horizontal angles can be measured separately. First determine the distance and then adjust the direction (e.g. for surveying corners of buildings).



will record the data.



The recorded V-angle always refers to the time of the completed distance measurement.

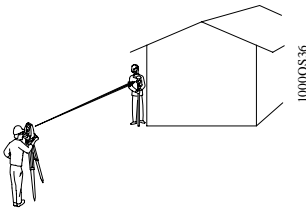

Measuring DISTANCE ()

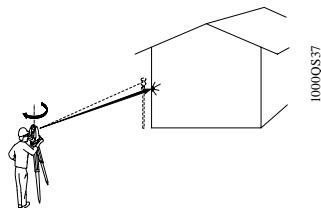

Storing DATA ()

Tracking mode



Press for 2 seconds and the tracking mode is switched on.



Stops tracking mode and returns into single mode.

Display of recorded measurements



```
◇ MENU
  1 . SET HZ      →
  2 . LEVEL      →
  →3 . DATA MANAGER →
```



```
◇ *3 . DATA MANAGER
  1 . INPUT      →
  2 . FIND       →
  →3 . VIEW      →
```



```
√ *3 . VIEW
  →1 . OBSERV   →
  2 . COORDS    →
  3 . CODELIST  →
```



```
Obs   : 0004/0047
                22
Type  :      Meas
      DSP to view
```

Measuring block

Total measured blocks (max. 3000, refer to section "Recording", page 94)



Press to scroll measured data upwards or downwards block by block. By keeping pressed down, measured data are scrolled continuously up or down.



Display of data, line by line within a measurement (block).

Example:

```
Obs   : 0004/0047
Hz    :   98.404
V     :   92.209
  /   :    3.782
```

Measure and record with coding

Codes can be assigned to each measurement to provide additional information to the measured point.

Select a line from the codelist:

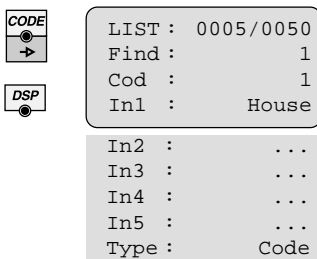

This display will appear only if at least one codeblock is loaded in the code list. Code blocks can be entered via the Data Manager or via RCS232 interface using TCTools.

Codes can be entered directly or selected out of 100 pre-defined codes in the code list. Search for specific codes directly by using the on-line search or assign the first 10 codes of the codelist to the numeric keys ("Quick-Code").

Codes can be of max. 8 characters length.

Alphanumeric code lists can be defined on the PC using TCTOOLS and then transferred to the TC605/TC805/TC905/L unit via RS232 interface.

Codes also can be appended to the code list at the instrument using the menu options:

- DATA MANAGER
- INPUT
- CODELIST

Coding

Input a new code line to the code list

Appending additional codes at the instrument is carried out in the "DATA MANAGER". For the code letters and numbers are allowed.



```
√ * 3 . DATA MANAGER
→ 1 . INPUT      →
  2 . FIND        →
  3 . VIEW        →
```



```
^ * 1 . INPUT
  1 . COORDS      →
→ 2 . CODELIST   →
```



```
√ Code Input
→Cod:      145
In1:      House
In2:      Driveway
In3:      Width
In4:      Start
In5:      End
```



```
Code Input
Append > Yes
```



Toggles between YES/NO.



Confirm input.



Function "Quick-Code"

The function "Quick-Code" provides huge time-savings for measurements with coding. Pressing only one key selects the code, triggers a distance measurement, assigns a code and records the measurement.

First set the following display using the -key to enable the function "Quick-Code".

Pt	:	123
Cod	:	341°17'10
	:	-----
hr	:	1.500

This enables the "Quick-Code" mode in which the first 10 code lines of a code list are assigned to the numeric keys of the keyboard.

They can be called directly by pressing , ..., , . Pressing one of the numeric keys automatically starts the distance measurement, assigns the code and records the data.

Geodesical

There is no need to press any further keys for the first 10 codes in the code list when using this mode.







Assign your 10 most often used codes to the first 10 lines in the code list when using this mode.

Simple code input during measurements

If the code list is empty and no code has been entered via Data Manager, it is possible to enter a new code with maximum 5 additional lines of intermation directly using .

	<div style="border: 1px solid gray; padding: 5px;"><p>∨ CODE EDIT</p><p>→Cod: ?</p><p>In1: CodeInp?</p><p>In2: ?</p><p>In3: ?</p><p>In4: ?</p><p>In5: ?</p></div>
---	---

This procedure is possible as long as no code blocks are entered in the code list. When uploading a code list with TCTools or entering a codeblock via Data Manager, coding will only be permitted entering one code line using .

Alternatively codes can be selected out of the code list by entering "*" ( + ) in the line "Find=" and then using  or  to select the the code.

To find codes quickly and efficiently you may type the first letter or number of the preferred code. It is possible to enter more than one character as search criteria. All codes fulfilling the search criteria will be displayed.

Please refer to chapter "*Coding*" / "*Searching for codes using Wildcards*".

	<div style="border: 1px solid gray; padding: 5px;"><p>List: 0005/0050</p><p>Find = +47</p><p>Cod : -----</p><p>In1 : -----</p></div>
---	--

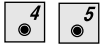

```
List: 0005/0050
Find = +45
Cod : -----
Inl : -----
```

Codes entered in the line "Find= ...", which do not exist in the code list are automatically accepted as code. No further information can be entered for "In1" ... "In5".



```
CODE EDIT
Code recorded
```

Confirming and record the entered code with .



Additional entries to selected code

Up to 100 code blocks can be specified within a code list. Each code block consists of max. six elements, the code and five further elements.

Each element can be defined as input field in order to insert additional information directly in the field. Input fields are defined by a "?" in one or more fields.

Example code block:



```
LIST : 0005/0050
Find =      +5
Code :      500
In1  :      House

In2  : ? Driveway
In3  : ? Width
```

LIST : actual block number in the complete code list (**0005**) and number of loaded code blocks (**0050**)

Find : searches all codes starting with this character(s) ("5" in this example)

CODE : code no. (**500**)

In1 : object to be measured (e.g. **House**)

In2 : exact specification (e.g. **? Driveway**)

In3 : dimension for In2 (**? Width**)

With elements containing a question mark a point-specific alphanumeric value can be entered. The  key switches to alpha characters.



Steps through the codeblock (e.g. Code, In1, ...)



```
List: 0005/0050
Find = +1
Cod : 112
In1  : ?
```



```
CODE EDIT
Cod :      112
->In1 :      ?
In2 :      0
```

Only lines with a "?" can be edited. If no input is made nothing is recorded for that specific field.

For code blocks containing elements without "?", the existing data of the individual elements are recorded.

Recording codes



```
LIST : 0005/0050
Code : +      500
In1 :      House
In2 :      Driveway
In3 : ? Width
In4 : ? Start
In5 : ? End
```



To append new codes to the code list *refer to section "Data management" / "Input of coordinates and codes (INPUT)"*.



Records the selected code or the additional entries and returns to the measuring display.



Returns to the measuring display without recording the code.



All "?" have to be entered or confirmed before the entire code line will be recorded.

Searching for codes using wildcards

In order to find the desired codes fast and directly wildcards are available and explained below. With the input of the search criteria (1, 0, 2) in the following example the relevant codes are more and more narrowed until the desired code is shown. With a high number of codes in the codelist the desired code can be found quickly and easily.





By entering a "*" (, , ) you can search for a specific group of characters.

Combining specific characters (letters, numbers and *) will search for the occurrence of these characters at the specific position of the codes in the codelist.

The "*" permits any character at that position.

Refer also to chapter "Searching for point numbers and multiple recordings".

Example:

List:	0005/0050
Find =	+1
Cod :	1
Inl :	?

Found code blocks:
1, 10, 11, 102, 110





List:	0005/0050
Find =	+10
Cod :	10
Inl :	?

Found code blocks:
10, 102



List:	0005/0050
Find =	+102
Cod :	102
Inl :	?

Found code block:
102

  Scrolling through the code blocks which fulfill the search criteria.

 Viewing single elements of the code blocks.

User Programs



In order to use the software correctly and reliably, you must follow the instructions given in the user manual. You must also adhere to the directions given in the user manual for the product with which you are using the software.

Introduction

The integrated programs enhance the functionality of the TC605/TC805/TC905/L total station. Daily survey work is simplified by using internally stored coordinates. This largely eliminates the risk of entering wrong information in the field. Points with given coordinates or measured points can be used within the programs.

The following programs are installed in the instruments:

- Set Job and User (**Set Job**)
- Set Station and Orientation (**Set Station**)
- Free station (**Free Station**)
- Setting-out (**Setout**)
- Tie distance (**Tie distance**)
- Area computation (**Calc Area**)
- Rapid measurement and recording (**Rapid Meas**)
- Reference Line (**Ref. Line**)



Programs are generally exit using the key .

Point search in programs

With option **IntMem** the coordinates are searched with 1. priority in the COORD area of the internal memory. The entered point number is always searched from the end to the start of the COORD area. With multiple stored and identical point numbers always the last stored number is found.

For points not found within the COORD area, the pointnumber search continues in the OBS area of the internal memory and the user will be notified with the message "PtNr only in Obs".



The message "PtNr not found" will be shown for points which do not exist in the COORD nor in the OBS area.

Set Job



```
√PROG
→1.Set Job      →
  2.Set Station →
  3.Free Station →
```



```
√Set Job
→Job:          JOB1
  Ope:          MUE
  Dat:          27/01/97
```



Inputs are stored by the instrument; program back to the menu item **PROG**.

Jobname and Operatorname can be entered. This is automatically stored in the Obs data range of the internal memory. The information can be read out and used as a information about the next stored measurements.



Data are not linked in any way to the Job.

***Set station coordinates
and Orientation
(Set Station)***

The program "Set Station" is used for setting station coordinates in the instrument. These can be entered manually or can be read from the internal memory.

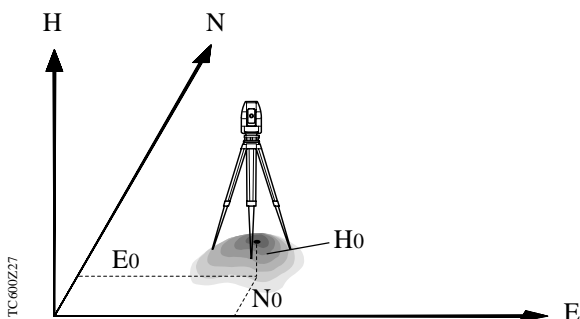

The selected or entered coordinates are stored in the Obs data range of the internal memory. The station coordinates are set simultaneously.

The coordinates are stored in the format PtNr, E, N, H.

Geodesical



```

◇ PROG
1.Set Job      →
→2.Set Station →
3.Free Station →
  
```



```

▽SET STATION
→Get DATA>IntMem
Pt :          0
hi :          0.000
  
```



Optionally select manual input (**Keyb.**) or point search from internal memory (**IntMem**).
Default setting is "IntMem".

Manual point entry



```
√SET STATION
→Get DATA> Keyb.
Pt :          P1
hi :          1.200
```

- point number entry (P1)
- instrument height entry (1.200).



Instrument requires coordinate input.

```
√SET STATION
→E :          150.000
N :          250.000
H :          500.000
```

- Input of Easting (E), 
- Input of Northing (N), 
- Input of height (H), 



Geodesical

```
√SET STATION
•Pt:          P1
E0:          150.000
N0:          250.000

H0:          500.000
hi:          1.200
```



Instrument stores the data in the Obs data range of the internal memory.

For control purposes the actual station coordinates are displayed. They cannot be changed any more. By scrolling with  and  the complete display can be shown.



Read the station coordinates from internal memory (IntMem)

The direct input of the point number and the wildcard search are possible.

```
√SET STATION
→Get DATA> IntMem
Pt : P1
hi : 1.200
```

- point number entry (P1)
- instrument height entry (1.200).

Search for station coordinates with wildcards

If the point number is not known the wildcard search can be used here. By entering a "*" ( + ) instead of a point number the program is branching into a search for all points.

```
√SET STATION
→Get DATA> IntMem
Pt : 1*
hi : 1.200
```

Input "1*" finds all point numbers starting with "1" but with subsequent characters.

```
COOR: 0005/0025
Pt : 10
→hi : 1.200
```

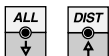

Scrolls the pointnumber fulfilling the search criteria - in this example all points are shown, starting with "1".



Display single elements of the data.



```
√SET STATION
• Pt:          P1
  E0:         150.000
  N0:         250.000

H0:          500.000
hi:          1.200
```

For control purposes the actual station coordinates are displayed. They cannot be changed any more.



```
√SET STATION
REC :
Pt  :          P1
  Station SET
```

The program automatically moves to the "ORIENTATION".



For more details about wildcard search facilities, please refer to chapter *"Data management" / "Searching for pointnumbers and multiple recordings"*.

Orientation of horizontal circle

It is possible to carry out the horizontal circle orientation with internally stored coordinates, manually entered coordinates and manual angle entries. The ORIENTATION is integrated in SET STATION.

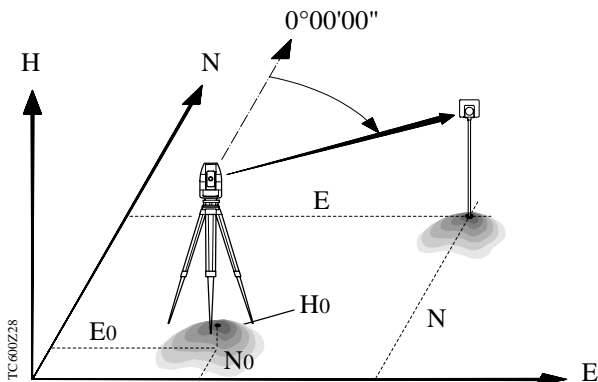



```

vORIENTATION
->Get DATA>IntMem
Pt : 0
    
```



Optionally select manual input (**Keyb.**) or point search from internal memory (**IntMem**) or enter the angle directly (**Angle**)

- Select line to enter the point number entry, .
- Confirm entry (P1), .



```

ORIENTATION
•Pt : P1
Hz : 65°50'00
V : 90°20'12
    
```

ORIENTATION

Orientation
SET

Short display for confirmation: Orientation is set.

Data are stored by the instrument and the program returns to the menu PROG.



The option "**Angle**" acts in the same way as setting the horizontal circle reading in "**SET HZ**".

 **Geodesical**

Free Station

Calculates coordinates, height and horizontal circle orientation of the instrument position using min. 2 to max. 5 known points with coordinates.

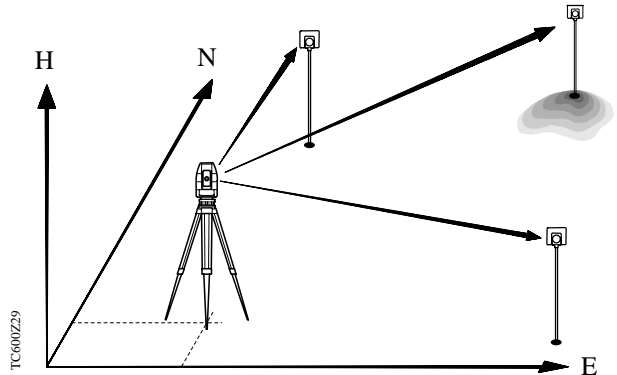

```
◇ PROG
1.Set Job →
2.Set Station →
→3.Free Station→
```



```
√ FREE STATION
→Pt : 0
hi : 0.000
```

Two different methods can be used, which the program automatically recognizes.

Procedure 1

Distances are measured to all points. Station coordinates (E, N, H) are computed using a Helmert-Transformation. The computed standard deviation for the position (mp) is derived from the best fit.

Procedure 2

Not all distances are measured. In this case the shortest measured distance is used to determine the station coordinates.

The point with the shortest distance is **not** used for orientation.

The shortest measured distance must be less than the calculated distance between the 2 target points, otherwise the error message "Bad Configuration" appears and the program terminates.

The computed standard deviation for the position (mp) refers to the accuracy of orientation (mo) used for the shortest measured distance.

Valid for both procedures:

The orientation is calculated by the arithmetic mean of all point orientations.

The calculation of the station height uses only those points with a measured distance and heights not equal zero.

The station height is the mean of the single heights.

The standard deviations for the orientation (mo) and the station height (mp) are computed using residuals derived from the arithmetic mean.



Input of station number and instrument height (*for alphanumeric point entry see chapter "Settings" / "Entering point number and reflector height"*).



Confirm input.

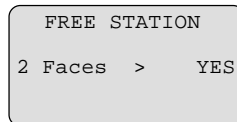

Selection: Yes: 2 Faces
No: 1 Face



Confirming the selection.

Definition of target points

Point entries can be carried out in two ways:

1. IntMem: Points are searched in the data memory.
Wildcards can be used.
2. Keyb.: Manual entry of coordinates

```
FREE STATION
Get DATA> IntMem
→Pt :      10
hr :      1.500
```

Input of point number and reflector height.



Confirm input.

```
FREE STATION (1) — first point
Hz : 165°50'00
V : 90°20'51
△ : ----
```

Showing the measuring display; aim first point.



Measure and record the data simultaneously, or



measure distance and continue without recording, or



use angles only and continue without recording.

```
FREE STATION 1
Other face
```

Change to the other face.



Measure and record the data simultaneously, or



measure distance and continue without recording, or



use angles only and continue without recording.

```
◇ FREE STATION (2) — second point
Get DATA> IntMem
→Pt :      45
hr :      1.200
```

Continue likewise with the second point.
 Enter point number and reflector height and confirm
 with .

Measuring and recording additional points is carried out
 in the same way.

After 2 measurements the results can be computed or
 the measurements can be continued with additional
 points (max. 5 points).

When using more than 2 points, the option to compute
 the position is made for each additional point used.

```

  FREE STATION
  Calculate>      No
  
```



Selection: Yes/No



Confirming selection.



Result indication

```

  √ FREE STATION
  •Pt :          5
  E0 :          12.142
  N0 :          7.344
  
```

```

  H0 :          102.501
  Ori :        +87°23'11
  hi :          1.250
  mp :          0.012
  mh :          0.034
  mo :        +0°01'05
  
```

Ori : Orientation correction
 hi : Instrument height
 mp : Standard deviation of position
 mh : Standard deviation station point height
 mo : Standard deviation orientation



Scrolling line by line.



Page the result display.

Indication of residuals:

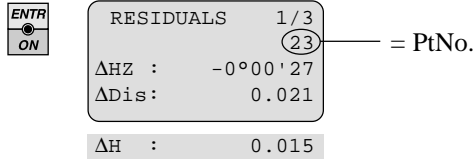

For each measured point the relevant residuals can be displayed.

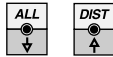

Scrolling the measured points.



Page the elements of the residuals.

If a distance was not measured the residual for $\Delta Dist$ is zero.



Stores the station coordinates and orientates the horizontal circle. Returns to the PROG menu.

If the program is exit with  the following message appears:

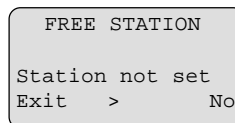

Selection: Yes/No



Confirming the selection.

Setting out (Setout)

The setting-out technique can be based on the coordinate system of the points to be set out. The program calculates setting-out elements from manually entered or stored coordinates and station data. The option to enter angle and horizontal distance also exists.

Before you start setting out, make sure that the correct station point is set and the instrument has been oriented, when using coordinates.

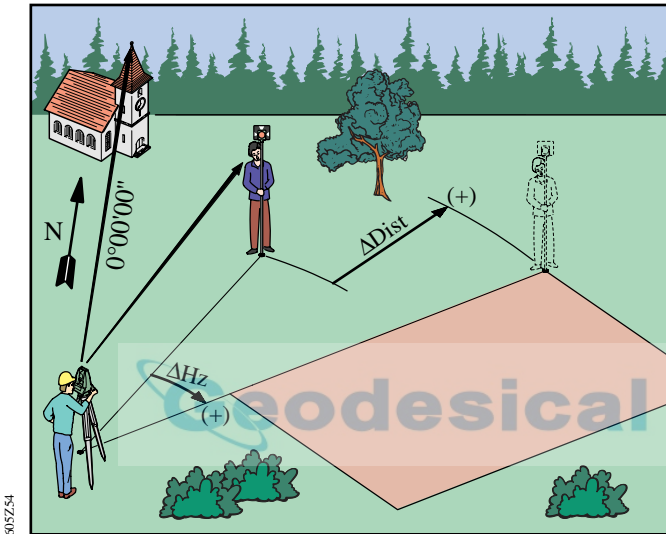

The "Setout" program supports the polar setting out technique. The divergence between the computed direction and the measured direction is displayed first.

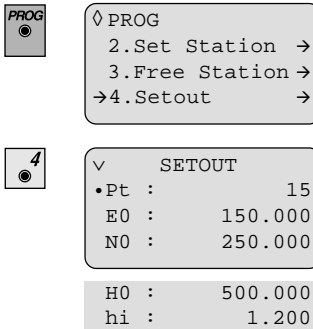

The present station coordinates are displayed for inspection, but cannot be changed here.



Pt :	0
Δ HZ :	82°15'30
Δ :	----
Δ :	----

The instrument is now ready for the first setout.

The desired setout point must be entered:



√	SETOUT
Get DATA>	IntMem
→Pt :	105
hr :	1.500
Off :	0.300

Input of point number, reflector height and height offset **Off**. The amount of **Off** is added to or subtracted from the height to be set out, in accordance with its sign. This takes account of infill, etc

The entered point number is local within the application "Setout" and does **not** overwrite the system point number.

The options exist to search for coordinates in the COORD and MEAS data range (**IntMem**), for manual entries after switching to **Keyb** or for manual entries of angle and horizontal distance (**Angle**). It is possible to use "Wildcards" (refer to section "Data management" / "Searching for point numbers and multiple recordings").



Pt :	105
Δ HZ :	-0°05'30
Δ :	1.015
Δ :	0.025

Turn instrument until Δ HZ = 0°00'00" (0.0000gon).

Repeat the measurements of the distance with  until the displayed difference in distance (Δ) is within the required accuracy, i.e., close enough to "zero".



Records the measured data in the Meas data range.



The next point is selected.

Tie Distance (Missing line)

With the program "Tie distance" the slope distance, horizontal distance, height difference and azimuth between two points is computed.

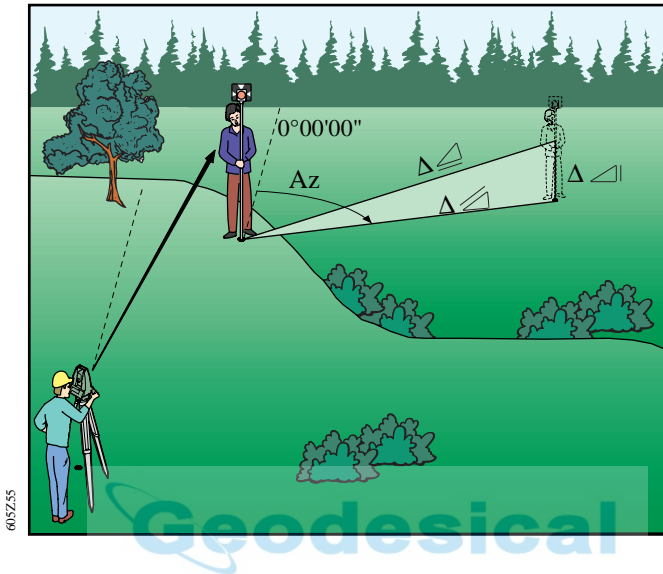

```



◇ PROG
 3.Free Station →
 4.Setout       →
→5.Tie Distance →
    
```



```

▽ TIE DISTANCE
•Pt :      15
E0 :    150.000
N0 :    250.000

H0 :    500.000
hi :     1.200
    
```

The displayed values show the station coordinates. The station point number is in the first line and therefore appears not directly on the display. With  /  you can scroll the displayed station data.



```
◇ TIE DISTANCE 1
Get DATA> Keyb.
→Pt :      105
hr :      1.500
```

Start display:

- select desired method (**Keyb.**, IntMem, OnLine)
- Input of point number
- Input of reflector height (*for alphanumeric point entry see chapter "Settings" / "Entering point number and reflector height"*).

The points can be determined using three different methods:

OnLine: measurements to target points

IntMem: from coordinates read in the internal memory

Keyb: from coordinates entered manually

It is possible to combine all three methods.

The program supports the polygonal technique, i.e. the calculation of the tie distance between the two last points which were measured, entered or selected.



Confirming selection.

```
◇ TIE DISTANCE 1
E :      15.200
N :      85.000
H :      512.500
```

Input of Easting

Input of Northing

Input of Height



Continue to next point/tie distance. Point two is now set as point one and the following measurement or the following data entry is used for the second point and so on.



```
◇ TIE DISTANCE 2
Get DATA> IntMem
→Pt : 106
hr : 1.400
```

Input of point data for tie distance 2:

- Select desired method (**Keyb.**, IntMem, OnLine)
- Input of point number
- Input of reflector height (*for alphanumeric point entry see chapter "Settings" / "Entering point number and reflector height"*).



```
◇ TIE DISTANCE
Az : -0°05'30
△/ : 15.241
△/ : 11.025
```



```
◇ TIE DISTANCE
Pt : 105
Pt : 106
Az : -0°05'30
```



```
◇ TIE DISTANCE
△/ : 15.241
△/ : 11.025
△/ : 1.725
```

- Az : Display of azimuth
- △/ : Display of slope tie distance
- △/ : Display of horiz. tie distance
- △/ : Display of height difference



```
TIE DISTANCE
Program End
```

Termination of program and back to the PROG menu.

Area computation (Calc Area)

This program computes an area built from points which are connected by straight lines (eg, points 1...8). The number of points is unlimited. Points can be defined from continuous measurements (**OnLine**), from manual coordinate entries (**Keyb.**) or from existing point coordinates in memory (**IntMem**).

Each time a new point is defined the user can select one of these three options.

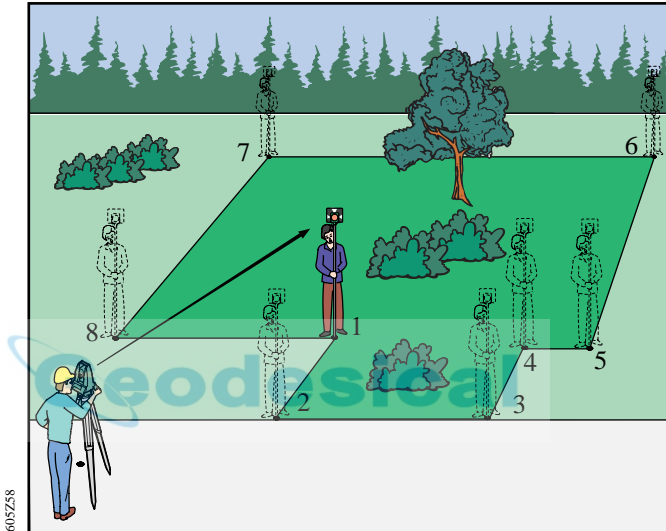

```

◇ PROG
4.Setout      →
5.Tie Distance →
→6.Calc Area  →
  
```



```

∨ CALC AREA
•Pt :          5
E0 :    120.000
N0 :    240.000

H0 :    550.000
hi :     1.200
  
```

The present station coordinates are displayed for inspection, but cannot be changed here.



```

√ CALC AREA
m^2 : 0.000
ha : 0.000
PtCnt: 0

```

The result display is shown.



Input of point number, start with the first point.

```

√ CALC AREA 1
Get DATA> IntMem
→Pt : 1
hr : 1.400

```



Starts to retrieve the coordinates for the entered point from internal memory. Confirm with .

Or:



```

√ CALC AREA 1
Get DATA> Keyb.
→Pt : 1
hr : 1.400

```



```

√ CALC AREA 1
→E : 15.200
N : 85.000
H : 512.500

```

Manual input of coordinates.



Confirming the inputs.

or



Back into menu CALC AREA without using the inputs.

Press  to enter a new point.



```
√ CALC AREA
m^2 : 1178.185
ha : 0.118
PtCnt: 4
```

The polygonal area is closed to the start point.
Display of area in m² (ft²) and hectare (acres) as well as number of used points.



For computing an area minimum three points must be used.



Continue with further points.



```
CALC AREA
Program End
```

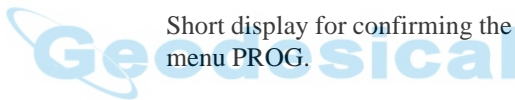

Short display for confirming the termination. Back to menu PROG.

Conversion factors used

$$1 \text{ ft}^2 = 0.092903 \text{ m}^2$$

$$1 \text{ acre} = 0.404686 \text{ ha}$$

Rapid measurement and recording (Rapid Meas)

This program enables quick measurements with coding and data recording. It is designed for fast and easy data logging using a minimum of keyboard interaction. This program is ideal for high density tacheometry with limited coding requirements (e.g. tacheometry for volume determination, contours in open field, etc. ...).



```
◇ PROG
5.Tie Distance →
6.Calc Area →
→7.Rapid Meas →
```



```
▽ RAPID MEAS
•Pt : 5
E0 : 120.000
N0 : 240.000

H0 : 550.000
hi : 1.200
```

The present station coordinates are displayed for inspection, but cannot be changed here.

Measurement procedure

Switches to tracking mode; it is now permanently active. Distances are measured with 0.5-second interval (TC605/L) or 0.3-second interval (TC805/TC905/L). The measurements are recorded in the measurement-data range .

The reflector must be sighted so that the Hz- or V-drive is continuously in motion until the reflector has been targeted with the accuracy required. The data are recorded as soon as the change between the Hz- or V-angle amounts to less than 16" (50^{cc}) between two valid distance measurements.

If, after this recording, the instrument remains in the rest position, no additional data are recorded even though the distance continuous being measured.

The recording mode is reactivated after there has been a change of at least 5' 24" (= 0.1 gon) to the last recorded horizontal direction.

The -key can be used at any time during the program to select or enter coding.



```
DIST*TRACKING
ppm : 0
mm : 0
```

Above display appears for a moment.

The program activates the Tracking Mode automatically.

```
Pt : 1
Hz : 13.672
V : 100.261
/ : 2.803
```

Display of measured values depending on selected display mask.



```
REC :
Pt : 1
```

Measurement is accepted and stored. Data recording is confirmed by a double Beep.

Subsequently, the point number is automatically incremented by 1.



```
RAPID MEAS
Program End
```

The program is terminated.
Back into menu PROG.



This program requires the prisms to be sighted quickly and a good experience in observations techniques. The EDM is permanently switched on, and therefore power consumption is greater than usual.

Reference Line (Ref. Line)

Using this program it is possible to set-out or checking building lines, straight sections of streets, simple groundworks etc.

In relation to a known base line (this example uses an existing boundary line of a building site) a reference line can be defined. The reference line can be offset parallel to the base line and also rotated on the first base point.

With the following example, this application is explained and illustrated.

Here we have a building site with the defined boundary lines (1, 2, 3, 4). For the new building the building lines should be determined in such a way that the extrapolations of the building line can be set-out without problems (even with possible poor visibility due to objects on the set-out building line). Because the building line to the west is set-out perfectly parallel to the left boundary line (1 - 2) it should be used as the reference line.

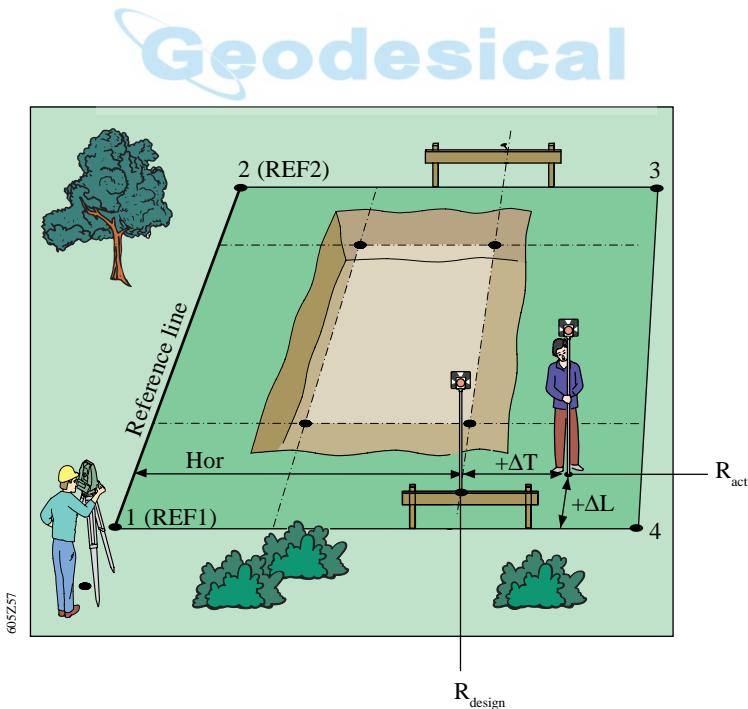



```

^PROG
 6.Calc Area   →
 7.Rapid Meas →
 →8.Ref. Line  →

```



```

√ REF. LINE
•Pt :          1
E0 :          0.000
N0 :          0.000

H0 :          0.000
hi :          0.000

```

The present station coordinates are displayed for inspection, but cannot be changed here.



```

√ REF. LINE  1
Get DATA> IntMem
→Pt :          REF1

```

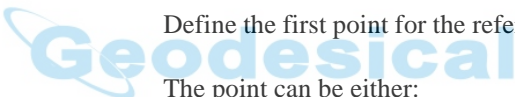

Define the first point for the reference line.

The point can be either:

- measured directly in the field (Get DATA>**ONLINE**)
- entered manually (Get DATA>**Keyb.**)
- retrieved from memory (Get DATA>**IntMem**).



Confirming the input.

Point "REF1" was first defined in the DATA MANAGER. This point is on a boundary line and defines the start of a reference line.



Selection: stored point number (**IntMem**),
 manual input (**Keyb.**) or
 measured coordinates (**Online**).

Input of point number.



Confirming the input of the first point for the reference line.



```
√ REF. LINE      2  
Get DATA> IntMem  
→Pt :           6
```

Input of second point number ("REF2")



Confirming the input of the second point for the reference line.

If the same coordinates are entered inadvertently for the first and the second point the error message below appears and the program requires the reentry of the second point.



```
REF. LINE  
  
Baseline  
too short
```



Entered points are only valid if the difference of the EAST or NORTH coordinates are minimum 2 mm. Please note that short base lines (mm to cm range) can result in inaccuracies.

The program REFLINE offers three additional parameters to modify a reference line.

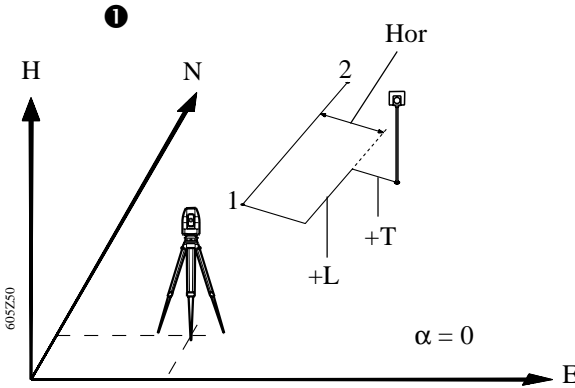

Variant ① shows a simple translation by value "Hor", rotation angle " $\alpha = 0$ ". Positive values for "Hor" correspond to a horizontal shift to right in relation to the direction of the base line (1-2).

Geodesical

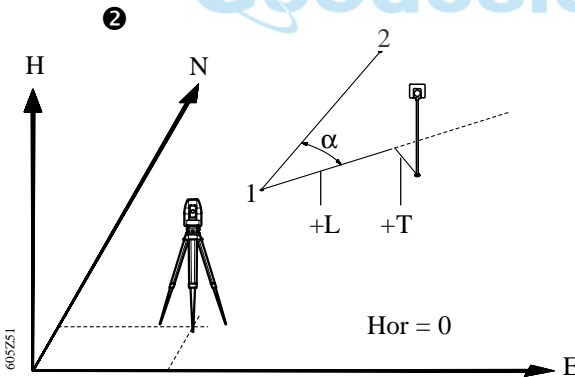

Variant ② shows a simple rotation on the base point "1", i.e. valid for the horizontal offset "Hor = 0". A positive angle input (i.e. Ang > 0) means a clockwise rotation of the base line.

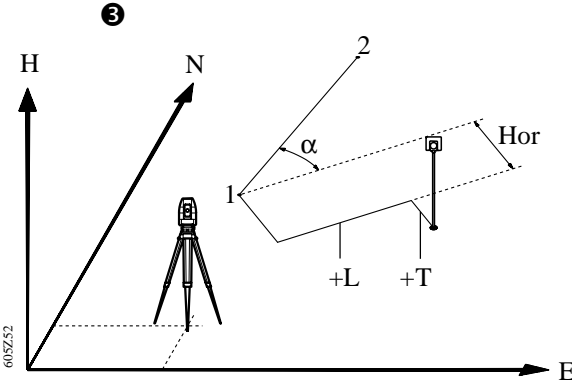

Variant ③ shows a combination of rotation on the 1. point and a horizontal offset of the rotated base line. The perpendicular offset to the defined reference line is specified with "T" and the longitudinal offset to the base point "1" is specified with "L".

√	LINESHIFTS	2
→	Ang:	+0°00'00
	Hor:	3.000
	Ver:	0.000

Hor: Offset to the right or left in relation to the direction of the base line (Hor > 0 shifts right, Hor < 0 shifts left).

Ver: The base line can also be shifted vertically by entering a vertical offset (Ver > 0 shifts upwards, Ver < 0 shifts downwards)



Using different elevations for start- and endpoint generates a slope. This slope is also applied to the rotated (α) and/or shifted (Hor) line.

Setting out a driveway

known:

- Office building with projected driveway and specified slope.
- Base line 1-2 (e.g. street)

Procedure:

- Assign slope of driveway with the help of height coordinates.
- Aim reflector.
- Output of ΔT , ΔL , ΔH

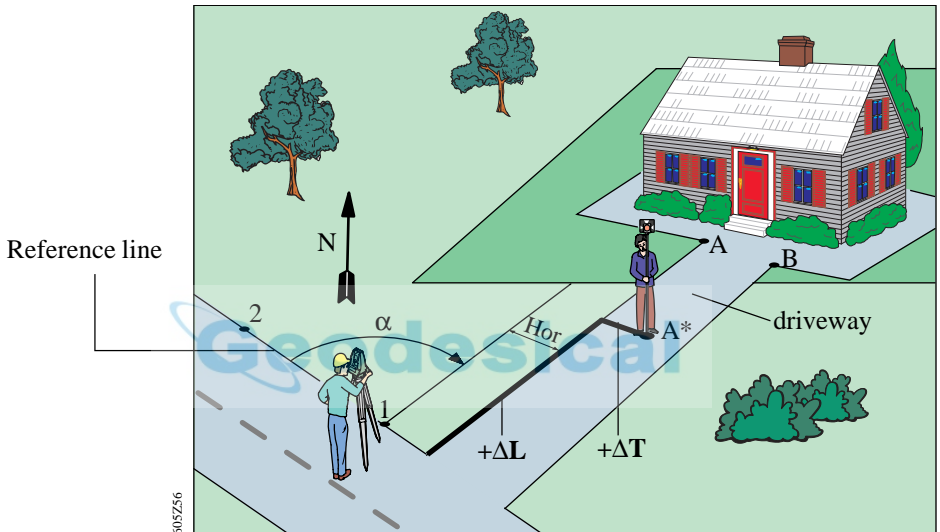

The height of base points "1" and "2" can be entered in such a way that the slope of the base line corresponds to the slope of the driveway. Subsequently, the rotation angle $\text{Ang} = \alpha$ is entered turning on point "1" the base line with constant slope angle so that the line is parallel to the driveway.

When starting a measurement at position "A*" the instrument determines automatically the offset (ΔT) from the edge of the driveway and the difference to the designed height " ΔH ".

The prism pole can now be moved towards the edge of the driveway until finally " $\Delta T = 0$ " is shown, marking the line for the edge of the driveway.

The prism pole can now be moved up or down until " $\Delta H = 0$ ". The bottom of the prism pole indicated the final level of the driveway surface. This level can be marked as a reference for the builders.

ENTR ● ON	Pt : 3
	ΔL : ----
	ΔT : ----
	ΔH : ----

Measuring display indication.

DIST ● ↑	Pt : 3
	ΔL : 22.177
	ΔT : 1.554
	ΔH : 30.204

DSP ●	Pt : 3
	ΔH_z : $-2^{\circ}04'55$
	$\Delta \triangle$: 13.672
	$\Delta \triangle \triangle$: 0.702

Vertical and horizontal offsets from the position of the reflector are shown on the display.

" ΔL " is the distance from reflector to the start point of the reference line in relation to the first base point.

The offset " ΔT " shows the offset from the edge of the driveway.

In the Tracking mode the displayed values for the reflector position are shown continuously.

With key **DSP** the HZ-angle difference and the horizontal and height difference can be displayed.

This display sets out the position defined by L and T using the polar stakeout method.



```
√ REF. LINE
Pt :      4
→L :     10.000
T  :      5.000
```

With key  a target point can be directly entered. The point is specified from offsets (L, T) in relation to the reference line. If the reference line is shifted and turned the entered values for "L" and "T" refer to the shifted line.

As a result, "L" means an offset into the direction of the positive reference line. "T" means a horizontal offset in relation to the reference line (+T = right, -T = left of the line).

L: Longitudinal
T: Transversal

In our example "L = 10.000" shows the prism pole is 10 metres from the first point of the reference line and "T = 5.000" shows the prism pole is 5 metres to the right of the defined reference line.



```
REF. LINE
Program End
```

By pressing key  threefold the program proceeds step by step from the measuring display into the LINESHIFTS menu for display of the reference line definition and subsequently returns to the PROG menu.

Settings

Entering point number and reflector height

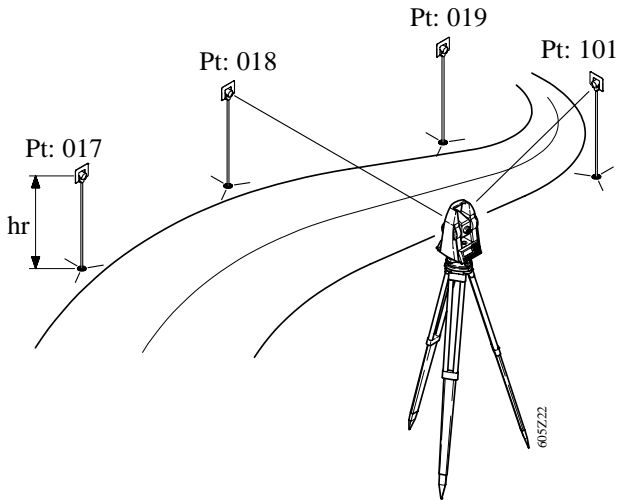

∇Indiv. Pt/Pt/hr	
iPt	101
→Pt :	18
hr :	0.000

Point number (Pt)

To enter any point number use the alphanumeric keyboard.

This point number is recorded with the measurements and is always automatically incremented by "+1" after recording.

To enter a new point number, just overwrite the existing one. You don't have to delete the old one before.

For alphanumeric entry of point number refer to *section "Operating concept" / "Numeric / alphanumeric entry mode"*.

Alphanumeric point numbers, like "A1" cannot be incremented higher than "A9". Reaching "A10" the program displays a WARNING and this point number has to be entered manually. You can avoid this by entering the point number "A01" at the beginning.

Individual point number (IPT)

To easily measure a point between two running points, there is the possibility to enter an individual point number. This point number is not incremented and automatically be reset to the actual point number after recording.

For point search refer to *section "Data management" / "Searching for point numbers and multiple recordings (FIND)"*.



The **reflector height** is entered under **hr:**

Setting the horizontal circle (Hz)

1st variant

= sets Hz to $0^{\circ}00'00''$ by entering the Hz-value directly from the keyboard.



```
√MENU  
→1.SET HZ →  
2.LEVEL →  
3.DATA MANAGER →
```



```
MENU*1.SET HZ  
Hz : 0°00'00  
Hz input or  
ENTR to hold
```

Type in: $0^{\circ}00'00$



Hz - direction is held on $0^{\circ} 00' 00''$ (0.0000 gon).

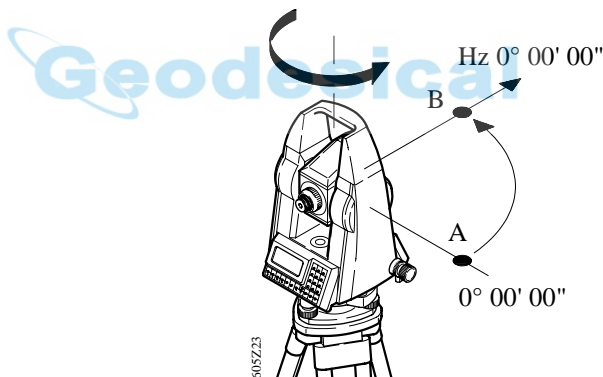

Aim at point B.

```
MENU*1.SET HZ  
Hz : 0°00'00  
  
ENTR to release
```



The Hz-angle to the new point (B) is now $0^{\circ} 00' 00''$ (0.0000 gon).

Return to measuring display.

2nd variant

= sets Hz to a specified value by turning the instrument



```
√MENU
→1.SET HZ      →
 2.LEVEL       →
 3.DATA MANAGER →
```



```
MENU*1.SET HZ
Hz :      0°00'00
HZ input or
ENTR to hold
```

Turn instrument until required angle (e.g. 45°00'00" , 50.0000 gon) is indicated.



Hold value.

Aim at the corresponding point.

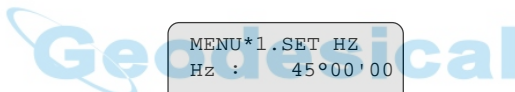

```
MENU*1.SET HZ
Hz :      45°00'00
ENTR to release
```



Release selected Hz.

The target point Hz is now 45°00'00" (50.0000 gon).

Setting the display mask (DSP)

Depending on desired use, four different display masks can be selected on the TC605/TC805/TC905/L unit.

Display of mask 1 :



Pt	:	1
Hz	:	341°17'10
V	:	87°55'10
	:	3.782

Point number
Horizontal angle (Hz)
Vertical angle (V)
Slope distance

Display of mask 2 :



Hz	:	341°17'10
V	:	87°55'10
	:	3.780
	:	0.128

Horizontal angle (Hz)
Vertical angle (V)
Horizontal distance
Height difference

Display of mask 3 :



Pt	:	1
E	:	-2.514
N	:	3.580
H	:	0.137

Point number
Easting
Northing
Height

Display of mask 4 :



Pt	:	12
Cod	:	A4
	:	3.780
hr	:	0.137

Point number
Code number
Horizontal distance
Reflector height

The selected display mask is set automatically.

Data management (DATA MANAGER)

DATA MANAGER contains additional functions enabling the input and check of data in the field.



◇ MENU
1 . SET HZ →
2 . LEVEL →
→ 3 . DATA MANAGER →



√ * 3 . DATA MANAGER
→ 1 . INPUT →
2 . FIND →
3 . VIEW →

4 . DELETE PNT →
5 . DELETE ALL →

The following additional functions are available:

- Input of codes and coordinates (**INPUT**)
- Searching for point numbers and multiple recordings of identical point numbers (**FIND**)
- Display of stored data (**VIEW**)
- Erasing measured data, coordinates and codes in the codelist (**DELETE PNT**)
- Erasing the complete range of the selected file (**DELETE ALL**)

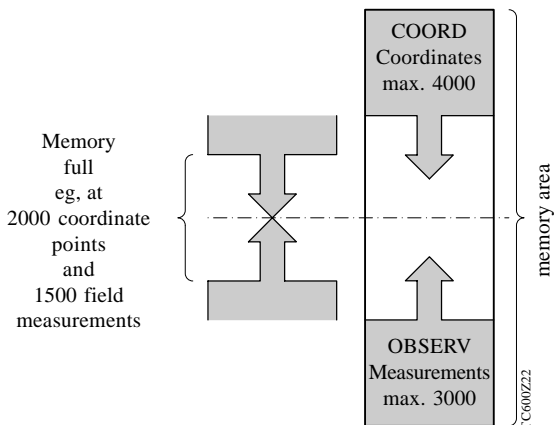

Input of coordinates and codes (INPUT)

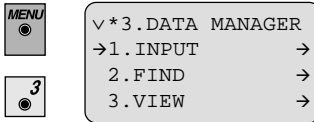

Coordinates can be entered via the keyboard and appended to the existing coordinates (FIXPOINTS) and codes can be appended to theodelist.

Coordinate entry (COORDS)

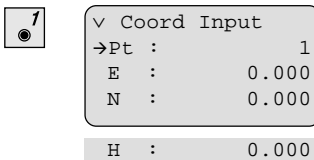
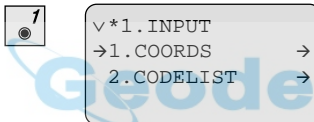

Confirm data entries.



Confirm the display and store the coordinates.



Quit the function.

Code input (CODES)

```
√ *1. INPUT
  1. COORDS      →
  →2. CODELIST   →
```

2

```
√ Code Input
→Cod:          1
In1:           0
In2:           0
In3:           0
In4:           0
In5:           0
```

Input for a new code.

Up to 100 code blocks each with 6 elements can be specified. The newly entered code is appended to the existing list.

 Confirm the inputs in each individual line.

ENTR
ON

ENTR
ON

```
Code Input
Append > Yes
```

ENTR
ON

/

CODE
→

ENTR
ON

Confirm **Yes** : The codes append to the code list.

No : Returns to input mode without recording.

ESC

Quit the function.

Searching for point numbers and multiple recordings (FIND)

This function enables display of data blocks, searches for point numbers and multiple recordings of the same point numbers, including the use of "Wildcards".

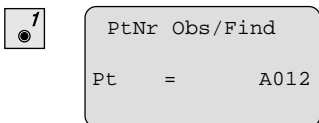
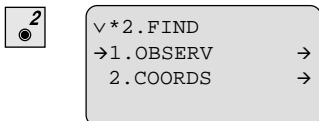
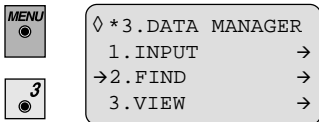

Enter the point number to be searched for.

 Starts the search for the point number. Always the last stored point within the data range is found.

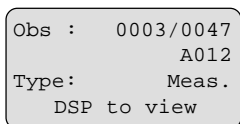

 View of single elements.

 Quit submenu.

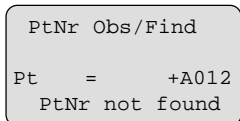

Error message if point number was not found.

Delete error message with .

This searching procedure applies for both, the OBSERV and for the COORDS data range.

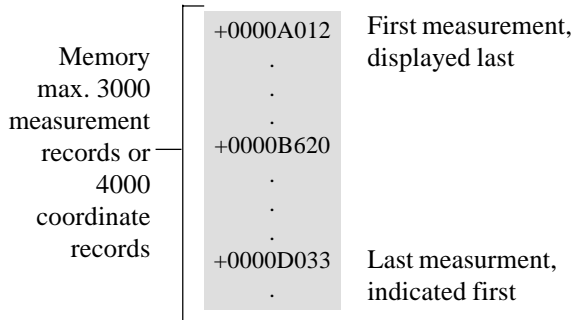

Wildcard search for point numbers

Point numbers can be searched in application programs or in the data display using "Wildcards". They can be used to search for specific character groups or character sequences.



Example:

- Enter A this will search for all point numbers starting with "A" or "a".
- Enter A*5 this will search for all point numbers starting with "A" and "5" at the third position from left.
- Enter ***A this will search for all point numbers with "A" or "a" in fourth position from left.

Searching for several data blocks with the same point number

If a specific point number is shown, the cursor keys can be used to scroll further points fulfilling the wildcard search criteria. The direction of search is always from the last stored point towards the first point.



PtNr Obs/Find

PtNr not found

Warning if point number was not found.

Delete warning with .



Quit the function.

The logo for "Geodesical" features the word in a light blue, sans-serif font. A stylized blue ring or orbit surrounds the letter "G".

Display of stored data (VIEW)

Measuring data (**OBSERV**), fixed-points (**COORDS**) and code lists (**CODELIST**) can be selected individually.

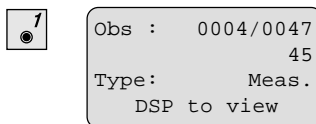
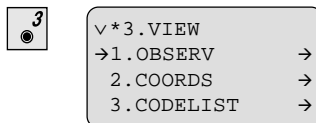
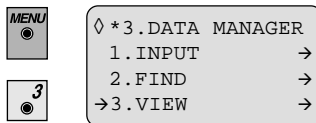

Scrolls data block by block upwards and downwards. Always starts with the last data block (eg, **0047**) within the selected data range (**OBSERV**; **COORD**; **CODELIST**).





Viewing the single elements.

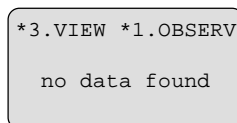

Quit sub-program.

If the file **OBSERV** was deleted or if this data range contains no data the following display appears:



Delete warning with .

Delete measurements, coordinates and codes (DELETE PNT)

In all three options, the blocks stored in the total station are indicated:

- Measurements (**OBSERV**) from measuring range
- Coordinates (**COORDS**) from coordinate range
- Code blocks (**CODELIST**) from code list

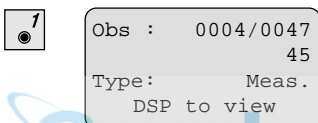
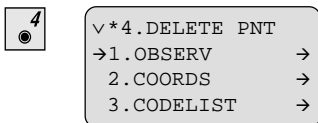
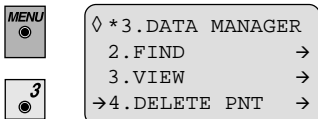

Scrolling to the point to be deleted.



Viewing the single elements.

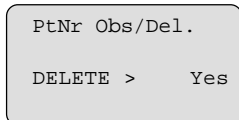
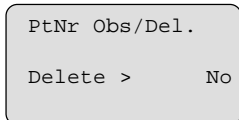

The selected block is deleted.



Quit the function.

Delete the complete range of measurements, coordinates and codes (DELETE ALL)

All points in the data range OBSERV (measured data), COORDS (coordinates) und CODELIST (code lists) can be deleted. Each data range can be deleted individually.



```
^*3.DATA MANAGER
3.VIEW      →
4.DELETE PNT →
→5.DELETE ALL →
```



```
√*5.DELETE ALL
→1.OBSERV      →
2.COORDS       →
3.CODELIST     →
```



```
Erase Data

Nr of Blks:   35
Erase >     No
```



Toggles between YES/NO.



The complete data range is deleted.



Quit the function.

EDM Configuration (EDM CONF)

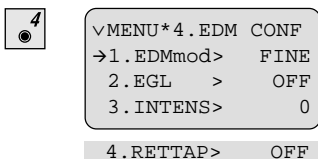
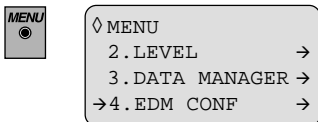

Only with the TC805/L and TC905/L instruments the EDM configuration is possible.

1. EDM mode

Selecting measuring mode FINE or RAPID.

Geodesical

Mode	Accuracy	Meas.time
FINE	2 mm + 2 ppm	2.5 sek.
RASK	3 mm + 2 ppm	0.9 sek.

2. EGL (Guide Light)

The optionally available Guide Light EGL1 consists of two coloured blinking lights in the telescope of the total station. All TC805/TC905 instruments can be equipped with this Guide Light. The person at the prism can be guided by the blinking lights directly to the line of sight. The lights can be sighted up to 150 m away from the instrument. Stake out will be much easier with EGL1.

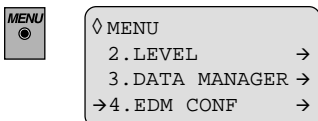



```

√MENU*4.EDM CONF
→1.EDMmod> FINE
 2.EGL > OFF
 3.INTENS> 0

```



Turns the Guide Light (**EGL**) ON or OFF.

To achieve best performance, when using the Guide Light, the intensity should be adjusted for different light conditions (*see chapter "3.INTENS"*).



Confirm the selected value.



Menu option only active with installed EGL1.

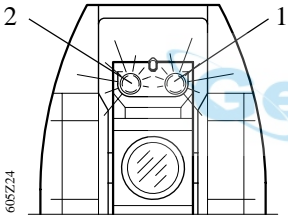

1 Exit for blinking red LED

2 Exit for blinking yellow LED

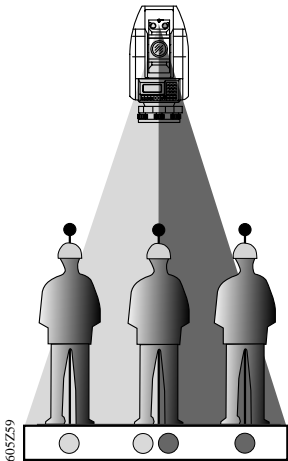

At a target distance of 100 meter (330 ft) a red/yellow blinking cone of light at both sides with a width of 6m (20 ft) each is formed. As a result, guiding to the line of sight of the instrument is much easier and faster.

Between both cones of light an about 30 mm wide sector is created. Within this sector both colours are blinking simultaneously. In this case the prism is already right in the line of sight.

Operating range: 5 - 150 m (15 -500 ft)

Divergence: 12 m (40ft) at 100m (330 ft)

3. INTENS

Using the Guide Light EGL a corresponding value for the intensity can be set.
Settings "0", "1", or "2" are possible.

4. RETTAP

Sets the EDM into a mode to measure to prisms or reflector tapes (= retro tape; only possible with TC805/TC905/L instruments).

One of two different reflector types can be selected:

ON: Set the retro tape target as reflector

OFF: Set the prism as reflector



Pay attention to the correct setting: retro tape and prism have different prism constants. Switching from prism to retro tape will set the internal prism constant for Leica retro tapes automatically to 0.34mm, but the displayed prism constant shows "mm=0.000". Is the EDM switched from retro tape to prism, the last entered value for the prism constant is valid again.



The retro tapes should always be attached in the preferential direction (Leica logo readable acc. to fig.).

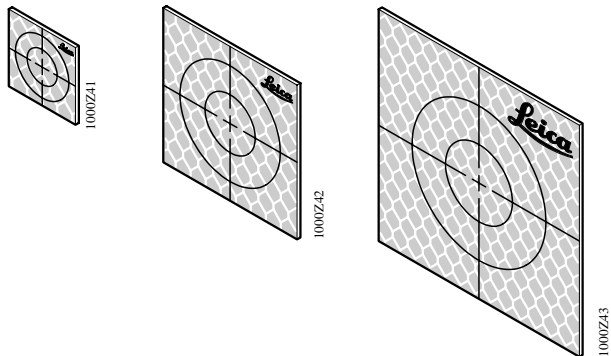

*Available retro tapes,
attached in the preferential direction.*

Retro tapes can be attached permanently to an object for the purposes of monitoring or for frequent repeat measurements. A retro tape may also be useful for the once-and-for-all marking of a point which is difficult to access.

Normally, measurements are still possible up to a horizontal or vertical inclination of $\pm 45^\circ$. Inclined measurement will reduce the range performance. Best performance is achieved when sighting perpendicular to the surface of the retro tape.

Special features

- No loss of accuracy when retro tape is perpendicular to the line of sight
- Measurement precision $\pm 3\text{mm}$ when retro tape is at 45° .
- For short ranges of up to 10m (33ft) the additional lens 632 364 is required. (Measuring error without additional lens $> 10\text{mm}$). It is important that the additional lens is placed to the instrument in the correct position (aperture vertically) !

Geodesical

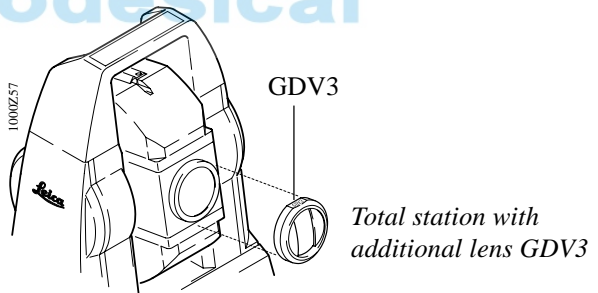

Technical data for measurements to retro foils

Target-mark size [mm]	Range [metres]	Accuracy * (standard deviation)
20 x 20	2 to 40	3 mm
40 x 40	20 to 100	3 mm
60 x 60	60 to 120	3 mm

* The accuracies quoted are valid when the retro tape is targeted at an angle of up to 45° .

Testing the instrument

Test functions are for displaying instrument parameters and status.



```
^MENU
3 . DATA MANAGER →
4 . EDM CONF      →
→5 . TEST         →
```



```
√MENU*5 . TEST
→INTENSITY      →
  BATTERY        7
  TEMP °C        23
```

Battery and instrument temperature

After the submenu has been called, the instrument temperature and the battery status is displayed.

```
√MENU*5 . TEST
→INTENSITY      →
  BATTERY        9
  TEMP °C        23
```

9 = Battery full
1 = Battery low

Low battery charge is indicated with the warning "**Battery low**".

With low battery charge, distances cannot be measured and the instrument switches off automatically.

EDM Signal (INTENSITY)

```
√MENU*5.TEST
→INTENSITY →
BATTERY 7
TEMP °C 23
```



```
*INTENSITY
>■■■■■■<
28%
```

Under unfavorable measuring conditions (e.g. fog) the instrument can be turned to a direction with the highest intensity of returning EDM signal.

- Align TC605/TC805/TC905/L
- Adjust the fine drives 1, 2 (in this example max. 28% are reached)
- Measure the distance.

Geodesical

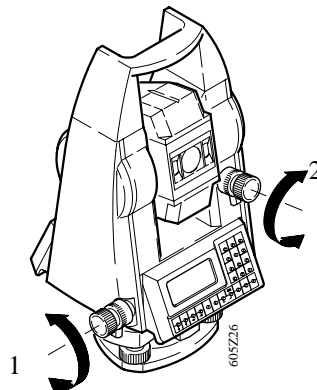

Configuration (CONFIG MENU)

Under "Configuration", specific settings can be carried out with the TC605/TC805/TC905/L unit so the instrument is optimally set to particular survey work.



Press (for about 2 seconds) until the configuration menu appears.

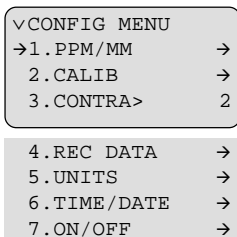

Scroll line by line.



Select menu item.



All settings remain active even after switch-off, except for the compensator **COMP**. This is reset to **ON** whenever the instrument is switched on again.

Meteorological correction (ppm)

The distance measurement is affected by the meteorological conditions. The distance can be corrected with appropriate **ppm** values. The ppm values for temperature and atmospheric pressure are obtainable from the diagram in *section "Technical data"*. Instead of the atmospheric pressure the mean height above sea level of the survey site may be used for interpolation. For example, 10°C (18°F) temperature difference makes a difference of 1mm in a measured distance of 100 m = 10 ppm.

√PPM/MM	
→ppm :	0
mm :	0

Enter value.



Confirm input and continue to enter the prism constant (mm).



Termination and back to CONFIG MENU.

Prism constant (MM)

The prism constant **MM** for Leica circular prisms is 0. It must be determined when using other types of prism. The prism constant must be always entered in units of (mm).

√PPM/MM	
ppm:	0
→mm :	0

Enter value.



Confirm input. The value is stored and also available after switching off the Total Station.

During a distance measurement the instrument displays both correction values (**PPM**) and (**MM**) for your information.

Manually set prism constants are automatically set to "0" when "RETTAP > ON" (under "MENU - EDM CONF").

The instrument automatically uses the Leica reflector tape constant ($c = 0.34$ mm) internally in this mode. When resetting to "RETTAP > OFF" the previously used prism constant for prisms is reactivated.

Display contrast (CONTRA)

```
◇ CONFIG MENU
1. PPM/MM      →
2. CALIB       →
→3. CONTRA>   3
```



By pressing several times the display contrast or reading angle can be changed.

- 0 : Optimal contrast if the display is above the eye level of the user (reading from below)
- 1,2 : Ideal for reading at eye level
- 3: Ideal for reading at eye level below the display.



Back to the normal measuring program.

 **Geodesical**

Data and recording parameter (REC DATA)

The **REC DATA** commands contain all relevant parameters and settings for data recording. Set these parameters as required and check the communication before starting recording for the first time.

```
◇ CONFIG MENU
  2 . CALIB          →
  3 . CONTRA>      3
→4 . REC DATA     →
```



```
√*4 . REC DATA
→1 . DATout>      MEM
  2 . FORMAT>      8
  3 . RS232 > MASK1
```

```
4 . BAUD >      9600
5 . PARITY>      EVEN
6 . ENDMRK>      CR / LF
```



Setting the desired parameters.

Possible settings:

DATOUT MEM, RS232
FORMAT 8, 16
RS232 MASK1, MASK2
BAUD 300 \ 600 \ 1200 \ 2400 \ 4800 \ 9600
PARITY EVEN \ ODD \ NONE
ENDMARK CR / LF \ CR



Confirm the input.

DATOUT

To record measurements, a data recorder can be connected to the serial data port (RS232 interface). The parameters of the serial interface are already set for standard Leica parameters (9600, EVEN, CR/LF). They remain stored after switching off the total station.

To use other data recorders (e.g. IBM-compatible PCs, Handheld computers, etc.) the interfacing parameters may need to be changed. The communication via the RS232 interface requires a certain protocol containing the exact command structure (for more information refer to the handbook "Leica Instruments online").



Do not turn the Total Station during measurements until data recording is finished. The current horizontal direction is always transmitted !

Internal data recording

The measured data (**OBSERV**) and the fixed-point coordinates (**COORDS**) are stored in the internal memory (refer to section "Data Management"). The internal memory can store information for a maximum of 3000 measurements or 4000 coordinate points. It is possible to store, for instance, 1500 field measurements and simultaneously 2000 coordinate points in the internal memory. New data are always appended to existing data.

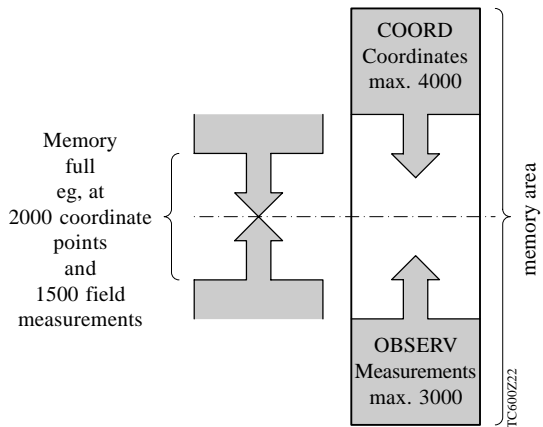
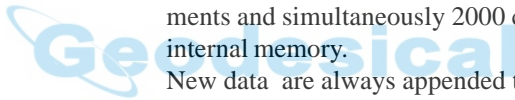

FORMAT The Leica GSI-format can be output as a 8 or 16 digit string. However, this format setting is only relevant for the serial output of data and has no effect on the entries into the instrument. This setting is only responsible for the output string size. As an example, if a 12-digit point number in the 8-character-mode is output only the last 8 digits are transferred. Internally, however, always 16-digit strings are used, in order to guarantee a later output in another data format.

Using an entry of a 12-digit point number or station designation as an example the format generated by the instrument is described below:

(The 12-digit entry is always possible in both cases).

Pt.No. input: 123456789012

Setting 8 characters (**FORMAT 8**) :

Display indication: 56789012

Output string: 110009+56789012 (Leica GSI format)

Setting 16 characters (**FORMAT 16**) :

Display indication: 123456789012

Output string: *110001+0000123456789012 (Leica GSI-Format)

Int. stored. 123456789012

RS232 Two data templates (= RECMASKS) are available for external recording:

MASK1 Pt Nr, Hz, V, slope distance, ppm/mm, hr, hi

MASK2 Pt Nr, Hz, V, slope distance, E, N, H, hr

Coordinate points are always stored in the format PtNr, E, N, H.



The settings of MASK1 and MASK2 have no affect to the data stored internally.

Selecting units (UNITS)

```
◇ CONFIG MENU
  3.CONTRA>    3
  4.REC DATA  →
  →5.UNITS    →
```

5

```
√*5.UNITS
→1.DIST >    m
  2.ANGLE >  360s
  3.V-ANGL>   V
4.ROUND >    high
```

Units

Parameters



Scrolling menu items with arrow keys.



Selecting option.



Confirm selection.

Geodesical

Units for distance measurement (DIST)

m = Meter

US ft = feet (decimal)

Units for angle measurement (ANGLE)

- gon = 400gon

- 360d = 359°.9999 (in decimals)

- 360s = 359° 59' 59" (sexagesimal)

V-Angle

V = zenith angle (zenith = 0)

$\pm V$ = vertical angle (horizontal = 0), rise (+), fall (-)

V% = slope: (horizontal = 0%), rise (+%), fall (-%)

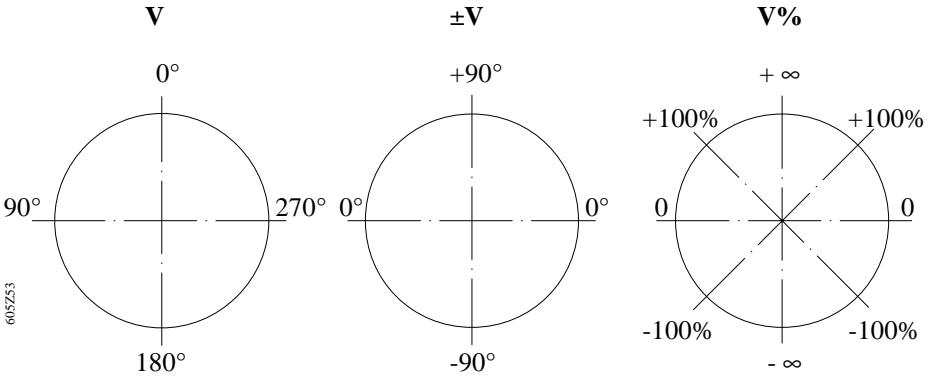

Geodesical

Rounding of displayed angles (ROUND)

high = 81°45'24" (1" Intervall)

med = 81°45'25" (5" Intervall)

low = 81°45'30" (10" Intervall)



The rounding of the displayed angles has no effect on the instrument's accuracy.

Setting time and date (TIME/DATE)

```
◇ CONFIG MENU
  4.REC DATA  →
  5.UNITS     →
  →6.TIME/DATE →
```

6

```
√*6.TIME/DATE
→1.SET TIME  →
  2.SET DATE  →
  3.SHW TIM/DAT →
```

1.SET TIME

1

```
*1.SET TIME
FORM      hh:mm:ss
TIME=    14:31:58
```

Geodesical



Change between input of hours, minutes and seconds.

Input of actual time via number block.



Confirm input and return to menu TIME/DATE.



Termination without saving.

2.SET DATE



* 2 . SET DATE

FORM dd/mm/yyyy
DATE= 18/02/1997



Move cursor to edit data.

Input of actual date via number block.



Confirm input and return to menu TIME/DATE.



Termination without saving.

3.SHW TIM/DAT



TIME - DATE

14:31:58
18/02/97



Exit display and return to menu TIME/DATE.



Exit the display and return to the normal measurement display.

Automatic switch-off (ON/OFF)

```

^CONFIG MENU
 5. UNITS      →
 6. TIME/DATE  →
 →7. ON/OFF    →
  
```



```

√*7. ON/OFF
 →1. BEEP >    ON
  2. BEP90° > OFF
  3. COMP >    ON
  
```

```

 4. HZcomp>    ON
 5. HZcoll>    ON
 6. AUToff>    ON
  
```



Scrolling menu items with arrow keys.



Selecting options.



Confirm settings and return to CONFIG MENU.



1.BEEP

After each key touch an acoustic signal indicates the successful data entry. The signal can be switched OFF but is active again after switching on the total station again (ON).

2.BEP90°

Setting-out of right angles:

To simplify setting-out of right angles an acoustic signal (BEEP) can be activated.

Set BEP90° to ON and confirm.

BEEP pulsating
+/- 4° (5gon)

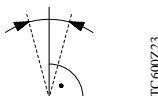

TC600Z23

BEEP continuous
+/- 30' (0.5gon)

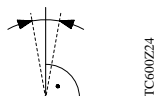

TC600Z24

no signal
+/- 30" (10mgon)

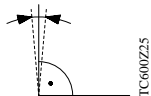

TC600Z25

3.COMP

The acoustic warning signal and the error message (Error **58 TILT**) can be suppressed if the total station is not required to be properly levelled up. (eg, on swaying platforms or ships).

For normal use set **COMP = ON**.

When switching the total station on the function is automatically set to **COMP = ON**.

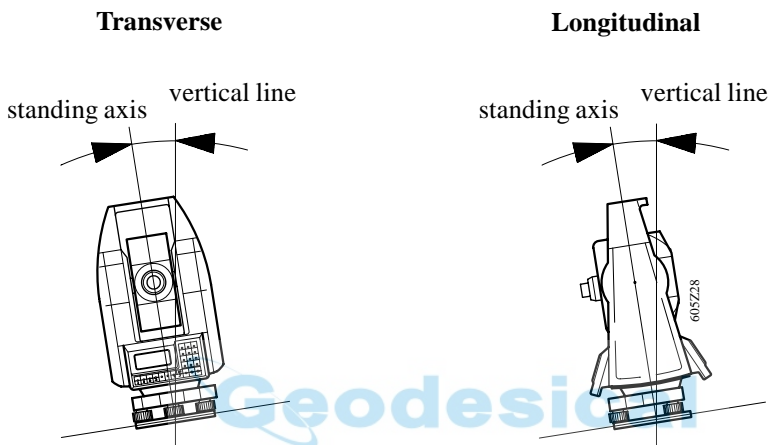

When the compensator is switched off (**COMP = OFF**) the vertical angle refers to the standing axis.

When the compensator is switched on (**COMP = ON**) the vertical angle refers to the vertical line (plumb line).

4.Hzcomp (dual axis compensation)

Function **HZCOMP = ON** corrects the Hz-angles for the tilt of the standing axis.

Switching the compensator (**COMP**) off also sets the function **HZCOMP** to **OFF**.

When switching the total station on the function is automatically set to **HZCOMP = ON**.

5.HZcoll

Corrects for the line-of-sight error:

If "HZcoll" is set to **ON** each measurement is corrected automatically for the line-of-sight error.

In case of setting **OFF** this correction is disabled.

6.AUToff

Automatic switch-off:

In case of longer breaks (> 10 minutes) the setting "AUToff = ON" switches the instrument automatically off to save battery capacity.

"AUToff = OFF" disables the automatic switch off and leaves the instrument permanently on until manually switched off with the -key.



The program TCTOOLS has the function of an external data manager for the TC605/TC805/TC905/L instruments.

This program runs under MS-DOS.

TCTOOLS provides for data exchange between a PC and the TC605/TC805/TC905/L and also includes a codelist manager to create and edit codelists.

The bidirectional data transfer and the conversion of the Leica GSI-format to ASCII and vice versa is supported by the individual functions.

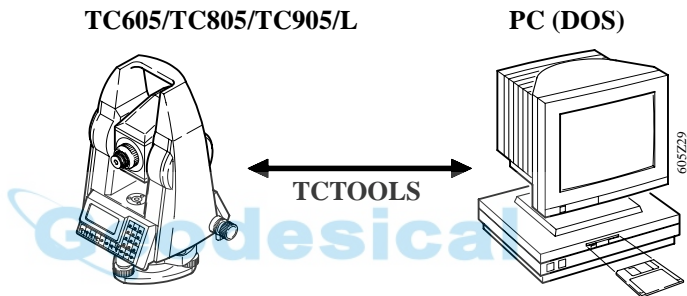

The program TCTOOLS consists of five main functions:

Codelist manager, Coordinate entry, Send data, Receive data, INFO/HELP

1. Codelist manager

With this function it is possible to create and edit code lists and to transfer code lists between the PC and the TC605/TC805/TC905/L fast and user-friendly.

The tabular input mask contains one CODE and five Info columns. Inputs are done likewise as in the Windows Excel program. Each code line must have a minimum of one entry in the code column else the complete code will not be accepted when saving the data.

Before a code is stored it must be packed, i.e. invalid and empty line will be eliminated.

Example

No	Code	Info1	Info2	Info3	Info4	Info5
1	101	PART1	CORN	CENTRE	1
2	102	CORN	BOTT	35
3	103	PART2	BOTT
...						
50	150	PART8	TOP

On the PC code lists can be created, edited, merged with each other and deleted. Transfer to the instrument is carried out via DATA TRANSFER, which also provides for receiving a codelist from the TC605/TC805/TC905/L and deletion of a codelist on the TC605/TC805/TC905/L.

- 2. Coordinate entry** The menu item **coordinate entry** offers the input for point number, Easting, Northing and Height.

3. Send data **Transfer coordinates from text-files to the TC and user specific format-files.**

Coordinates from text-files can be transferred using three different options.

1. ASCII files (Data in lines)

Sequential data structure with individual data elements separated by none numerical and none alphabetical characters. The complete data set contains one point number and the coordinates E (Easting), N (Northing) and H (Height), but at least data for E and N.

ASCII structure (data in lines):

```
PtNr      E          N          H
"100", "23456.678", "86543.456", "235.23"
-100*//23456.678*///-86543.456"" /235.2300
```

2. ASCII-Files (Data in columns)

Tabular data structure with individual data elements separated by spaces and none numerical and none alphabetical characters. One line must contain minimum values for E and N.

ASCII structure (data in columns):

PtNr	E	N	H
100	23456.678	86543.456	235.23
101	11025.025	45330.347	150.85

3. Leica GSI-Files

Extracts coordinates out of files in Leica format. These files can also contain measurements and coding information.

Only the point number and the related coordinates are extracted and transferred to the TC605/TC805/TC905/L.

4. Specific user formats

This option transfers user specific formats from the PC to the TC605/TC805/TC905/L. These specific formats are used to download data (please refer to chapter "Other data formats").

4. Receive data Data can be transferred either in Leica GSI-format or in a user specific format.

1. Leica GSI-formats

Measurements:

Mask1	:	WI11	Pointnumber	(P)
		WI21	Horizontal angle	(Hz)
		WI22	Vertical angle	(V)
		WI31	Slopedistance	(sld)
		WI51	PPM+MM	(ppm+mm)
		WI87	Reflector height	(hr)
		WI88	Instrument height	(hi)

Mask2	:	WI11	Pointnumber	(P)
		WI21	Horizontal angle	(Hz)
		WI22	Vertical angle	(V)
		WI31	Slopedistance	(sld)
		WI81	Target Easting	(E)
		WI82	Target Northing	(N)
		WI83	Target Height	(H)
		WI87	Reflector height	(hr)



Coordinates (COORDS):

WI11	Pointnumber	(P)
WI81	Target Easting	(E)
WI82	Target Northing	(N)
WI83	Target Height	(H)

Example of a GSI-format

```
11...+00000101 81...+23456678 82...+86543456 83...+00023523
11...+00000102 84...+23456678 85...+86543456 86...+00023523
11...+00000103 84...+23456678 85...+86543456 86...+00023523
```

2. User specific formats (Other formats)

For data transmission from TC605/TC805/TC905/L to the PC specially defined data formats can be used. These user specific output formats are created using specific software.

To download user specific formats, a format-file must be transferred to the TC605/TC805/TC905/L first. Once a user specific data format exists on the TC605/TC805/TC905/L, this format can be selected in TCTOOLS, which downloads the data from the data ranges COORDS, OBSERV in a specific defined format.

The user specific formats can be created as such, to suit the requirements for data processing best or to read the data out in a more readable format, such as a fieldbook format, etc.

For more information about other formats please refer to your nearest Leica representative.



INFO/HELP (On-line Help)

A complete On-line Help function is directly integrated into the TCTOOLS program and should be carefully read before using the TCTOOLS. All the possible functions of the program are described in detail by the Help texts of the TCTOOLS.

The file README.TXT on the diskette is supplied with each instrument.

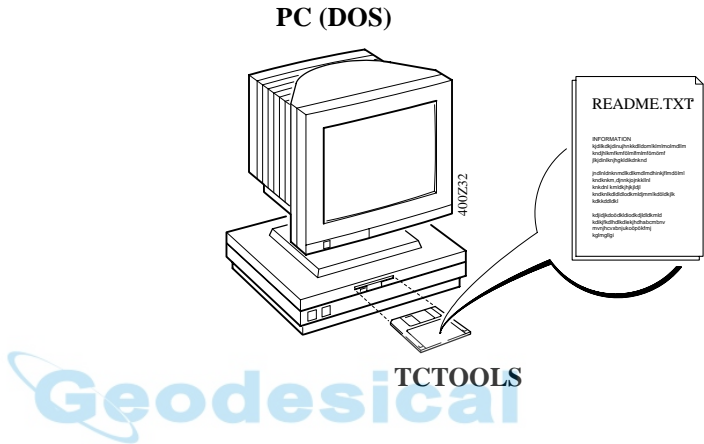

For data transfer the data cable (Part no. 563625) is needed. This cable is supplied with each instrument.

**TC605/TC805/
TC905/L**

TCTOOLS

PC (DOS)

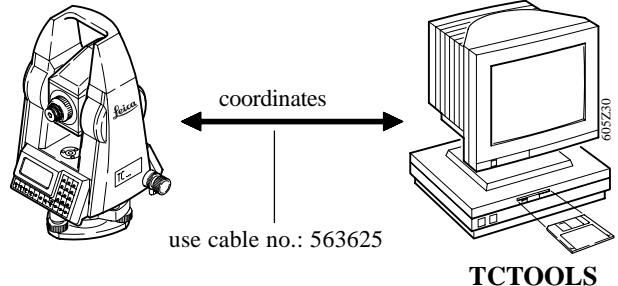

Other data formats

The instrument is designed to have flexibility in data output formats.

If you require specific data output formats, please consult your nearest Leica representative.



Communication TC605/TC805/TC905/L and PC/Datalogger

For more detail information of command and data structures refer to the handbook "Leica Instruments On-Line" which is available from your Leica representative.

Set a point number

Command structure:

(_ = space char.)

PUT/11....+12345678_CRLF

Set station coordinates

Station coordinates can be transmitted from an external data recorder via RS232 interface at any time without having to reset the instrument. However, the instrument must be in the highest level (measuring mode).

Command structure:

(_ = space char.)

Point number (PtNr) PUT/11....+12345678_CRLF
Easting (Eo) PUT/84...0+12345678_CRLF
Northing (No) PUT/85...0+12345678_CRLF
Height (Ho) PUT/86...0+12345678_CRLF
Instrument height (hi) PUT/88...0+12345678_CRLF

Set orientation

A new orientation direction can be transmitted at any time provided that the instrument is in the measuring display mode.

Command structure:

(_ = space char.)

Hz PUT/21...2+12345678_CRLF



Setting-out

Command structure
(- = space char.)

Call the function	'SETOUT' (setting-out)
Point number (PtNr)	PUT/11....+12345678_CRLF
Hz-angle to be set out:	PUT/24...2+12345678_CRLF
Horizontal distance to be set out:	PUT/34...0+12345678_CRLF
Height to be set out:	PUT/83...0+12345678_CRLF

Return to data transfer (**c** for a new point)
Terminates program function "setting-out" **x**

After the required 4 data lines are transmitted to the TC605/TC805/TC905/L unit, the display changes automatically to the mode showing the divergence between specified direction and present instrument direction.

After distance measurement (**DIST**) the difference between the computed and measured horizontal distance and the difference in height between the instrument position and the setting-out point are displayed. At the same time, the keys  and  are active to send data to an external data recorder. Measurements and data recordings can also be activated from an external data recorder.



This procedure to setout a point is similar to the on-board "setting out" program.

Checking and adjusting

Determine instrument errors (CALIB)

Press the -key (for about 2 seconds) until the configuration menu appears.

```
√CONFIG MENU
1 . PPM/MM      →
→2 . CALIB      →
3 . CONTRA>    3
```



```
√* 2 . CALIB
→1 . V-INDEX   →
2 . Hz-COLLIM  →
```



The measured angles are corrected with the opposite sign of the indicated instrument errors.

Vertical index error

The vertical circle should read exactly 90° (100 gon) when the line of sight is horizontal. Any deviation from this figure is termed vertical index error (i).

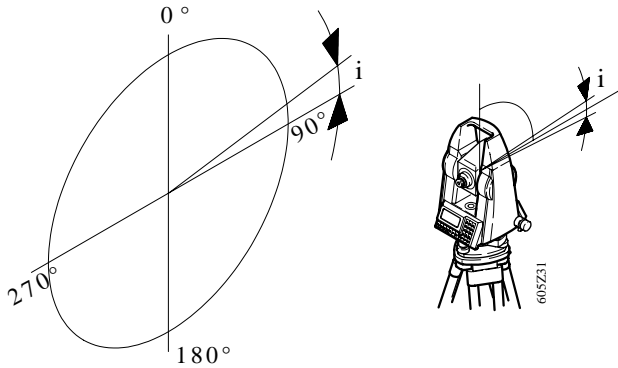

The stored vertical index error is displayed as an angular value in the units selected.

Procedure:



Before determining the vertical-index error use the electronic level to level up the instrument correctly. Select a point at a distance of about 100m which can be easily aimed and deviating no more than $\pm 5^\circ$ from the horizontal line.

1. step

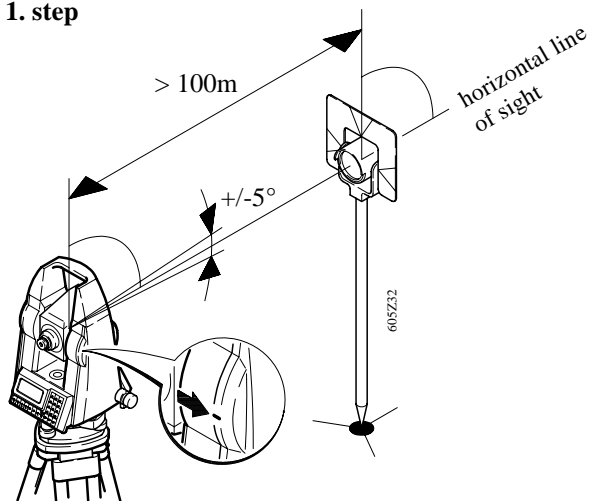

2. step

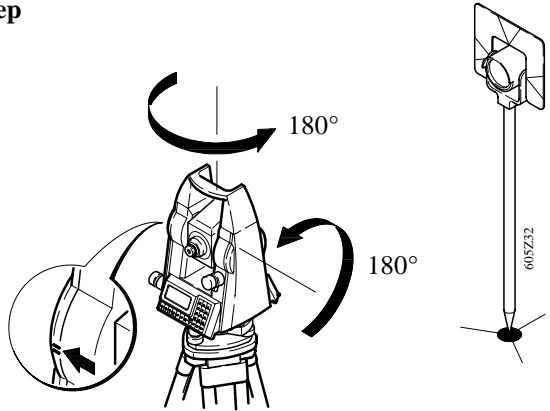

```
*1.V-INDE  
I : 0°00'00  
Inew : ----  
>Measure Index<
```

```
> Aim Point <
```

```
> Wait <
```

```
> Other Face <
```

```
> Wait <
```



Change face and aim point again.

```
*1.V-INDE  
I 0°00'00  
Inew -0°23'52  
> Set Value? <
```



Adopt the calculated value and return to the normal measuring mode.



Retain the old value and switch back to menu CALIB. By doing, so you can quit the menu at any time without saving the made corrections.



ERROR : 44
Value > 54'

Values greater than 54' (1 gon) are not permissible and the above error message is displayed.



Delete error message and return to the CALIB menu.



When you determine the vertical index error the electronic level is adjusted at the same time.

 **Geodesical**

Line-of-sight error (Hz-collimation)

The line-of-sight error or collimation error (C) is the deviation from the perpendicular of the tilting axis. It is determined and stored in a similar manner to the vertical-index.

At the factory and prior to delivery, the line-of-sight is adjusted. The residual line-of-sight error should be checked at regular intervals.

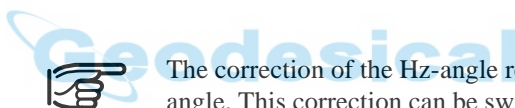
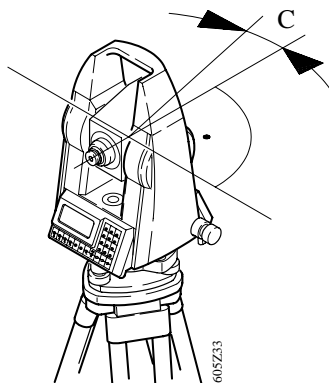

The correction of the Hz-angle relates to the vertical angle. This correction can be switched off.

```

◇ CONFIG MENU
 1 . PPM/MM      →
→2 . CALIB      →
 3 . CONTRA>    3
    
```



```

√*2 . CALIB
 1 . V-INDEX     →
→2 . Hz-COLLIM  →
    
```



```

*2 . Hz-COLLIM
C      0°00'00
Cnew :    ---
>Measure Collim<
    
```



```

> Aim Point <
> Other Face <
    
```

Change face and aim point again.



```
*2.Hz-COLLIM
C      0°00'00
Cnew  : 0°16'12
> Set Value? <
```



Adopt the calculated value and return to the normal measuring mode.



Retain the old value and return to the menu CALIB. By doing, so you can quit the menu at any time without saving the made corrections.



Index- and line-of-sight errors can change with time and temperature. They should, therefore be newly determined before the first use, before precision surveys, after long periods of transport, before and after long periods of work, and if the temperature changes by more than 10°C (18°F).

Tripod

The connections between metal and timber components must always be firm and tight.

- Tighten the Allen screws (2) moderately from time to time, as necessary.
- The same key is also suitable for adjusting the articulated joints on the tripod head (1). Tighten these just enough to keep the tripod legs open when you lift it off the ground.

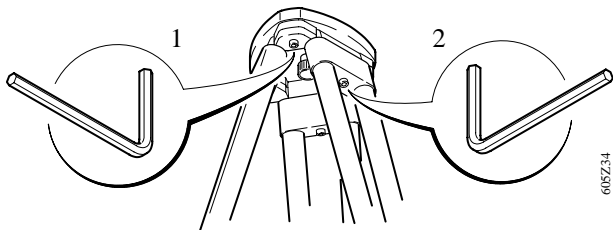

Circular level

Level-up the instrument in advance with the electronic level. The bubble must be centered. If it extends beyond the circle, use the allen key supplied to center it with the adjustment screws.

After adjustment no screw must be loose.

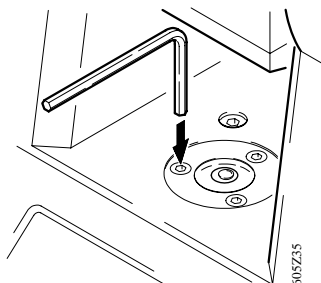

Circular level on the tribrach

Level the instrument and then remove it from the tribrach. If the bubble is not centred, adjust it using the adjusting pin in connection with the two cross-headed adjustment screws.

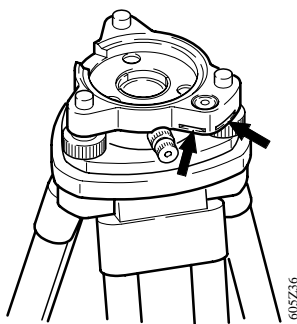

Turning the adjustment screws:

- to the left: the bubble approaches the screw
- to the right: the bubble goes in the other direction.

After adjustment no screw must be loose.

Optical plummet

Check the optical plummet of the tribrach at regular intervals. Any deviation of the line-of-sight from the vertical axis of the instrument causes a centering error.

Checking by plumb-bob:

Set up and level up the instrument (with plumb-bob) on the tripod. Mark the ground point. Remove the plumb-bob. Check that the crosshairs of the optical plummet intersect at the ground point. The accuracy achievable is about 1 mm.

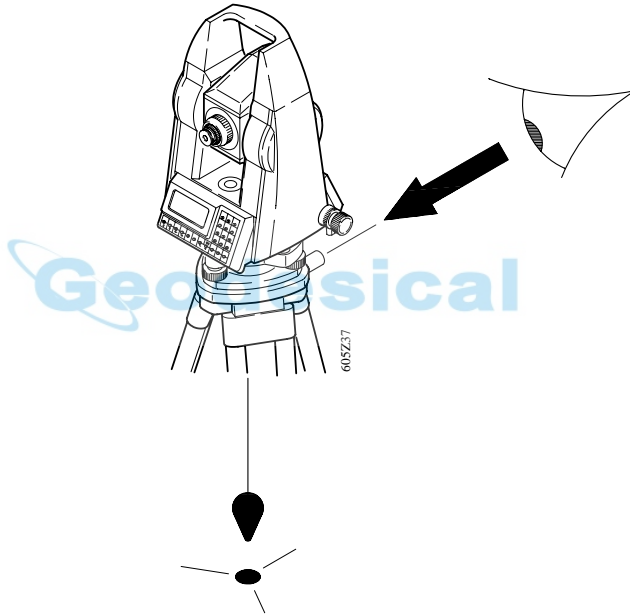

Checking by turning the tribrach:

1. Level up the instrument using the electronic level.
Mark the ground point. Using a pencil, mark the outline of the tribrach on the tripod plate.
2. Turn the tribrach 120° , fit it into the outline, level up the instrument, and again mark the ground point.
3. Repeat this procedure in the third position.

If the three points do not coincide, adjust the crosshairs of the tribrach to the center of the triangle formed by the three ground points.

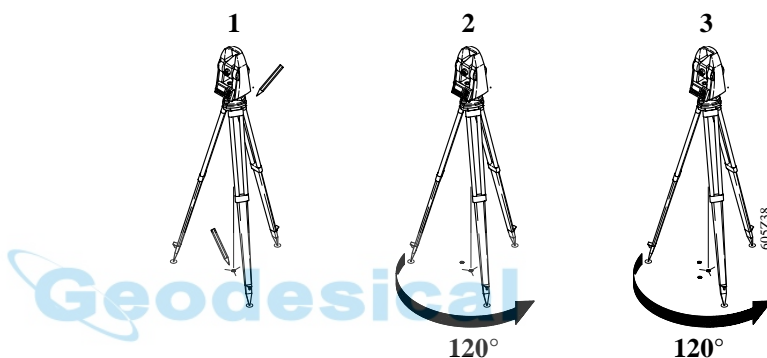

Adjustments:

Use a screwdriver to turn the two set screws alternately by the same small amount in order to center the crosshairs on the marked ground point.

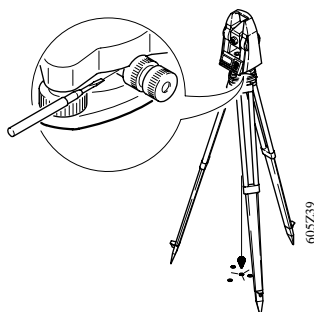

Laser plummet

The laser plummet is integrated into the vertical axis of the instrument. Under normal circumstances setting of the laser plummet is not necessary. If an adjustment is necessary due to external influences the instrument has to be returned to any Leica service department.

Checking by turning the instrument by 360°:

1. Install the instrument on the tripod and level up.
2. Switch on laser plummet and mark centre of the red point.
3. Turn instrument slowly by 360° and observe the red laser point.

If the centre of the laser point makes a clearly circular movement or if the centre of the point is moving away more than 1 mm from the first marked point an adjustment is possibly necessary. Call your next Leica service department.

Geodesical

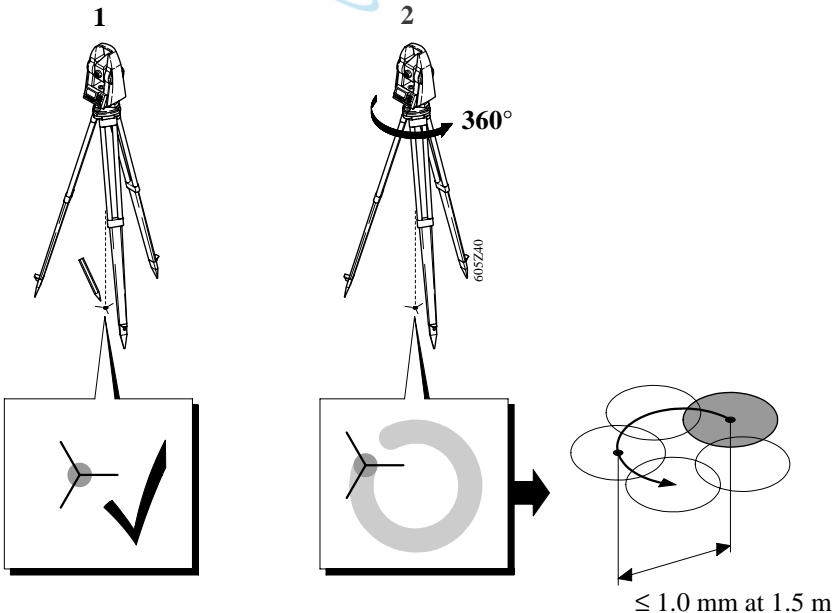

Depending on brightness and surface the size of the laser point can vary. At a distance of 1.5 m an average value of 2.5 mm diameter must be estimated.

The max. diameter of the circular movement of the centre of the laser point should not exceed 1 mm at a distance of 1.5 m.



Care and transport

Transport:

When dispatching the equipment, always use the complete original Leica packaging (case and cardboard box). When transporting the equipment in the field, always make sure to:

- either carry the instrument in its original transport case or
- carry the tripod with its legs splayed across your shoulder, keeping the **attached instrument upright**.

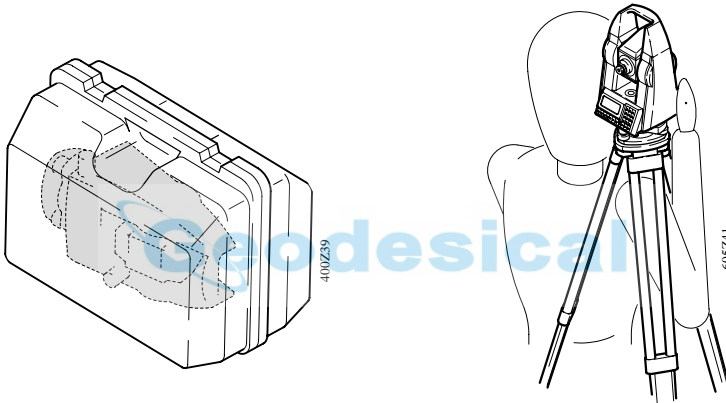

Cleaning and drying:

Objective, eyepiece and prisms

- blow dust off lenses and prisms
- Never touch the glass with fingers
- Use only a clean, soft and lint-free cloth for cleaning.
If necessary, moisten the cloth with pure alcohol.

Use no other liquids; these may attack polymer components.



When storing the equipment, particularly in summer and inside a vehicle, take the storage temperature limits (-40°C to + 70°C / -40°F to +158°F) into account.

Cables and plugs:

Keep plugs clean and dry. Blow out any dirt lodged in the plugs of the connecting cables.

If you unplug connecting cables during the measurement, you may lose data.

Always switch off the instrument before removing the connecting cables.

Fogging of prisms:

Reflector prisms that are cooler than the ambient temperature tend to fog. It is not enough to simply wipe them. Keep them for some time inside your jacket or in the vehicle to allow them to adjust to the ambient temperature.

Storage:



If the instrument becomes wet, leave it unpacked. Wipe down, clean, and dry the instrument (at not more than 40 °C/ 108°F), transport case, foam inserts, and accessories. Pack up the equipment only when it is perfectly dry.



After a longer period of storage or transport of your instrument always perform the field adjustments indicated in this manual before using the instrument.

Battery charging



WARNING:

Use a battery charger in a dry room only, never outdoors. Charge batteries only at an ambient temperature between 10°C and 30°C (50°F to 86°F). We recommend a temperature of 0°C to +20°C (32°F to 68°F) for storing the batteries.

Battery chargers GKL22 and GKL23

Charger GKL22:

The charger outputs constant current and charges a NiCd battery within 14 hours. The charging procedure starts automatically whenever a battery is connected to the charger and a red control lamp indicates a fully charged battery.

Charging batteries with 2 pole plug requires an adapter cable.

Fast charger GKL23:

Fast charging with the GLK-23 is possible with Leica NiCd-batteries equipped with a 5-pole plug. Fast charging requires 1.5 to 5 hours depending on the battery capacity.

Leica batteries with 2-pole plugs can be charged using an adapter cable - this charging procedure will take 14 hours.

Connecting 2 batteries at the same time, will charge the batteries sequentially. Batteries with fast charging capabilities are priority.

Charging modes and status of the GKL23 is shown by three color-LEDs.

For more information about use, functions and displays refer to the user manual of the GKL23.

Battery chargers **GKL12 and GKL14**

If you own one of these charging devices we recommend:

- to use the battery charger GKL12 for charging the battery insert (2-pole charging plug) of the total station and for charging the GEB70 compact battery.
- to use the battery charger GKL14 for charging the GEB71 universal battery.

Before you use new batteries for the first time, charge them for 20 to 24 hours. This also applies to batteries that have not been used for several months. NiCd batteries reach full capacity after two or three normal cycles each of a 14-hour charge followed by a full discharge

If battery performance drops noticeably, run one or two full cycles, i.e. charge for 14 hours and allow to discharge until the instrument displays 'Battery low'.

Leave flat batteries to charge for fourteen hours. If you do not know a battery's state of charge, also leave it to charge for fourteen hours.

Set the battery charger's voltage selector to your AC mains voltage, **115V** or **230V**. Plug in the charger to the mains. The green indicator lamp should light. If it does not light, there is a power cut or the mains cable or charger is faulty.

Connect the battery to the charger. The red charging indicator should light. If it does not, the battery is not charging, i.e. the battery cable is faulty or the battery fuse has blown and should be replaced. On the GKL12, you may not have started the timer or it may have stopped at the end of the charging period.

Safety directions

The following directions should enable the person responsible for the TC605/TC805/TC905/L, and the person who actually uses the instrument, to anticipate and avoid operational hazards.

The person responsible for the instrument must ensure that all users understand these directions and adhere to them.

Intended use of instrument

Permitted uses

The TC605/TC805/TC905/L electronic total stations are intended to the following applications:

- Measuring horizontal and vertical angles
- Measuring distances
- Recording measurements
- Computing by means of application software
- Visualising the aiming direction (with EGL1 Guide Light)
- Visualising the standing axis (with laser plummet)

Adverse uses

- Use of the total station without previous instruction
- Use outside of the intended limits
- Disabling safety systems and removal of hazard notices
- Opening the instrument using tools (screwdriver, etc.), unless this is specifically permitted for certain functions
- Modification or conversion of the instrument
- Use after misappropriation

- Use with accessories from other manufacturers without the prior express approval of Leica
- Aiming directly into the sun
- Inadequate safeguards at the measuring station (e.g. when measuring on roads, etc.)



WARNING:

Adverse use can lead to injury, malfunction, and damage.

It is the task of the person responsible for the instrument to inform the user about hazards and how to counteract them. The TC605/TC805/TC905/L total stations are not to be used until the user has been properly instructed how to use them.

Limits of use

Environment:

Suitable for use in an atmosphere appropriate for permanent human habitation; not suitable for use in aggressive or explosive environments. Use in rain is permissible for limited periods.

Refer to section "Technical data".

Area of responsibility for the manufacturer of the original equipment Leica Geosystems AG, CH-9435 Heerbrugg (hereinafter referred to as Leica):
Leica is responsible for supplying the product, including the user manual and original accessories, in a completely-safe condition.

Responsibilities of the manufacturers of non-Leica accessories:

The manufacturers of non-Leica accessories for the TC605/TC805/TC905/L electronic total station are responsible for developing, implementing and communicating safety concepts for their products, and are also responsible for the effectiveness of those safety concepts in combination with the Leica product.

Responsibilities of the person in charge of the instrument:



WARNING:

The person responsible for the instrument must ensure that it is used in accordance with the instructions. This person is also accountable for the training and deployment of personnel who use the instrument and for the safety of the equipment when in use.

The person in charge of the instrument has the following duties:

- To understand the safety instructions on the product and the instructions in the user manual.
- To be familiar with local regulations relating to accident prevention
- To inform Leica immediately if the equipment becomes unsafe.

Main hazards of use**WARNING:**

The absence of instruction, or the inadequate imparting of instruction, can lead to incorrect or adverse use, and can give rise to accidents with far-reaching human, material, financial and environmental consequences.

Precautions:

All users must follow the safety directions given by the manufacturer and the directions of the person responsible for the instrument.

**WARNING:**

The charger must not be used in damp or inclement conditions. If moisture penetrates the charger, the user may receive an electric shock.

Precautions:

Use the charger only indoors, in dry rooms. Protect it from damp. If the charger is damp, do not use it.

**WARNING:**

If you open the charger, either of the following actions may cause you to receive an electric shock:

- Touching live components
- Using the charger after incorrect attempts to carry out repairs

Precautions:

Do not open the charger yourself. Only a Leica-approved service technician is entitled to repair it.

**CAUTION:**

Watch out for erroneous distance measurements if the instrument is defective or if it has been dropped or has been misused or modified.

Precautions:

Periodically carry out test measurements and perform the field adjustments indicated in the user manual (*refer to section "Determine instrument errors" and "Checking and adjusting"*), particularly after the instrument has been subjected to abnormal use and before and after important measurements.

**DANGER:**

Because of the risk of electrocution, it is very dangerous to use reflector poles and extensions in the vicinity of electrical installations such as power cables or electrical railways.

Precautions:

Keep at a safe distance from electrical installations. If it is essential to work in this environment, first contact the safety authorities responsible for the electrical installations and follow their instructions.

**WARNING:**

By surveying during a thunderstorm you are at risk from lightning.

Precautions:

Do not carry out field surveys during thunderstorms.

**CAUTION:**

Be careful not to point the instrument directly towards the sun, because the telescope functions as a magnifying lens and can injure your eyes or damage the internal components of the EDM and EGL1 Guide Light.

Precautions:

Avoid pointing the telescope directly at the sun.

**WARNING:**

During target recognition or stakeout procedures there is a danger of accidents occurring if the user does not pay attention to the environmental conditions around or between the instrument and the target (e.g. obstacles, excavations or traffic).

Precautions:

The person responsible for the instrument must make all users fully aware of the existing dangers.

**WARNING:**

Inadequate securing of the surveying site can lead to dangerous situations, for example in traffic, on building sites and at industrial installations.

Precautions:

Always ensure that the survey site is adequately secured. Adhere to the regulations governing accident prevention and road traffic.

**CAUTION:**

If a target lamp accessory is used with the instrument the lamp's surface temperature may be extreme after a long working period. It may cause pain if touched. Replacing the halogen bulb before the lamp has been allowed to cool down may cause burning to the skin or fingers.

Precautions:

Use appropriate heat protection such as gloves or woollen cloth before touching the lamp, or allow the lamp to cool down first.

**WARNING:**

If computers intended for use indoors are used in the field, there is a danger of electric shock.

Precautions:

Adhere to the instructions given by the computer manufacturer with regard to field use in conjunction with Leica instruments.

**CAUTION:**

During the transport or disposal of charged batteries it is possible for inappropriate mechanical influences to constitute a fire hazard.

Precautions:

Before transporting or disposing of equipment, discharge the battery (e.g. by running the instrument in tracking mode until the batteries are exhausted or discharging with the GKL23 battery charger).

**CAUTION:**

If the accessories used with the instrument are not properly secured, and the equipment is subjected to mechanical shock (e.g. blows, falling etc.), the equipment may be damaged or people may sustain injury.

Precautions:

When setting-up the instrument, make sure that the accessories (e.g. tripod, tribrach, connecting cables, etc.) are correctly adapted, fitted, secured and locked in position.

Avoid subjecting the equipment to mechanical shock. Never position the instrument on the tripod baseplate without securely tightening the central fixing screw. If the screw is loosened always remove the instrument immediately from the tripod.

**WARNING:**

If the equipment is improperly disposed of, the following can happen:

- If polymer parts are burnt, poisonous gases are produced which may impair health.
- If batteries are damaged or are heated strongly, they can explode and cause poisoning, burning, corrosion or environmental contamination.
- By disposing of the equipment irresponsibly you may enable unauthorized persons to use it in contravention of the regulations, exposing themselves and third parties to the risk of severe injury and rendering the environment liable to contamination.
- Leakage of silicone oil from the compensator can damage the optical and electronic subassemblies.

Precautions:

Dispose of the equipment appropriately in accordance with the regulations in force in your country. Always prevent access to the equipment by unauthorized personnel.

Laser classification

Integrated distancer (EDM)

The EDM module built into the total station produces an invisible infrared beam which emerges from the telescope objective (*refer section "Technical data"*). The product is a Class 1 LED product in accordance with:

- IEC 825-1 : 1993 "Radiation safety of laser products".
- EN 60825-1 : 1994 "Radiation safety of laser products".

Class 1 LED products are safe under reasonably foreseeable conditions of operation and are not harmful to the eyes provided that the products are used and maintained in accordance with the instructions.

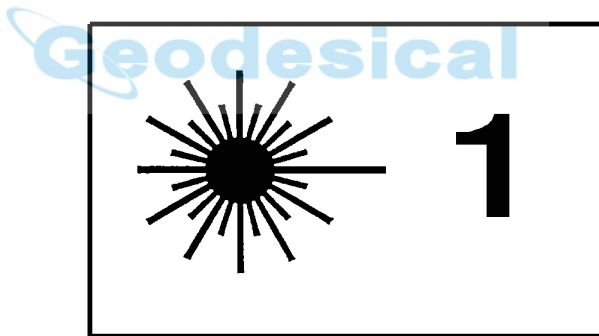

TC605/L

Beam divergence:	2.5 mrad
Impulse duration:	10 ns
Maximum power output:	200 μ W peak
Measurement uncertainty:	\pm 5%

TC805/TC905/L

Beam divergence:	2.02 mrad
Impulse duration:	10 ns
Maximum power output:	360 μ W peak
Measurement uncertainty:	\pm 5%

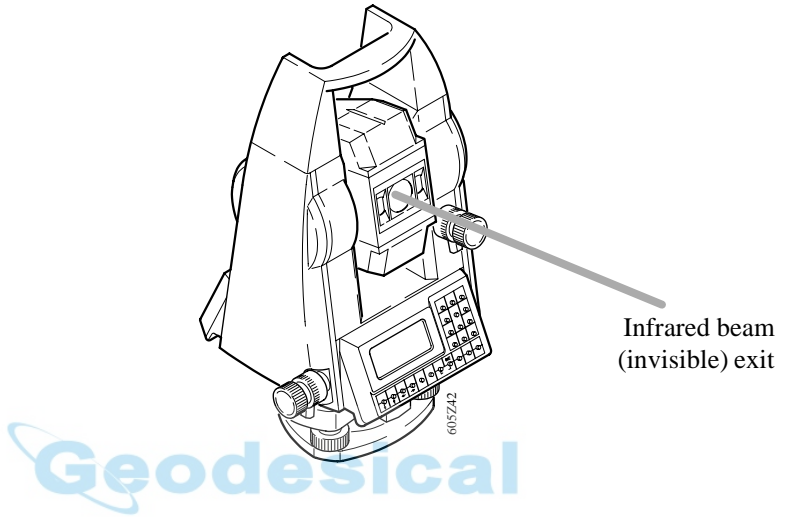

Guide Light EGL1
*(optional for TC805/
TC905/L series)*

The integrated Guide Light option produces an visible LED light beam from the upper front side of the telescope.

The product is a Class 1 LED product *) in accordance with:

- IEC 825-1 : 1993 "Radiation safety of laser products".
- EN 60825-1 : 1994 "Radiation safety of laser products".

*) within the specified working range > 5 m (> 16 ft).

Class 1 LED products are safe under reasonably foreseeable conditions of operation and are not harmful to the eyes provided that the products are used and maintained in accordance with the instructions.



CAUTION:

Use the Guide Light option within the specified range (at a distance of > 5 m (> 16 ft) from the telescope).

Geodesical

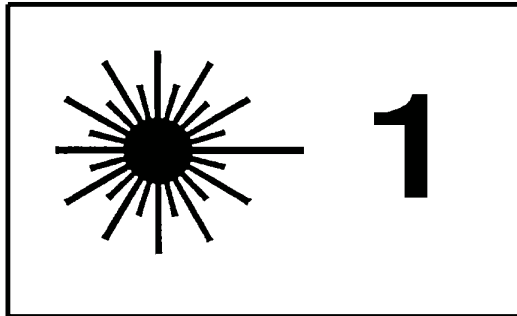

Flashing LED	Yellow	Red
Beam divergence	2.4 °	2.4 °
Impulse duration	2 x 35 ms	35 ms
Maximum power output	0.55 mW	1.2 mW
Measurement uncertainty	± 5 %	± 5 %

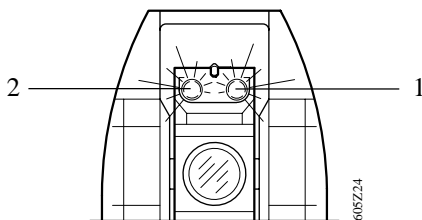

- 1 Exit for flashing red LED
2 Exit for flashing yellow LED

Geodetical

Laser plummet

The laser plummet built into the total station produces a visible laser beam which emerges from the bottom of the instrument. The product is a Class 2 laser product in accordance with:

- IEC 825-1 : 1993 "Radiation safety of laser products".
- EN 60825-1 : 1994 "Radiation safety of laser products".

The product is a Class II laser product in accordance with:

- FDA 21CFR Ch.I §1040: 1988 (US Department of Health and Human Service, Code of Federal Regulations)

Class 2/II laser products: Do not stare into the beam or direct it unnecessarily at other persons. Eye protection is normally afforded by aversion responses including the blink reflex.



WARNING:

It can be dangerous to look into the beam with optical equipment (e.g. binoculars, telescopes)

Precautions:

Do not look directly into the beam with optical equipment.

**Labelling in accordance
with IEC825-1,
EN60825-1**

Max. emitted Power :	0.95mW c.w.
Emitted Wavelength :	620-690nm
Standard applied :	EN60825-1:1994-07 IEC825-1 : 1993-11

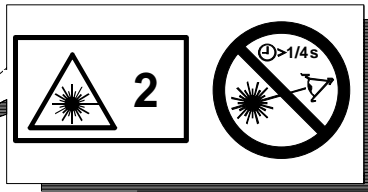
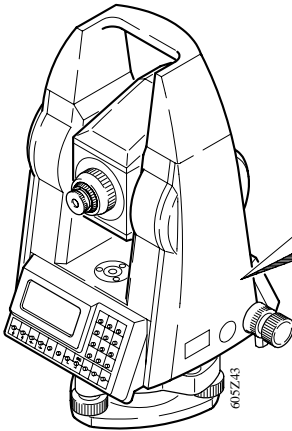

Geotechnical

Type: TC.....	Art.No.:
Power: 12V= nominal 400mA max.	
Leica AG, CH-9435 Heerbrugg	CE
Made in Switzerland	
Manufactured:1997	S.No.:

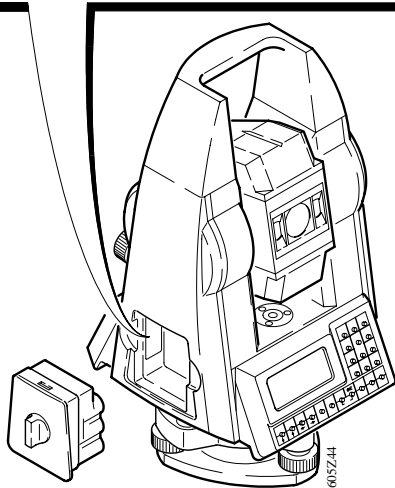

Labelling in accordance
with FDA 21CFR

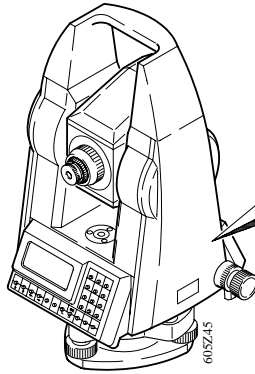

Type: TC..... Art.No.:
Power: 12V=nominal, 400mA max.
This laser product complies with
21 CFR 1040 as applicable
Leica AG, CH-9435 Heerbrugg
Made in Switzerland
Manufactured:1997 S.No.:

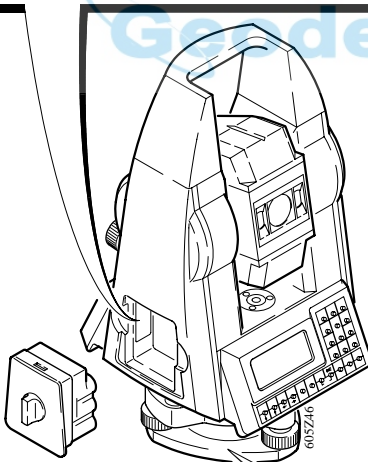

AVOID EXPOSURE
Laser radiation is emitted
from this aperture

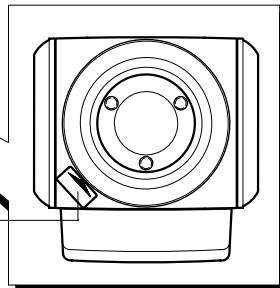

	in accordance with: IEC825-1: 1993 EN60825-1: 1994	in accordance with: FDA 21CFR Ch.I §1040: 1988
Beam divergence: Impulse duration: Maximum power output: Measurement uncertainty:	0.16 x 0.6 mrad c.w. 0.95 mW ± 5%	0.16 x 0.6 mrad c.w. 0.95 mW ± 5%

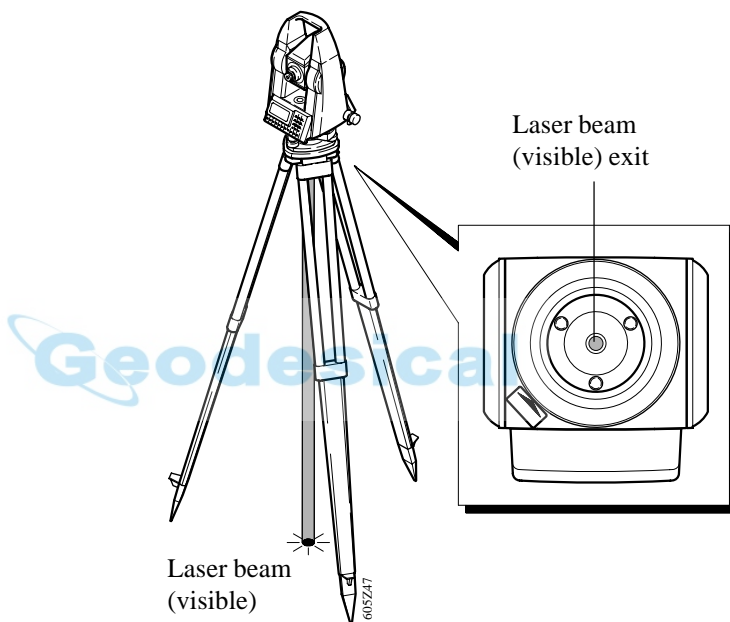

CAUTION:

Allow only authorized Leica service workshops to service the total station.

Electromagnetic acceptability

The term "electromagnetic acceptability" is taken to mean the capability of the instrument to function correctly in an environment where electromagnetic radiation and electrostatic discharges are present, and without causing electromagnetic disturbances in other equipment.



WARNING:

Electromagnetic radiation can cause disturbances in other equipment.

Although the total station meets the strict regulations and standards which are in force in this respect, Leica cannot completely exclude the possibility that other equipment may be disturbed.



CAUTION:

There is a risk that disturbances may be caused in other equipment if the total station is used in conjunction with accessories from other manufacturers (e.g. field computers, personal computers, portable radios, non-standard cables, external batteries etc.).

Precautions:

Use the equipment only with accessories from Leica. When combined with total stations, the strict requirements stipulated by the guidelines and standards are assured. When using computers and portable radios, pay attention to the information provided by the manufacturer., regarding electromagnetic acceptability.

**CAUTION:**

Disturbances caused by electromagnetic radiation can result in the tolerance limits for measurements being exceeded.

Although the total station meets the strict regulations and standards which are in force in this connection. Leica cannot completely exclude the possibility that the total station may be disturbed by very intense electromagnetic radiation, for instance near radio transmitters, portable radios, diesel generators etc.

Precautions:

Check the plausibility of results obtained under these conditions.

**WARNING:**

If the total station is operated with cables attached at only one of their two ends (e.g. external power supply cables, interface cables, etc.), the permitted level of electromagnetic radiation may be exceeded and the correct functioning of other instruments may be impaired.

Precautions:

While the total station is in use, cables (e.g. instrument to external battery, instrument to computer, etc.) must be connected at both ends.

***FCC statement
(applicable in U.S.)***

**WARNING:**

This equipment has been tested and found to comply with the limits for a Class B digital device, pursuant to part 15 of the FCC rules.

These limits are designed to provide reasonable protection against harmful interference in a residential installation.

This equipment generates, uses and can radiate frequency energy and, if not installed and used in accordance with the instructions, may cause harmful interference to radio communications. However, there is no guarantee that interference will not occur in a particular installation. If this equipment does cause harmful interference to radio or television reception, which can be determined by turning the equipment off and on, the user is encouraged to try to correct the interference by one or more of the following measures:

- Reorient or relocate the receiving antenna.
- Increase the separation between the equipment and the receiver.
- Connect the equipment into an outlet on a circuit different from that to which the receiver is connected.
- Consult the dealer or an experienced radio/TV technician for help.



WARNING:

Changes or modifications not expressly approved by Leica for compliance could void the user's authority to operate the equipment.

Geodesical

Product labeling

This device complies with part 15 of the FCC Rules. Operation is subject to the following two conditions:
(1) This device may not cause harmful interference, and
(2) this device must accept any interference received, including interference that may cause undesired operation.

*This device complies with part 15 of the FCC Rules. Operation is subject to the following two conditions:
(1) This device may not cause harmful interference, and (2) this device must accept any interference received, including interference that may cause undesired operation.*

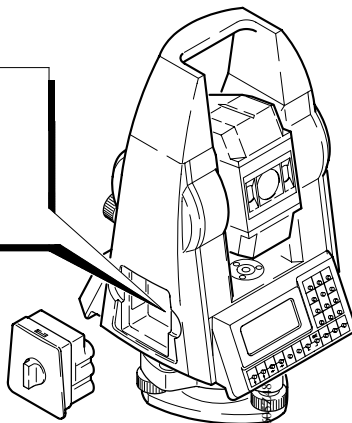

Error reports and warnings

	Error report	Cause	Remedy
02	Full	Internal memory is full	Clear internal memory
03	Invalid Value	Non-valid value was entered	Enter a valid value
12	Battery Empty	Battery exhausted	Change battery
19	Temperature	The inside of the instrument is too hot or too cold	Cool or warm the instrument
21	Parity Error	Parity error at interface	Inspect cables and interface parameters
22	RS232 Timeout	The system is receiving no response from the interface	Inspect cables, and functionality of external recording device. Inspect baud rate
24	RS232 Overflow	The data are being transmitted too quickly	Repeat using a lower baud rate
44	Value >1 gon	V-index measured, or line-of-sight error, is > 54' (> 1 gon)	Redetermine value, or contact service department
50	Angle Error	Measuring error angle scanning	Contact service department
51	System error	System error in compensator	If fault re-occurs, contact service department
55	EDM Signal	EDM signal faint, absent or distorted	Inspect pointing. Check that distance is not too great

	Error report	Cause	Remedy
56	EDM System	System error in EDM	If error occurs repeatedly, contact service department
58	TILT	Total station not levelled	Level the instrument or re-adjust the V-index, which adjusts also the electronic level
	Invalid Data	Invalid data for transfer to TC605/TC805/TC905/L	Press  key
82	Out of Range	For determination of index- or collimation error, V-angle is more than $\pm 6^\circ$ (6.6666 gon) off the horizontal plane	Bring target point within tolerance range
9x		System defective	Contact service department

	Warning	Cause	Remedy
09	PtNr Overflow	PtNr outside the upper and lower limits	Enter a new PtNr max. 8 digits
10	PtNr.Not Incr.	PtNr. cannot be incremented	Change PtNr. manually
12	Battery Low	The battery is practically flat (Level=0)	Change battery or connect an external battery

Technical data

Distance measurement

RANGE [m] (ft)	TC605/L	TC805/L	TC905/L
Atmospheric conditions	1 prism/ 3 prisms	1 prism/ 3 prisms	1 prism/ 3 prisms
poor 1)	800 (2600) / 1000 (3300)	1200 (3900) / 1500 (4900)	1200 (3900) / 1500 (4900)
fair 2)	1100 (3600) / 1600 (5200)	2500 (8200) / 3500 (11500)	2500 (8200) / 3500 (11500)
excellent 3)	1300 (4300) / 2000 (6500)	3500 (11500) / 5000 (16400)	3500 (11500) / 5000 (16400)

- 1) very hazy, visibility 3 km, or strong sunlight and heavy heat shimmer
 2) light haze, or some clouds and slight heat shimmer
 3) overcast, no haze, visibility 30 km, no heat shimmer

Geodesical

Standard deviation	TC605/L	TC805/L	TC905/L
Fine mode	3mm + 3ppm	2mm + 2ppm	2mm + 2ppm
Rapid mode	- - -	3mm + 2ppm	3mm + 2ppm
Tracking	10mm + 3ppm	5mm + 2ppm	5mm + 2ppm

Measurement time [sec]	TC605/L	TC805/L	TC905/L
Fine mode	4	2.5	2.5
Rapid mode	- - -	0.9	0.9
Tracking	0.5	0.3	0.3

Angle measurement

	TC605/L	TC805/L	TC905/L
Standard deviation ["] (mgon)	5 (1.5)	3 (1)	2 (0.6)
Display resolution ["] (mgon)	10", 5", 1" (2, 1, 0.2)	10", 5", 1" (2, 1, 0.2)	10", 5", 1" (1, 0.5, 0.1)

- absolute, continuous, updates each 0.3 sec
- Units selectable:
400 gon; 360° decimal; 360° sexagesimal;
V%, ±V, V

Telescope

	TC605/L	TC805/L	TC905/L
Objectiv lens-Ø [mm] (in)	28 (1.1)	42 (1.7)	42 (1.7)
Shortest focusing distance [m] (ft)	2 (6.5)	1.7 (5.6)	1.7 (5.6)
Field of view	1°30' (26 m/km)	1°30' (26 m/km)	1°30' (26 m/km)
Magnification	28x	30x	30x

- Topics**
- Level sensitivity : Circular level: 4/2mm
Electronic level: 5" (1.5 mgon)
- Optical plummet: In tribrach, focusable,
Magnification 2x
Accuracy: 0.5mm/1.5m
- Laser plummet : In alidade, turn with instrument
Accuracy: max. diameter of the
circular movement of the centre of the
laser point: ≤ 1.0mm/1.5m
PointØ of laser point: 2.5mm/1.5m
- Compensator : liquid, dual axis
Working range: ±5' (±0.1 gon)
Accuracy: ±2" (±0.6 mgon)
- Display : Liquid crystal
4 lines of 16 characters
- Keyboard : TC605/L: 1 Keyboard,
alphanumerical
TC805/TC905/L: 2 Keyboards,
alphanumerical
- EGL1 (optional): working range: 150m (500 ft)
divergence: 12m (40ft) at 100m (330ft)

	Automatic corrections	: • Hz-collimation • vertical index • earth curvature and refraction • standing axis tilt
Features	Built-in programs	: • Station set, Orientation set • Free station • Set out • Tie distance • Calculate Area • Rapid measurement • Reference line
Special	Quick-Code	: The first 10 lines in the codelist are assigned to the numeric keys (1, 2, ..., 9, 0). 1 keystroke measures and records including codes!
	Data manager	: powerful data management system "Input, find, view, delete points or complete data ranges"
Data memory	Internal storage	: 3000 data sets for measurements or 4000 points with coordinates
	External interface	: RS232
Dimensions	Height, length, width	: TC605/L: 344 x 175 x 194 mm TC805/L: 344 x 204 x 194 mm TC905/L: 344 x 204 x 194 mm
	Instrument weight (incl. battery)	: TC605/L: 4.3 kg (9.5 lbs) TC805/L: 5.6 kg (12.3 lbs) TC905/L: 5.6 kg (12.3 lbs)
	Tribrach weight	: GDF11: 0.6 kg (1.3 lbs) GDF12: 0.7 kg (1.5 lbs) GDF21: 0.77 kg (1.7 lbs) GDF22: 0.85 kg (1.9 lbs)

Power supply

Operating life of batteries	GEB77 battery module	GEB70 compact battery	GEB71 universal battery
Voltage / capacity	12V / 0.6A	12V / 2.0A	12V / 7.0A
No. of measurements with distance	approx.	approx.	approx.
TC605/L	700	1400	5000
TC805/TC905/L	800	2000	7000
Operating time [h] (EDM mode FINE)			
- angle meas. only	10	30	80
- angle and distance	5	12	48
Recharging time [h]	1	1.5	5
Weight [kg]	0.2	0.9	3.0

Temperature range Operation : -20°C(-4°F) to +50°C(122°F)
 Storage : -40°C(-40°F) to +70°C(158°F)



Atmospheric correction in ppm with °C, mb, H (meter)
at 60% relative humidity

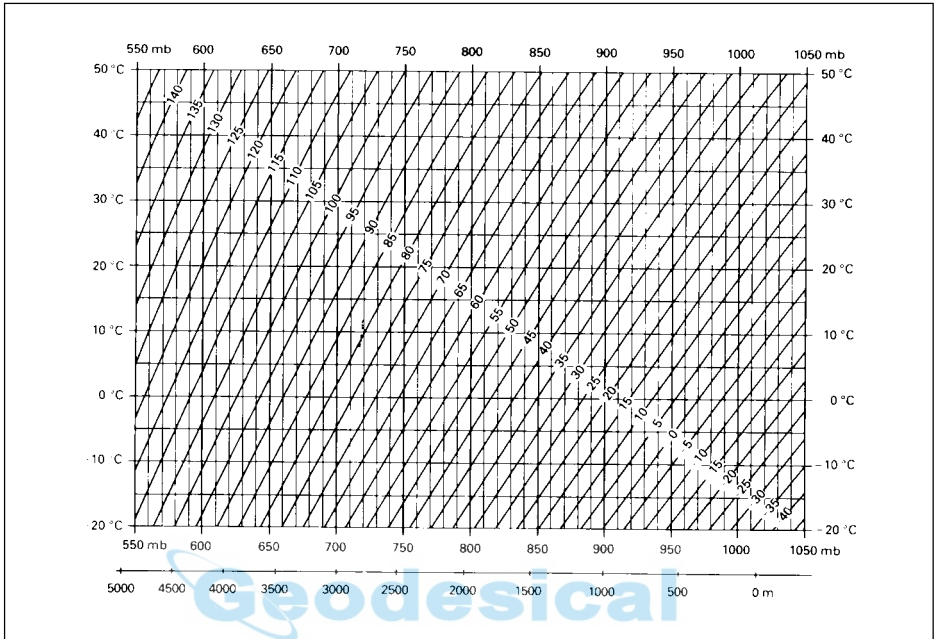

Atmospheric correction in ppm with °F, inch Hg, H (Feet)
 at 60% relative humidity

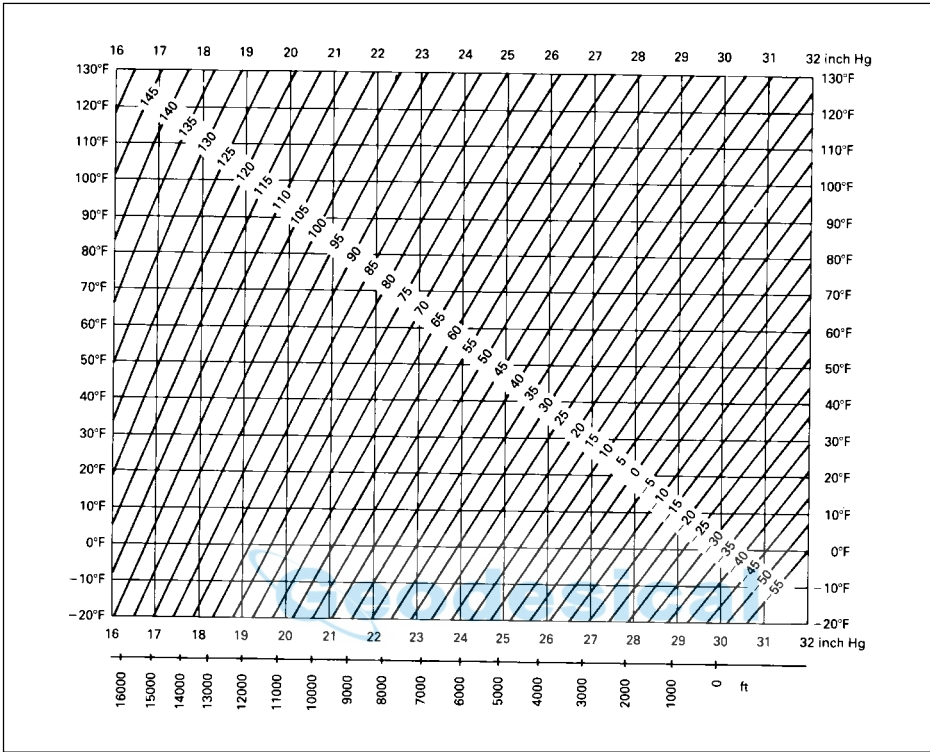

Index

A	AC mains voltage	127
	Additional entries	36
	Adjusting	113
	Adverse uses	128
	Alphanumeric entry	22
	ANGLE	97
	Angle measurement	150
	Area computation	57
	ASCII	104, 105
	Atmospheric correction	153, 154
	Atmospheric distance correction	27
	Automatic corrections	151
	Azimuth	54
<hr/>		
B	Battery	88
	Battery chargers	126, 127
	Battery charging	126
	Battery status	88
	BEEP	101
	BEP90°	101
	Boundary line	62
<hr/>		
C	Cables	125
	Calc Area	57
	Charger	126
	Charging	13
	Circular level	119
	Cleaning	124
	Code input	77
	Codelist	104
	Codes	76
	Coding	31
	Command structure	112
	Communication	111
	COMP	102
	Compensator	150
	Configuration	90
	Contrast	93
Control keys	19, 21	

Coordinate entry	76
Coordinates	105
Cursor	23

D	Data and recording parameter	94
	Data management	75
	Data manager	151
	Data transfer	104
	DATOUT	94
	Delete	82, 83
	Determine instrument errors	113
	Dimensions	151
	Display	19, 150
	Display contrast	93
	Display of recorded data	30
	Display of stored data	81
	Display symbols	27
	DIST	97
	Distance corrections	91
	Distance measurement	28, 149
	DSP	74

Geodesical

E	EDM	84, 136
	EDM mode	84
	EDM Signal	89
	EGL1	150
	Electromagnetic acceptability	144
	Electronic level	17, 114
	Entering point number	70
	Error reports	147
	External batteries	13

F	Fast charger	126
	FIND	78
	Fixed keys	20
	Fogging of prisms	125
	FORMAT	96
	Free Station	47
	Function keys	20

<hr/>		
G	GSI-forma	104
	Guide Light	85, 138
<hr/>		
H	Hazards of use	131
	Height difference	27, 54
	Height offset	53
	Horizontal angle	27
	Horizontal circle	72
	Horizontal distance	27
	Hz	72, 73
	Hz-collimation	117
	Hzcol	103
	Hzcomp	102
<hr/>		
I	Indication	50
	INPUT	76
	Input keys	19, 21
	Input of coordinates	76
	Instrument parameters	88
	Intended use of instrument	128
	Internal battery	13
	Internal memory	43, 95
	Internal storage	151
	IntMem	43, 45, 55
	Introduction	8
	<hr/>	
K	Keyb	45, 53, 55
	Keyboard	19, 150
	Keypad	19
<hr/>		
L	Laser classification	136
	Laser plummet	16, 122, 140, 150
	Leica GSI masks	107
	Leica Instruments On-Line	111
	Level sensitivity	150
	Levelling-up	17
	Limits of use	129
	Line-of-sight error	117

<hr/>		
M	Manual point entry	42
	MASK	96
	Measure and record	27, 31
	Menu tree (configuration)	25
	Menu tree (main menu)	24
	Menu tree (programs)	26
	Meteorological correction	91
MM	92	
<hr/>		
N	Numeric entry	22
<hr/>		
O	Offset	66
	Offset or hidden points	29
	OnLine	55
	Operating concept	18
	Optical plummet	120, 150
	ORIENTATION	45
	Orientation	41
	Orientation correction	50
Orientation of horizontal circle	45	
<hr/>		
P	Permitted uses	128
	Point number	27
	Power supply	152
	ppm values	91
	Prism constant	27, 92
<hr/>		
Q	Quick-Code	33, 151

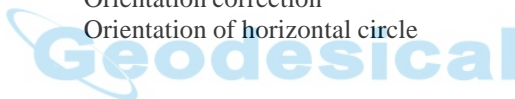

R	Rapid measurement	60
	RECMASK	96
	Recording	95
	Recording codes	37
	Reference Line	62
	Reflector height	23, 27
	Relative humidity	153, 154
	Responsibilities	130
	Retro tapes	87
	RETTAP	86
	ROUND	98
	RS232	96
	RS232 interface	31, 94

S	Safety directions	128
	Searching	78
	Set Station	41
	Set station coordinates	41
	Set station coordinates by PC	111
	Set-up	14
	Setout	52
	Setting out	52, 67
	Setting the display mask	74
	Setting-out by PC	112
	Setting-out of right angles	101
	Settings	70
	Slope distance	27
	Storage	125
	Switch-off	101

T	Target points	49
	TCTOOLS	104
	Technical data	149
	Telescope	150
	Temperature limits	125
	Temperature range	152
	Tie Distance	54
	Tracking mode	30, 60
	Transport	124
	Tribrach	119
	Tripod	118

U	UNITS	97
	Units for angle measurement	97
	Units for distance measurement	97
	Unpacking	12
	Up- and Download	107
User Programs	39	

V	V-Angle	98
	Vertical angle	27, 98
	Vertical index error	114
	VIEW	81

W	Wildcards	38, 79
----------	-----------	--------

Z	Zenith angle	98
----------	--------------	----



***Leica Geosystems AG,
Heerbrugg, Switzerland
has been certified as being
equipped with a quality
system which meets the
International Standard of
Quality Management
and Quality Systems
(ISO standard 9001)***



***Total Quality Management-
Our commitment to total
customer satisfaction***

Geodesical

***Ask your local Leica agent for
more information about our
TQM program***

The word "Geodesical" is written in a light blue, sans-serif font. A light blue ring, resembling a planet's orbit, encircles the letter "G".

Leica

*Leica Geosystems AG
Geodesy
CH-9435 Heerbrugg
(Switzerland)*

Phone +41 71 727 31 31

Fax +41 71 727 46 73

www.leica.com

664958-1.1.1

Printed in Switzerland - Copyright Leica Geosystems AG,
Heerbrugg, Switzerland 1998
Original text