

Geodimeter® System 600 and 600 Pro



User Manual

10:th Edition Publ.Nr. 571 701 121

RADIO FREQUENCY INTERFERENCE

This equipment generates and uses radio frequency energy but may not cause interference to radio and television reception. It has been type tested and found to comply with the limits for a Class B digital device in accordance with the specification in Subpart J of Part 15 FCC Rules and the EMC directive as stated in 89/336/EEC, which are designed to provide reasonable protection against such interference in a residential installation. However, there is no guarantee that interference will not occur in a particular installation. If this equipment does cause interference to radio or television reception, which can be determined by switching the equipment off and on, the user is encouraged to try to correct the interference by one or more of the following measures.

- reorient the receiving antenna
- relocate the instrument with respect to the receiver
- move the instrument away from the receiver

If necessary, the user should consult the dealer or an experienced radio/television technician for additional suggestions. The user may find the following booklet prepared by the Federal Communications Commissions helpful: 'How To Identify And Resolve Radio-TV Interference Problems'.

This booklet is available from the US Government Printing Office, Washington, DC 20402, Stock No. 004-000-00345-4.



CLASS 1 LED PRODUCT

This equipment complies with the regulations for a Class 1 LED product.

CAUTION – Use of controls or adjustments or performance of procedures other than those specified herein may result in hazardous LED radiation exposure

Modifications resulting from technical developments may be in the interest of our customers. Illustrations and specifications are therefore not binding, and are subject to change without prior notice.

TRADEMARKS

® Geodimeter, Geodat, Geotracer and Tracklight are registered trademarks and Autolock™ is trademark of Spectra Precision AB.

COPYRIGHT

© by Geotronics AB, 1996, 1997, 1998. All rights reserved. No part of this publication may be reproduced, transmitted, transcribed, stored in a retrieval system, or translated in to any language in any form by any means without the written permission of Spectra Precision AB / Geodimeter.

10:th EDITION

Printed in Sweden 03.98 Publ.No. 571 701 121, Larserics DIGITAL PRINT AB.

Table of Contents

Index	A
Welcome to Geodimeter System 600/600 Pro	B
About the manual	C
How to use this Manual	D
Glossary	F

Part 1 - Operating Instructions

Chapter 1 - Introduction	
Unpacking & Inspection	1.1.3
Controls	1.1.5
The Side Cover	1.1.6
The Central Unit	1.1.7
The Control Unit	1.1.9
LED Information	1.1.26
Chapter 2 - Pre-Measurement	
Office Setup	1.2.2
Pre-Settings	1.2.5
Special Settings	1.2.12
Test Measurements	1.2.20
Chapter 3 - Station Establishment	
Start Procedure	1.3.2
Station Establishment - P20	1.3.11
Chapter 4 - Carrying Out A Measurement	
Distance & Angle Measurement	1.4.2
Chapter 5 - Surveying methods	
In general	1.5.2
Conventional Surveying with Autolock™ (only servo)	1.5.4

Remote Surveying _____	1.5.7
Robotic Surveying (only servo) _____	1.5.12
Eccentric Point _____	1.5.21
The RPU Menu _____	1.5.23

Chapter 6 - Important Pages _____

ASCII Table _____	1.6.2
General measuring hints _____	1.6.4
Info Codes _____	1.6.9

Part 2 - Technical Description "The Yellow Pages"

Chapter 1 - Angle Measurement System _____

Overview _____	2.1.3
The Angle Measurement Technique _____	2.1.3
Two-Face Angle Measurement _____	2.1.6
Summary of Advantages in Angle Measurement _____	2.1.7

Chapter 2 - Distance Measurement System _____

Overview _____	2.2.3
Distance Measurement _____	2.2.3
Remote Object Elevation (R.O.E) _____	2.2.10
UTM Scale Factor Corrected Distances _____	2.2.13

Chapter 3 - Tracklight® _____

Overview _____	2.3.3
How to Activate Tracklight _____	2.3.4
Changing the Bulb _____	2.3.5

Chapter 4 - Servo _____

Overview _____	2.4.2
Servo Controls _____	2.4.2

Chapter 5 - Tracker (only for servo instruments) _____

Overview _____ 2.5.3
 Tracker Operation _____ 2.5.3
 Controlling the tracker _____ 2.5.4

Chapter 6 - Radio _____

Overview _____ 2.6.3
 Radio controls _____ 2.6.3
 External radio _____ 2.6.5

Chapter 7 - Data Logging _____

Data Recording _____ 2.7.2
 Data Output _____ 2.7.3
 Data Communication _____ 2.7.15
 Program 54 - File Transfer _____ 2.7.17



Chapter 8 - Power Supply _____

Batteries _____ 2.8.2
 Battery Charging _____ 2.8.4

Chapter 9 - Definitions & Formulas _____ 2.9.1

Chapter 10 - Care & Maintenance _____ 2.10.1

Chapter 11 - Card Memory _____

Overview _____ 2.11.3
 Installation _____ 2.11.3
 Function _____ 2.11.4
 Memory Card _____ 2.11.8
 Handling hints _____ 2.11.9

Chapter 12 - Remote Targets _____

Overview	_____	2.12.2
RMT602	_____	2.12.2
RMT602LR	_____	2.12.3
RMT600TS	_____	2.12.3
RMT Super	_____	2.12.4



Index

A

- Alphanumeric
 - control unit 1.1.9-1.1.10
 - keying in (numeric control unit) 1.1.22
- Angle
 - measurement 1.4.1-1.4.23
 - measurement procedures 1.4.1-1.4.23
 - measurement technique 2.1.3
 - measurement two-face 2.1.6, 1.4.4, 1.4.10, 1.4.14
- ASCII
 - example 1.1.22
 - table 1.6.2
- Atmospheric correction 1.3.6
- Autolock 1.5.3-1.5.5

B

- Battery
 - adapters 2.8.3
 - cables 2.8.3
 - chargers 2.8.4
 - charging 2.8.4
 - connection 1.2.2, 1.3.2
 - external 2.8.2
 - internal 2.8.2
 - status 2.8.6
- Bat low 1.1.14, 2.8.5
- Baud rate 2.7.10
- Beam width 2.2.9
- Bulb changing (Tracklight) 2.3.5

C

- Cable
 - batteries 2.8.3
 - RS 232C 2.7.12
- Calibration

- Dual-axis compensator 1.3.4
 - Tracker 1.2.27
- Card Memory Chapter 2.11
- Care & maintenance 2.10.1
- Central Unit 1.1.7
- Coarse mode (level) 1.3.3
- Collimation 1.2.20
 - errors 1.2.20
 - measurement 1.2.20
- Compensator
 - calibration with servo 1.3.4
 - calibration without servo 1.3.5
 - On/Off 1.2.4
- Computer
 - data output 2.7.3
 - data recording 2.7.2
- Configuration menu 1.2.13, 1.2.17-1.2.18
- Configuration of main menu-App.B
- Contrast & viewing angle 1.1.13
- Control of data registration 2.7.3
- Control unit 1.1.9
 - functions 1.1.14-1.1.25
- Controls 1.1.4
- Conventional Surveying with Autolock 1.5.3
- Converter 2.8.4
- Coordinates
 - setout 1.4.29
 - station 1.3.8
- Cursor 1.3.3
- Curvature & refraction 2.9.2

D

- Data
 - logging 2.7.1
 - output 2.7.3
 - recording 2.7.2

Data Communication

- Instrument - Computer 2.7.16
- Control unit - Computer 2.7.15
- Control unit - Control unit 2.7.16
- Instrument - Control unit 2.7.16
- Instrument - Card Memory 2.7.17
- Card Memory - Computer 2.7.17
- Program 54 - File transfer 2.7.18

Date/time setting 1.2.8

D-bar

- accuracy 2.2.10
- measurements(C1) 1.4.8, 2.2.5
- measurements (C2) 1.4.10, 2.2.5
- data output 2.7.5
- R.O.E. 1.4.8

Decimal setting 1.2.16

Definitions & formulas 2.9.1

dH & dV explanation 1.4.5, 1.4.12, 1.4.19

Difference height correction 2.9.3

Display

- contrast 1.1.13
- illumination 1.1.12
- tables 1.1.13, 1.2.12
- viewing angle 1.1.13

Distance

- measurement 2.2.3
- measurement procedures 2.2.4, 2.2.5, 1.4.2, 1.4.25

Dual-axis compensator 1.3.4, 2.1.3

E _____

Eccentric point 1.5.20, 2.2.8

Electronic level key 1.1.21

Examples of measurement procedures:

- angle measurement P22 1.4.14
- one face STD 1.4.2
- two face STD 1.4.4

- fast standard FSTD 1.4.7
- one face D-bar 1.4.8
- two face D-bar 1.4.10
- tracking (tachy) 1.4.21
- tracking (setting-out) 1.4.24

External

- battery 2.8.2
- memory 2.11.1
- radio 2.6.5

F _____

Fast Standard measurement 1.2.18, 1.4.7, 2.2.4, 2.2.10

Fetch Station data 1.6.6

Field setup 1.3.2

File Transfer (Program 54) 2.7.18

Formulas & definitions 2.9.1

Function

- key 1.1.15
- list Appendix A

G _____

Geodimeter System 600

- welcome B
- software 1.1.18

Glossary of Geodimeter terms F, G

Guidelines 2.5.7

H _____

Horizontal

- angle formula 2.1.5
- angle from a line (HA_L) 1.6.7
- axis (trunnion) errors 2.1.4, 1.2.20
- distance correction (UTM) 2.2.13
- ref.. angle setting (HAref) 1.3.7
- HT_meas 1.2.17

I _____

Illumination of display 1.1.12

Info ack 1.2.17
 Info codes 1.6.9
 Inspection 1.1.3

Instrument
 calibration 1.3.4
 height 1.3.8, 2.2.10
 settings 1.1.12-1.1.13
 test 1.2.29

Internal
 battery 1.1.7, 2.8.2
 memory 2.7.20

K _____
 Keyboard see Control unit
 Keying in of alpha characters:
 Numeric control unit 1.1.22
 Alphanumeric control unit 1.1.23
 Keyclick 1.2.18

L _____
 Label
 function key 1.1.15
 recording 2.7.2
 list Appendix A
 Language setting 1.2.19, 1.6.3
 LED information 1.1.26
 Levelling of the instrument 1.3.3
 Light source (Tracklight) 2.3.5
 Lock on target 2.5.4
 Long Range 2.2.7, App.B

M _____
 Main menu Appendix B
 Measure
 angles 1.4.1-1.4.22, 2.1.1
 distances 1.4.1-1.4.22, 2.2.1
 Measuring hints 1.6.4
 Measuring time 2.2.4-2.2.5
 Memory Card 2.11.8
 Menu
 key 1.1.16

 configuration Appendix B
 Moving targets 2.2.7

N _____
 Numeric control unit 1.1.9, 1.1.22

O _____
 Office setup 1.2.2
 One face
 D-bar measurement 1.4.8, 2.2.5
 STD measurement 1.4.2, 2.2.4
 Output
 data 2.7.3
 standard 2.7.3
 user defined 2.7.5

P _____
 Packing for transport 2.10.3
 Parity settings 2.7.10
 Pcode 1.2.17
 Power
 save 1.2.18
 supply 2.8.1
 turn on 1.1.14, 1.2.3
 unit 2.8.4
 PPM
 example 2.9.5
 setting 1.3.6
 Pre-measurement 1.2.1
 Pre-settings 1.2.5
 coordinate system 1.3.10
 HAref 1.3.7
 offset 1.3.6
 PPM 1.3.6
 station data 1.3.8
 time & date 1.2.8
 units 1.2.6
 Prg_num 1.2.18
 Program
 additional 1.1.18
 key 1.1.18-1.1.19

R

- Radio Chapter 2.6
 - controls 2.6.3
 - external 2.6.5
- Range
 - general 2.2.9
- Recording data 2.7.2
- Reboot 1.6.4
- Reference Control 2.5.8
- Remote Surveying 1.5.7
- Remote targets Ch 2.12
 - RMT602 2.12.2
 - RMT602LR 2.12.3
 - RMT600TS 2.12.3
 - RMT Super 2.12.4
- Robotic Surveying 1.5.12
- R.O.E 2.2.10
- RPU Menu 1.5.25

S

- Search control 2.5.6
- Search criteria 2.5.3
- Search mode
 - Adv. lock 1.5.22, 2.5.6
 - Automatic 1.5.22, 2.5.6
 - Conflict 1.5.22, 2.5.6
 - RMT600TS 1.5.22, 2.5.6
- Search routine 2.5.7
- Sector control see Window control
- Serial commands 2.7.11
- Serial output 2.7.9
- Service 2.10.3
- Servo
 - control keys 1.1.24, 2.4.2
 - motion knobs 2.4.2
- Set
 - decimals 1.2.16
 - display 1.2.12
 - HAref 1.3.7
 - language 1.2.19
 - offset 1.3.6

- PPM 1.3.6
 - station data 1.3.7
 - switches 1.2.17
 - time & date 1.2.8
 - units 1.2.6

Setup

- field 1.3.2
- office 1.2.2

Side Cover 1.1.6**Sighting errors 2.1.6****Signal**

- height 1.3.8, 2.2.11
- level control 1.1.13, 2.2.9

Special settings 1.2.12**Standard**

- fast standard FSTD 1.2.18, 1.4.7, 2.2.4, 2.2.10
- measurement mode 1.4.2, 1.4.4, 2.2.4
- output 2.7.4

Start procedure 1.3.2**Startup 1.3.2****Station coords. 1.3.9****Station Data 1.3.8****Station establishment**

- program 20 1.3.11

Surveying methods Ch. 1.5**Switches 1.2.17****T****Table 5 1.2.15****Target data test 1.2.17****Temporary horizontal angle (HA_L) 1.6.7****Test measurements 1.2.20**

- collimation errors 1.2.21
- tilt axis errors 1.2.24

Time & date setting 1.2.8**Tracker Ch. 2.5**

- controlling 2.5.4
- operation 2.5.3

- Tracker coll. 1.2.27
- Tracking measurement
 - output 2.7.4
 - setting out 1.4.24, 2.2.6
 - tacheometry 1.4.21, 2.2.6
- Tracklight 2.3.1
 - activate 2.3.4
 - changing the bulb 2.3.5
- Transfer files 2.7.17
- Two-face measurement 2.1.6
 - D-bar mode 1.4.10
 - program 22 (servo) 1.4.14
 - STD (standard) mode 1.4.4

U _____

- Unit setting 1.2.6
- Unpacking 1.1.3
- User defined
 - output 2.7.5
 - output example 2.7.6
 - display tables 1.1.13

V _____

- VD (Vertical Distance) 2.2.11,
2.2.12
- Vertical angle formula 2.1.5
- View
 - collimation factors 1.2.21
 - trunnion axis factors 1.2.21

W _____

- Warranty 2.10.3
- Window control 2.5.5

 **Geodesical**

Welcome to Geodimeter System 600/600 Pro

Geotronics, now Spectra Precision AB, has since the release of Geodimeter System 400 presented a large number of inventions within the surveying field; the tracklight, the alpha-numeric keyboard, servo, one-person total station etc.

In 1994 Geotronics introduced the first flexible total station, Geodimeter System 600, which made it possible for the user to physically tailor his or her total station to his/her needs. In 1998 Spectra Precision AB introduce Geodimeter System 600 Pro which include a number of technical improvements such as a faster CPU and faster and smoother servo positioning.

The system includes, of course, all of the features that are typical for Geodimeter, such as servo-assisted drive (optional), numeric or alpha-numeric control units (keyboards), tracklight, tracker (optional), radio side cover (optional) and RS-232C communication.

About this manual

The contents of this manual are as follows:

Part 1. Operator's instructions

Chapter 1, Introduction, describes the contents of the transport case and the functions of the controls, control unit and display.

Chapter 2, Pre-Measurement, explains what you should do and think about when you are out measuring in the field, and what parameters should be preset. This chapter also describes how to make special settings such as the number of decimals, how to read the display, etc.

Chapter 3, Station Establishment, contains step-by-step instructions on how to set up your instrument and then establish the station at a known or an unknown point.

Chapter 4, Carrying out a Measurement, contains step-by-step instructions on how to carry out distance and angle measurements.

Chapter 5, Remote & Robotic Surveying describes the different measuring techniques that can be carried out with System 600/600 Pro.

Chapter 6, Important Pages, contains important information such as an ASCII code table, measuring hints and an Info code list

Part 2, Technical description ("Yellow Pages")

Chapter 1, Angle Measurement System, explains how the angle measurement system is built up and how it functions.

Chapter 2, Distance Measurement System, explains how distance measurement works. It covers the system's different measuring methods, accuracy, range, etc.

Chapter 3, Tracklight, explains how Tracklight works, how it is activated and how it is set.

Chapter 4, Servo, explains how the Servo is controlled.

Chapter 5, Tracker (only for servo instruments), explains how the Tracker unit operates, how to set a search sector and also how to use the remote target.

Chapter 6, Radio, explains how the Radio is controlled.

Chapter 7, Data Logging, describes how to collect and transmit data.

Chapter 8, Power Supply, explains the different types and capacities of batteries and types of chargers available for Geodimeter System 600/600 Pro.

Chapter 9, Definitions & Formulas.

Chapter 10, Care & Maintenance.

Chapter 11, Card Memory.

Chapter 12, Remote Targets.

How to use this manual

The manual for Geodimeter System 600/600 Pro is divided into two parts:

- Part 1 gives step-by-step instructions, from unpacking the instrument to advanced setting out.
- Part 2 provides a technical description of the main components of the instrument. Since all pages in Part 2 are printed on yellow paper we refer to them as the "yellow pages".

The cover also contains an appendix section, in which Appendix A is a complete list of labels, and Appendix B is an overview of the instrument's Main Menu.

The manual covers both instructions on how to use the system as an ordinary total station and how to use the system for remote or robotic surveying. When using the system for remote or robotic surveying you control the measurement from the measuring point with a keyboard unit, which we call RPU (Remote Positioning Unit).

The instructions in this manual indicates the difference between the RPU-display and the instrument-display by using different display shapes (see next page).

General instructions (control unit attached to instrument)

```
STD P0 10:19
HA: 154.3605
VA: 106.3701
```

Instructions for the RPU (detached control unit)

```
STD P0 19:12
Searching
```

In the manual we will use the following abbreviations for mechanical resp. servo instruments:

600s = Geodimeter System 600 Pro servo instruments

600m= Geodimeter System 600 mechanical instruments

Some instructions is only valid for instruments equipped with servo drive (600s). These instructions are indicated by a shaded field (see below).

Press  in front



***Servo: Rotate the instrument to C1 position by depressing the A/M key in front for approx. 2 sec. A signal is heard if the point is marked with a prism...*

If you or your colleagues have any comments about this manual, we would be grateful to hear from you. Please write to:

Spectra Precision AB
Information & Market Communication Dept.
Box 64
SE-182 11 DANDERYD
SWEDEN

OR e-mail us on info@geotronics.se

Glossary of terms used with Geodimeter Systems

Area File:	A file in a Geodimeter memory device that holds known coordinates (Pno, N, E etc.) or Roadline data.
A/M-key:	Aim/Measure button. Initiates a measurement and controls search and remote measurements.
\bar{D}:	Accurate measurement with mean value calc.
dH & dV	These values represents the collimation errors. When performing D-bar measurements in two faces these errors are blanked out and do not affect the accuracy of the measurement (HA, VA). If the values differs a lot from 0 it is recommended that you perform a test measurement (MNU 5), see page 1.2.20.
Free Station:	Also known as Resection. Location of the total station by measuring distance and/or angles to 2 or up to 10 points.
FSTD:	Fast Standard measurement, with A/M
IH:	Instrument height over the point.
Job File:	A file in a Geodimeter memory device that holds data collected in the field. This file can consist of any data.
Logon:	Entering Job file and memory unit when designing an U.D.S. with program 40.
Offset:	Length offset to measured slope distance.
Prism const:	The prism's length offset from the 0-constant.
Ref. Obj:	Reference Object, also back sight.

Glossary (cont.)

- REG-key:** The register key. This stores data in the data collector.
- RMT:** Remote Measuring Target. The special prism used when performing robotic surveying (or remote surveying with auto lock™), i.e. carrying out one-person measurements.
- R.O.E.** Remote Object Elevation. See page 2.2.10.
- RPU:** Remote Positioning Unit. The rod half of the system when performing remote or robotic surveying.
- SH:** Signal height.
- STD:** Standard measurement, with A/M
- TRK:** Tracking measurement, automatic and continuous measurement.
- U.D.S.:** User Defined Sequence. A program designed by the user determining what is collected, its order of collection and how it is displayed on the screen.

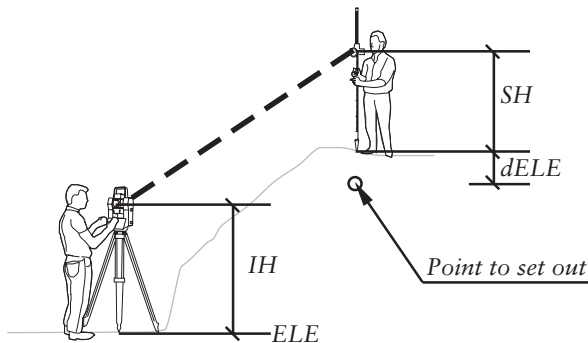

Part 1

1

Operating Instructions

Geodesical



 **Geodesical**

Introduction

Unpacking & Inspection _____	1.1.3
Unpacking _____	1.1.3
Inspection _____	1.1.3
Controls _____	1.1.5
The Side cover _____	1.1.6
The Central unit _____	1.1.7
The Control unit _____	1.1.9
Detachable control unit _____	1.1.9
Assigned control units _____	1.1.9
Additional control units _____	1.1.10
The Display _____	1.1.11
Display illumination _____	1.1.12
Reticle illumination _____	1.1.12
Contrast and Viewing Angle _____	1.1.13
User-Defined Display Tables _____	1.1.13
Key Functions _____	1.1.14
Alpha character keying in/numerical control unit _____	1.1.22
Alpha character keying in/Alpha numerical control unit _____	1.1.23
Servo Control Keys _____	1.1.24
LED Information _____	1.1.26
Illustrations _____	
Fig. 1.1 Geodimeter System 600 _____	1.1.2
Fig. 1.2 Geodimeter with alphanumeric control unit _____	1.1.8
Fig. 1.3 Geodimeter with numeric control unit _____	1.1.8
Fig. 1.4 How to attach/detach the control unit _____	1.1.10
Fig. 1.5 The system 600 display _____	1.1.11
Fig. 1.6 LED aperture _____	1.1.26

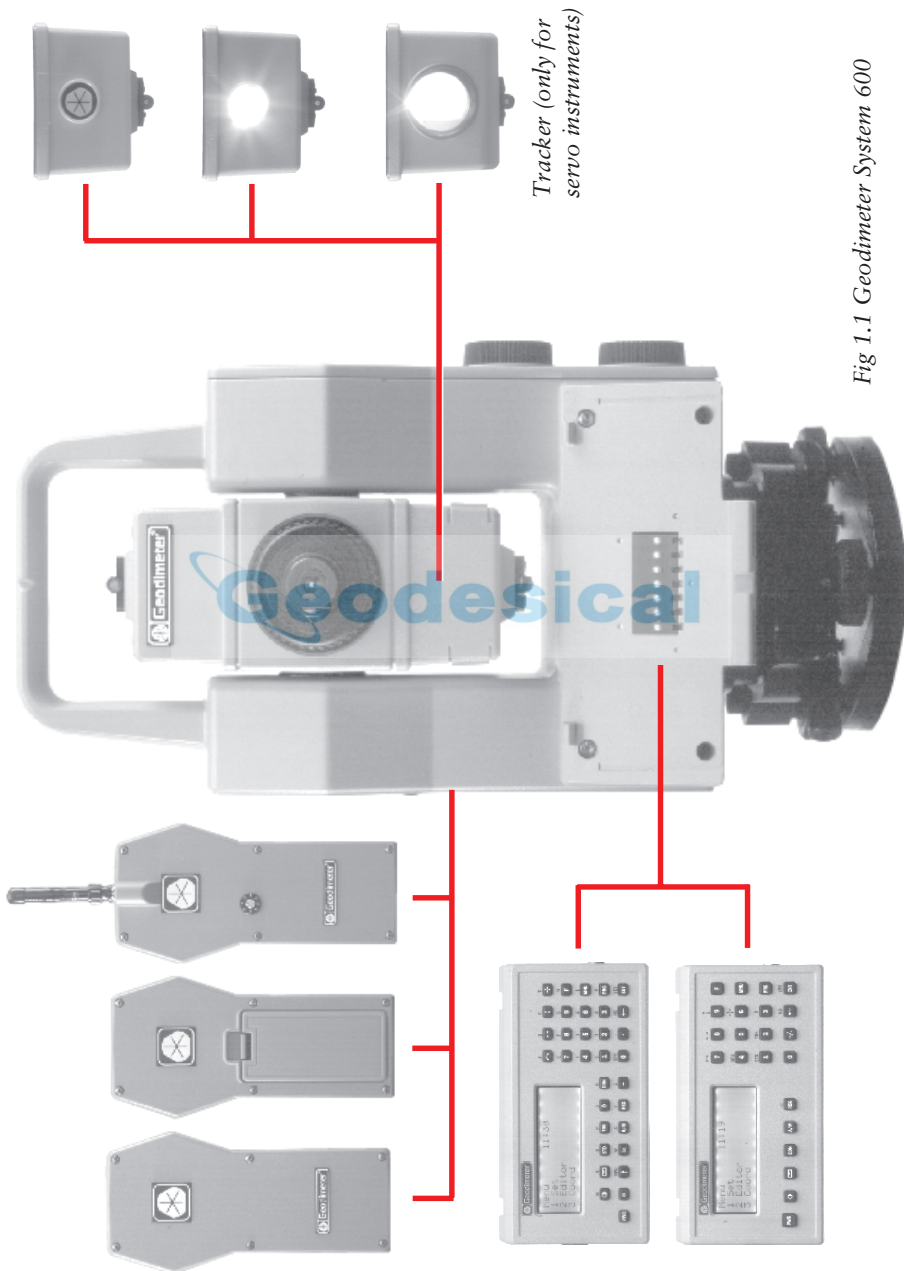

Tracker (only for servo instruments)

Fig 1.1 Geodimeter System 600

Unpacking & Inspection

Before we begin to describe the operating procedure of your Geodimeter instrument, it is first necessary to acquaint yourself with the equipment received:

- Instrument Unit
- Transport case
- Tribrach
- Rain cover
- Sight marks (stick-on)
- ASCII Table (stick-on)
- User Manuals
- Tool kit

Note!

Some equipment is market dependent

The word "Geodesical" is written in a light blue, sans-serif font. A blue curved line starts under the 'G', loops around the 'e', and ends under the 'l'.

Inspection

Inspect the shipping container. If it is received in poor condition, examine the equipment for visible damage. If damage is found, immediately notify the carrier and the Spectra Precision sales representative. Keep the container and packing material for the carrier's inspection.

Aiming at the target

To get the correct measurement with system 600 it is important that you aim at the sight marks of the target and towards the center of the range pole.

Controls

Here you find a list of the controls of your Geodimeter. Please take a moment to familiarize yourself with the names and the locations of the controls.



Geodimeter System 600 Pro shown from the operator side (back), equipped with a numeric control unit, a central battery unit and a plain side cover

Prism symbol/SP symbol

(which marks the instrument height (IH), also on the opposite side cover.)

Radio channel control

(only on the radio unit cover)

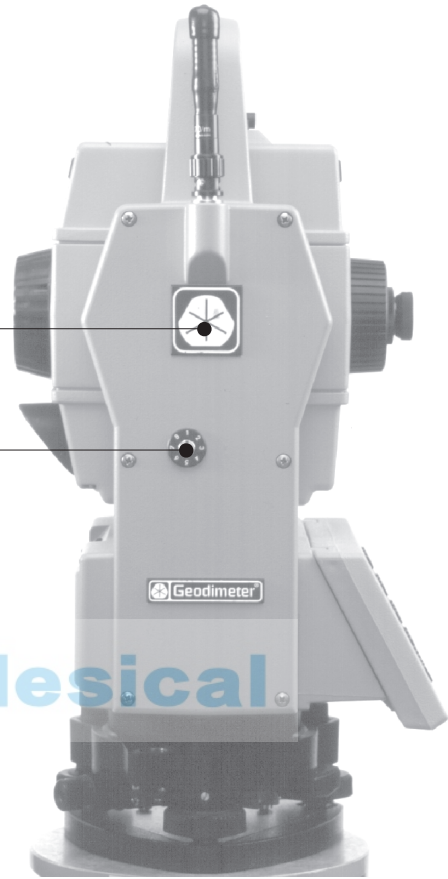

Geodimeter System 600 Pro seen from the side, equipped with a numeric control unit, a central tracker unit and a radio unit side cover

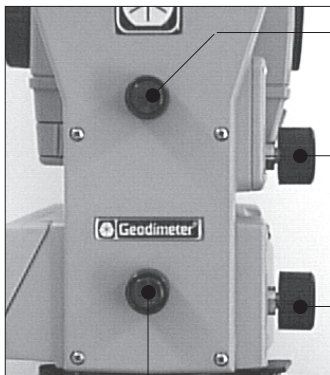

Vertical motion lock (600M)

Two-speed vertical motion control (600M)

Two-speed horizontal motion control (600M)

Horizontal motion lock (600M)

Geodimeter System 600M seen from the side.

The Side Cover

The instrument can be configured with three different side covers; a plain, a battery and a radio unit cover. It is possible to change side cover if you need another type, but it has to be done at a Geodimeter authorized service center.



Plain Cover



Battery Cover

Choose the battery cover when you wish to increase the battery power or if you wish to use tracklight without connecting an external battery. The battery will give you 2 hours of continuous use.



Radio Unit Cover

The radio unit cover is needed when you wish to use the instrument for remote surveying or robotic surveying (one-person total station), see chapter 1.5.

The Central Unit

The Central unit can be configured with the internal battery, the tracklight or the tracker unit. You can change between battery unit and tracklight by yourself, but the tracker unit must be installed at a Geodimeter authorized service center.



Internal battery

The internal battery gives you 2 hours of continuous use.



Tracklight

Tracklight is a visible guide light which is an aid to the staffman e.g. when setting out.



Tracker (only for servo instruments)

The tracker has control of the instrument when using the system for robotic surveying (one-person system) or in Autolock™ mode.



Fig 1.2 Geodimeter alphanumeric control unit



Fig 1.3 Geodimeter numeric control unit

The Control unit

The System 600 features two different control units; a numeric and an alphanumeric one.

The alphanumeric control unit simplifies the entering of point codes and basic editing by having all alpha characters on separate keys. You can, however, also enter alpha characters with the numeric control unit, but this needs extra key presses.

The control units are ergonomically and logically designed. The alphanumeric control unit consists of 33 keys: the numerals 0-9, letters A-Z, and control keys. The control keys comprise the choice of functions 0-126, choice of menu, choice of program and choice of measurement mode, together with clear and enter functions etc.

The numeric control unit consists of 22 keys, see fig 1.6.

But the control unit is more than just a keyboard, it also contains the internal memory as well as any of the softwares that are available.

Detachable control unit

The control unit is detachable and this makes it very easy for the user to transfer data. Simply detach the control unit after a survey and bring it to the office (it's very handy and fits in a normal size pocket). Attach the control unit to a computer using the multifunctional cable. Run Program 54 or Geotool to transfer data between the units.

Note! 🖱

Note!

The control unit should not be attached/detached when the instrument is switched on.

Assigned control units

In a surveying team each member can have his/her own control unit with his/her own setups, softwares and internal memory. This means that any operator can attach his/her assigned control unit to any Geodimeter System 600 and get it to work with his/her specific U.D.S's and setups.

Additional control units

With System 600 you can work with two control units attached at the same time; one at the back of the instrument that serves as a master control unit and one at the front that serves as a slave unit.

Having two control units attached at the same time can be useful having in mind that they also contain internal memories.

The control unit at the front can also be very useful when measuring in two faces when you want to keep control of the point to measure in face 2.



Fig. 1.4 How to attach/detach the control unit

The Display

The Geodimeter instrument has a four-row Liquid Crystal Display (LCD) where each row contains 20 characters. Both alpha and numerical characters can be displayed. Black images on a bright background make the display easy to read. The display has illumination and adjustable viewing angle for good readability under all conditions. The first row displays the measurement mode, program choice, clock, indication of returned signal (*) and battery condition (). If an offset or a prism offset has been set this will be



Fig. 1.5 The system 600 display

indicated by (!) between the hour and the minute in the clock. Instruments with an alpha-numeric keyboard also display if alpha mode (α), shift (\wedge) or lower case (1) is activated. The second to fourth rows display the respective labels and values of the measurement. Each display table consist of a series of "pages" which can be "turned" with the ENT-key.

MNU

1

3

Instrument
settings

Instrument settings

By pressing MNU, 1, 3 you can set the following:

- Display illumination
- Reticle illumination
- Contrast and viewing angle
- Reflected Signal volume

Press the corresponding key below "Sel" to select what to set. Use the corresponding key right below "Exit" to return to the main menu.

Display illumination

```

GUI          15:54
Illum Contrast
Reticle Vol
Sel <-  -> Off Exit
  
```

Note !

OFF indicates that the corresponding key below will turn the option off.

Press the corresponding key below "Off" to turn the illumination ON/OFF. Press the corresponding key below "<" to decrease the illumination and press the corresponding key below ">" to increase the illumination. When you have reached the maximum resp. minimum illumination one of the arrows is blanked out. The arrows will not be shown if the option is turned off. A long press on the  key will turn the display illumination on/off.

Contrast and viewing angle

```

GUI          15:54
Illum Contrast
Reticle Vol
Sel <-  -> Exit
  
```

Press the corresponding key below "<" to decrease the contrast and press the corresponding key below ">" to increase the contrast. When you have reached the maximum resp. minimum contrast one of the arrows is blanked out. The arrows will not be shown if the option is turned off. Note ! You will find that the contrast setting is most effective under cold temperature conditions.

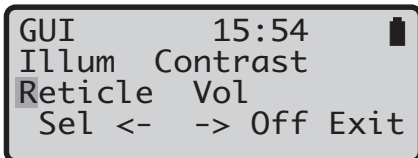
Reticle illumination

Note !
Off indicates that the the
corresponding key below
will turn the option off.

Press the corresponding key below "Off" to turn the illumination ON/OFF. Press the corresponding key below "<-" to decrease the illumination and press the corresponding key below "->" to increase the illumination. When you have reached the maximum resp. minimum illumination one of the arrows is blanked out. The arrows will not be shown if the option is turned off.

Reflected Signal Volume

Press the corresponding key below "<-" to decrease the volume level and press the corresponding key below "->" to increase the volume level. When you have reached the maximum resp. minimum level one of the arrows is blanked out. The arrows will not be shown if the option is turned off.

Hint !

Aim the instrument towards the prism so that you can hear the current volume level.

User-defined display tables

With the "Config Display" application it is possible to define your own display table, if the existing table does not fulfill your needs during the execution of a special survey application.

For further information refer to page 1.2.12.

All labels in the Geodimeter System can be displayed.

PWR

Key functions

ON / OFF key

Turns power on when pressed once, turns power off when pressed again. If no key is pressed within 60 seconds from power on the instrument automatically turns off.

When the instrument is turned on again within 2 hours from latest use you will get the question "Continue Yes/No?".

Powered off by
operator
Continue Yes/No?

If you answer yes to this question the Geodimeter returns to the mode that was current when the Geodimeter was turned off.

All the instrument's parameters and all functions, such as instrument height, signal height, coordinates, bearing, dual axis compensation, etc. are stored in the instrument for two hours. If you answer "NO" the Geodimeter is reset and some parameters are lost, e.g. IH, SH.

**Batlow
Total
Station**

If batlow occurs no measurements can be carried out. The next time (within 2 hours) the instrument is turned on you will be prompted "Powered off by battery low?". Answer yes to return to the mode that was current before battery low. Note that no measurements can be carried out before replacing the drained battery or connecting an external battery to the instrument.

**Battery
condition**

Battery condition

You can see the current capacity of the connected battery at the end of the first row in the display. As the battery becomes drained the battery symbol will change from full to empty. Note that this function depends on the battery condition and on the charging method and should only be regarded as a coarse indication.

F

Function keys/Labels

The data stored under labels can be viewed or altered by the operator. In some cases the data also influence the system. Changing the data in the time label will, for instance, set the system real time clock. However, just calling up a label, viewing the data and restoring without any editing will not influence the system at all. Data stored under labels can be retrieved by the F (Function) key or in the U.D.S (User Defined Sequences) (additional software).

A complete list of functions and labels can be found in Appendix A.

Example:

How to store a point number (Pno)

F

Turn on the instrument, press the function key, the following will be displayed.

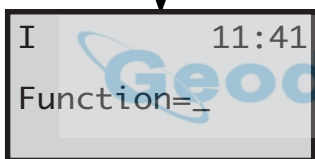

Key in the label number for point number, 5, and press the ENT-key.

5

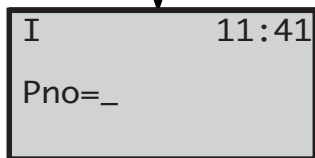

The display shows the current value for the point number. Accept the value by pressing YES or ENT or key in a new value.

2

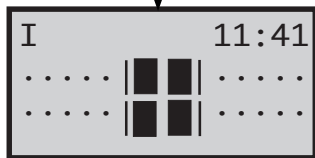

You now return to the mode that was current before you pressed the function key. The new point number is now stored in the instrument.

MNU**Menu key**

Despite sophisticated built-in technology, operation is very simple, since everything is controlled from the keyboard and the self-instructing display.

Many functions are controlled from the MNU-system that is presented on the display. The menu makes it easy to follow and alter, if required, measurement units, display tables, coordinates, correction factors etc.

The main menu configuration can be seen in Appendix B.

How to store the factor for atmospheric correction (PPM).

Example:

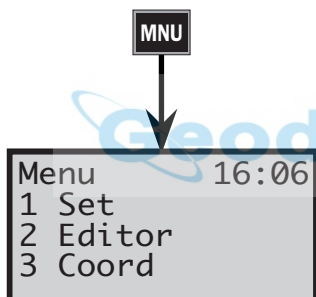

Turn on the instrument, press the MNU key, the following will be displayed.

Select SET by pressing 1 and the display shows.....

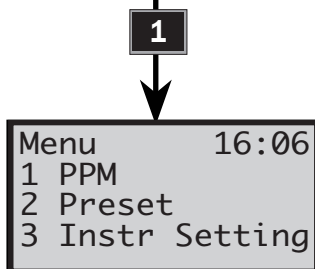

Select PPM by pressing 1 and the display shows....

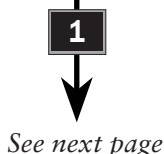

MNU

See previous page.

Set 16:06
Temp = 20.0

Key in the present value for temperature e.g + 20°C. Press ENT.....

ENT

Set 16:06
Press = 760.00

Key in the present value for air pressure e.g 760mm/Hg. Press ENT...

ENT

Set 16:06
RelHum=60.0

Key in Relative Humidity. Default is 60%. (If you have chosen Wet Temperature from MNU6.5 this will be shown instead.)

ENT

Set 16:06
RelHum=60.0
PPM=0.6

The correction factor is immediately calculated and shown in the display.

Note!  This menu is shown only if the switch "PPM Adv." is enabled in MNU6.1

Input at label 56 and 74, via Function key also alters PPM value. The PPM value can also be set directly by enter at label 30.

Fast step-through menu

When you have become well acquainted with the menu structure it is very easy to step to a submenu with a minimum of key strokes. To go to menu 1.4.1, Set time (see Appendix B) simply press the MNU-key followed by 141.

PRG

Program key

Choice of program. With this key you select the different programs installed in your Geodimeter. The programs comprise a number of different options which are listed below. The operating instructions for each program are described in a separate manual called "Geodimeter Software & Data communication".

Option	Programs Supplied
UDS	P1-19 - User Defined Sequences P20 - Station Establishment incl. 3-dim. free station P40 - Create UDS P41 - Define Label P43 - Enter Coordinates P30 - Measure Coordinates directly to an Area file
Set Out	P23 - Set Out P20 - Station Establishment incl. 3-dim. free station P43 - Enter Coordinates P30 - Measure Coordinates directly to an Area file
Pcode	P45 - Define Pcode
Edit	P54 - File Transfer
View	–
Internal Memory	P54 - File transfer
DistOb	P26 - Distance / Bearing. between 2 objects
RoadLine2D or RoadLine3D	P29 - RoadLine2D or P39 - RoadLine3D P20 - Station Establishment incl. 3-dim. free station P43 - Enter Coordinates P30 - Measure Coordinates directly to an Area file
Z/IZ	P21 - Ground/Inst. Elevation P43 - Enter Coordinates
RefLine	P24 - Reference line P20 - Station Establishment incl. 3-dim. free station P43 - Enter Coordinates P30 - Measure Coordinates directly to an Area file
Ang. Meas.	P22 - Angle Measurement (only for servo instruments)
Station Establishment	P20 - Station Establishment incl. 3-dim. free station
Area Calc.	P25 - Area & Volume Calculation
MCF	P27 - Moving Coordinates Forward
Obstructed Point	P28 - Obstructed Point
Measure Coord.	P30 - Measure Coordinates directly to an Area file
Angle Meas.+	P32 - Angle Measurement +
CoGo	P61 - CoGo
Athletics	P60 - Athletics

PRG

Choose program

There are two ways to choose a program:

1. Short press

With a short press on the program key you get the following display:

```
STD  P0  13:08
Program=20
```

Key in the desired program. In this example we key in 20, Station establishment, and press enter.

2. Long press

With a long press on the program key you step to the program menu. Here you can display all the available programs for Geodimeter System 600. Any optional program that is not installed in your instrument is surrounded by two brackets, ().

```
UDS  P0  13:08
640 632-05.00
Program 0
Dir <- -> Exit
```

*<- Current library and program number
<- Instrument model and program ver.
<- Current program name
<- Key functions*

Key functions:

- Dir** Step between the UDS-, the PRG- and the OPTIONS-library
- <- ->** Step backwards/forward in the chosen library
- Exit/MNU** Exit without starting any program
- ENT** Start the chosen program

Configuration menu

By choosing a program with a long press, you will also have the chance to configure the chosen program in most cases. See more about how to configure programs in the "Software and Data communication" manual.

ENT**Enter key**

Activates keyboard operations and turns display table pages, a switch of face or a compensator initiation.

**Clear key**

For correction of keyed in but not entered errors and to break a search routine,

STD

or

STD**1****Standard mode key**

Choice of Standard Mode. This key activates the Standard Measuring Mode. The instrument automatically assumes the STD mode after going through the Startup Procedure. Standard Mode is described in detail on page 1.4.2 and in the "yellow pages", 2.2.4. See also Fast Standard mode on page 1.4.7 and 2.2.5.

**TRK**

or

TRK**2****Tracking mode key**

Choice of Tracking Mode. This key activates the tracking measurements (continuous measurements). Tracking Mode is described in detail on page 1.4.21 and in the "yellow pages", 2.2.6.

D̄

or

D̄**3****D-bar mode key**

Choice of Automatic Arithmetical Mean Value Mode. D - bar mode is described in detail on page 1.4.8 and in the "yellow pages", 2.2.5.



Tracklight key

Tracklight ON/OFF. See more about Tracklight in the "yellow pages", 2.3.1. With a long key and one beep it turns on the display illumination. With a long key an two beeps it resets the Instrument Settings.



Electronic level key

Display of the horizontal electronic level. The electronic level on Geodimeter instruments can be levelled without the need to rotate the instrument through 90 degrees (100 gon). This is achieved by having two separate rows on the display, each with its own separate cursor, to show the level status of both axes of the instrument (see fig below). The lower cursor indicates the levelling in the measuring direction and the upper cursor indicates the levelling perpendicular to the measuring direction.

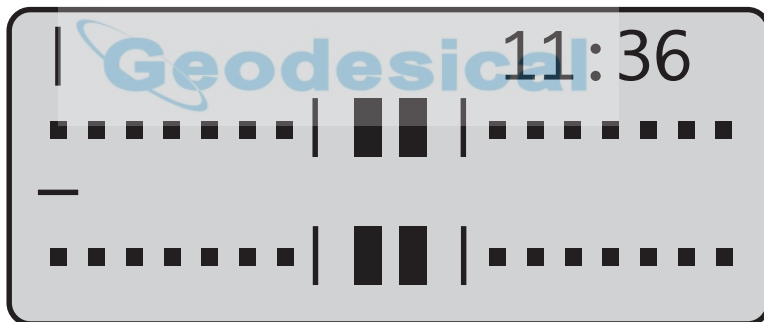

The accuracy of the electronic level, i.e. each individual left or right movement of the cursor, represents 3^{C} (300^{CC}) = approximately $1' 40''$. This level mode is termed the "coarse level mode". After calibration of the dual-axis compensator, this level mode automatically changes to the "fine level mode" which can be compared to the normal accuracy of a 1-second theodolite. In this fine mode each left or right single step movement of the cursor represents 20^{CC} (approximately $7''$). The fine level mode is designed for use during traversing using force-centering.



Measurement keys

Start of measurement cycle (STD, FSTD, D-bar). Internal storage of angle values in C2 and C1.



A/M-key at the front (on instruments with no front panel) when measuring in two faces (C1 and C2).



Registration key

For registration of measurement values. (In FSTD working with UDS this key both measures and registrates with a single press.



Alpha character keying in (numeric control unit)

It is also possible to enter alpha characters in instruments with the numeric control unit. This is done by pressing the REG-key/ASCII-key. If alpha characters are to be used in the middle of an numeric point number or point code title, exit from and re-entry into the alpha mode is achieved by pressing the REG/ASCII key. Follow the example below.

The instrument also gives you the opportunity to select special characters for different languages. This can be done via Menu 6.6. A complete list of values for different characters for different languages is shown on page 1.6.2.

Example:

Alphanumeric input using the ASCII table

The point number to be keyed in is 12 MH 66 which is the field notation for Point Number 12, which happens to be a manhole with a 66 cm diameter cover.

Press F5 and ENT. PNO is seen on the display. Key in 12. Press the REG-key/Alpha-key. ASCII is seen on the display. Key in 77 72 = MH. Press once again the REG/Alpha key. Then key in 66.

Finalize the keying in by pressing the ENT key. This ASCII possibility can of course be used with other functions – e.g. Operator, Project, etc.,etc.– in fact all functions except the labels which are directly connected with measured and calculated survey values.





Alpha mode key (alphanumeric control unit)

For activation / deactivation of the Alpha Mode. When the alpha mode is activated, it is indicated by an (α) symbol in the right-hand corner of the display.

Note! 

It is also possible to enter alpha characters in instruments with a numeric control unit, see page 1.1.22.



How to use the alphanumeric keys (alphanumeric control unit)

The numerical keys can be used both for ordinary numerals and letters. To use the letters as indicated on each key, first press key  the keyboard is now locked for letters, and this is indicated by an (α) symbol in the upper right hand corner of the display. To enter a particular numerical character in combination with an alpha character, press the key . A (^) symbol in the upper right-hand corner of the display window indicates that the shift key is activated.

For small letters, press shift  directly followed by "Lower Case" .

The figure (1) in the upper right-hand corner of the display window will appear immediately indicating lower case mode.

To return to numerical keys, press key .

The instrument also gives you the opportunity to select special characters (not shown on the keyboard). The special characters differ between languages. Language is changed via Menu 66. These special characters are displayed in the bottom row in groups of five. To step between the different characters press keys  and .

The characters are entered by first pressing shift and then the corresponding key below the character.

Lower case key (alphanumeric control unit)



Lower case is used together with the Shift key  to be able to use the alphanumeric keyboard with lower case letters. This is indicated by the figure "1" in the right hand corner of the display.



Shift key (alphanumeric control unit)

Shift Key. For entering a numeric value when the keyboard is set in the alpha mode, or vice versa and to answer NO to questions shown in the display. When the shift key is activated, this is indicated by a ^, sign in the right-hand corner of the display.

SPC



Space bar key (alphanumeric control unit)

Activated when selecting the alpha mode.

Servo Control keys (numeric and alphanumeric control units)



or



When measuring in two faces, this key is used for switching between C1 and C2.



or



Key for horizontal positioning. A short press of this key results in a horizontal positioning to the set HA Ref value. A long press of this key results in a 180°/200 Gon horizontal rotation from the instrument's current direction.



or



Key for vertical positioning.

Note - when setting out

- If you press this key without measured distance ELE=the height at the theoretical set out point.
- If you press this key with measured distance ELE=the height at the measured set out point.
- If you press this key longer than 1 sec. with measured distance ELE=the height at the theoretical set out point.



or



Key for both horizontal and vertical positioning.

CON**Continue key**

Continue key. With a press on this key you can leave the editor if you are working with an alphanumeric keyboard. In some of the internal softwares, this key can be used for exit the program.

Together with the PWR-key, this key reboots the keyboard unit, see page 1.6.4.

**5**

or

5**Temporary horizontal angle key (only in Program 0)**

The temporary horizontal angle feature in Program 0 can be useful if you want to turn the instrument without affecting the original HA. This function is called HA_L, Horizontal Angle from a Line, and results in an extra line in the display showing HA_L=0.0000. You activate the HA_L function by pressing key 5 in Program 0. Reset HA_L by pressing key 5 again. Exit HA_L with a long press on key 5. **Note that this function only works in Program 0.**

LED Information

The Geodimeter 600 instrument has been tested and complies with the regulations for a Class 1 LED product. This means that no special precautions are required for safe operation as long as the instrument isn't opened and the diode uncovered. In the figure below the LED aperture is pointed out.



Fig 1.6 LED aperture

Pre-Measurement

Office Setup _____	1.2.2
Connecting the external battery to the instrument _____	1.2.2
Connecting the external battery to the control unit _____	1.2.3
Turn on power _____	1.2.3
Pre-Settings _____	1.2.5
Units _____	1.2.6
Time & Date _____	1.2.8
Special Settings _____	1.2.12
Display _____	1.2.12
Decimals _____	1.2.16
Switches _____	1.2.17
Standard Measure _____	1.2.19
Language _____	1.2.19
Test Measurements _____	1.2.20
Correction for Collimation Errors _____	1.2.21
Correction for Trunnion Axis Tilt _____	1.2.24
Tracker calibration (only for servo instruments) _____	1.2.27
Instrument test _____	1.2.29

Illustrations

Fig. 2.1 Connecting the external battery to the instrument.

Fig. 2.2 Connecting the external battery to the control unit.

Office Setup

This chapter is to familiarize you with your Geodimeter before you enter the field. We will not follow all steps in the normal field procedure.

Connecting the external battery to the instrument

The instrument can be equipped with an external battery that is connected to the instrument via the battery cable . The cable is to be connected to the contact on the instrument resp. battery as shown in the picture below.



Fig 2.1 Connecting the external battery to the instrument.

Connecting the external battery to the control unit

When using the control unit detached from the instrument, e.g. when performing remote surveying or robotic surveying (see chapter 1.5) or when connecting it to a computer it is necessary to connect the control unit to an external battery. Connect the external battery and the control unit with the standard battery cable as shown in the picture.



Fig 2.2 Connecting the external battery to the control unit.

Turn on power

To turn the instrument on, press the On/Off key. A built in test sequence displays the following display tables.

PWR

On/Off



A built in test sequence displays Geodimeter and type number followed by....

↓
See next page

From previous page

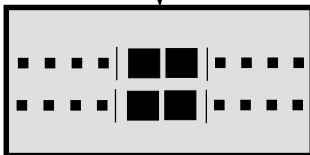

.....display of the electronic level which indicates the level status of both axes of the instrument. As no measurements are to be made we will disconnect the dual axis compensator by setting function 22 to 0.

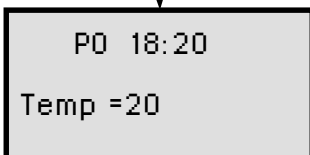

As no measurements are to be made, press only ENT.

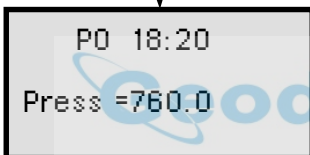

As no measurements are to be made, press only ENT.

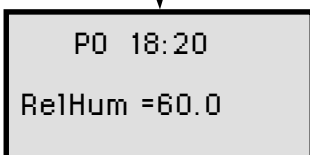

As no measurements are to be made, press only ENT.

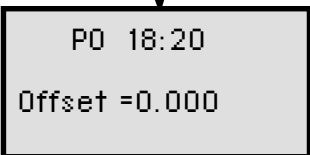

As no measurements are to be made, press only ENT.



See next page

Note!  This menu is shown only if "PPM Adv." is activated in MNU6.1

From previous page

```
PO 18:20
HA: 192.8225
HAref=
```

As no measurements are to be made, press only ENT.

ENT

```
STD PO 18:20
HA: 192.8230
YA: 91.7880
```

Here you come automatically to the Standard Measurement mode. As no measurements are going to be made at the moment, we will continue with the Pre-Setting routine.

Pre-Settings

In this exercise you will need to access Appendix B at time to time to look at the main menu configuration.

The subject Settings can be divided into three different categories:

- Measurement settings – settings of PPM, Offset, HAref and Station data. These settings will be dealt with in the section "Start Procedure" on page 1.3.2.
- Special measurement settings – these range from the setting of decimal place and defining display tables to setting different switches. These settings will be dealt with on page 1.2.12 "Special Settings".
- Pre-Setting – settings which can be decided and executed in advance are the following: MNU 65 = Unit (i.e metres, feet, grads, degrees, etc) and MNU 14 = Time & Date.

Note - Coordinate System

Start with checking your coordinate system setting with menu 67, see page 1.3.9.

Set unit (e.g metres, feet, grads, degrees, etc)

MNU

6

5

```
STD PO 18:20
HA: 192.8230
YA: 91.7880
```

Now it is time to make use of the menu function. Press the MNU key.

MNU

```
Menu 18:20
1 Set
2 Editor
3 Coord
```

You are going to begin the CONFIG routine. Press 6.

6

```
Config. 18:21
1 Switches
2 Standard Meas
3 Decimals
```

Step by pressing ENT.

Note! ←

ENT

```
Config. 18:21
4 Display
5 Unit
6 Language
```

Note!
This is not needed. If you know the "code" for desired function just key in the entire code, in this case 65 in order to save key-strokes.

You are going to set the unit parameters – i.e., metres, feet, grads, degrees, etc.
Press 5.

5

See next page

From previous page

Config. 18:22
Metre?

Answer YES or ENT to accept the displayed unit or NO if you want to change to feet. Here press ENT.

ENT

Config. 18:22
Metre
Grads?

Answer YES or ENT to accept, or NO if you want to change to degrees, decimal degrees or Mills. Here press ENT.

ENT

Config. 18:22
Metre
Grads
Celsius?

After you have answered YES or NO to the choice of temperature unit, the air pressure unit and Wet Temperature/Humidity, the display automatically changes to Program 0 and MNU1.1.

Note! "Wet Temperature" must always be a lower figure than "Temp" otherwise you'll get an error message in the display.

Note! 

See next page

Note! 
F23

By pressing F23 you can see the units you have chosen according to the following: xxx1= Grads (400), xxx2= Degrees (360, min, sec), xxx3= Decimal Degrees (360), xxx4= Mills (6400), xx1x= Meter, xx2x= Feet, x1xx= Celsius, x2xx= Fahrenheit, 1xxx= mbar, 2xxx= mmHg, 3xxx= inchHg, 4xxx= hPa.
Example: F23 shows '3121' means that inchHg, Celsius, Feet and Grads have been chosen .

Set time & date

MNU

1

4

```
STD PO 18:24
HA: 192.8230
YA: 91.7880
```

Now it is time to make use of the MNU function. Press MNU key.

MNU

```
Menu 18:24
1 Set
2 Editor
3 Coord
```

You are going to begin the SET routine. Press 1.

1

```
Set 18:24
1 PPM
2 R.O.E
3 Instr Setting
```

Step by pressing ENT or 4 directly.

ENT

```
Set 18:24
4 Clock
```

You are going to set the clock. Press 4.

4

See following page



From previous page

```
Time 18:24
1 Set time
2 Time system
```

You wish to calibrate the clock. Press 1.

Note! ←

Note!
Time and date can also be set by using function 52 (F52) and function 51 (F51).

1

```
Time 18:25
Date=1997.0607
```

These values were in the instrument at the time it left the factory. Key in today's actual values and press ENT.

ENT

```
Time 18:25
Date=1997.0607
Time=18.2540
```

Key in your time. Press ENT when the time is synchronized.

ENT

```
STD PO 18:25
HA: 192.8230
YA: 91.7880
```

You are returned to prog. P0.
If you are not used to the order of year/month/day and would rather have the normal European standard of day/month/year, press MNU.

MNU

See next page

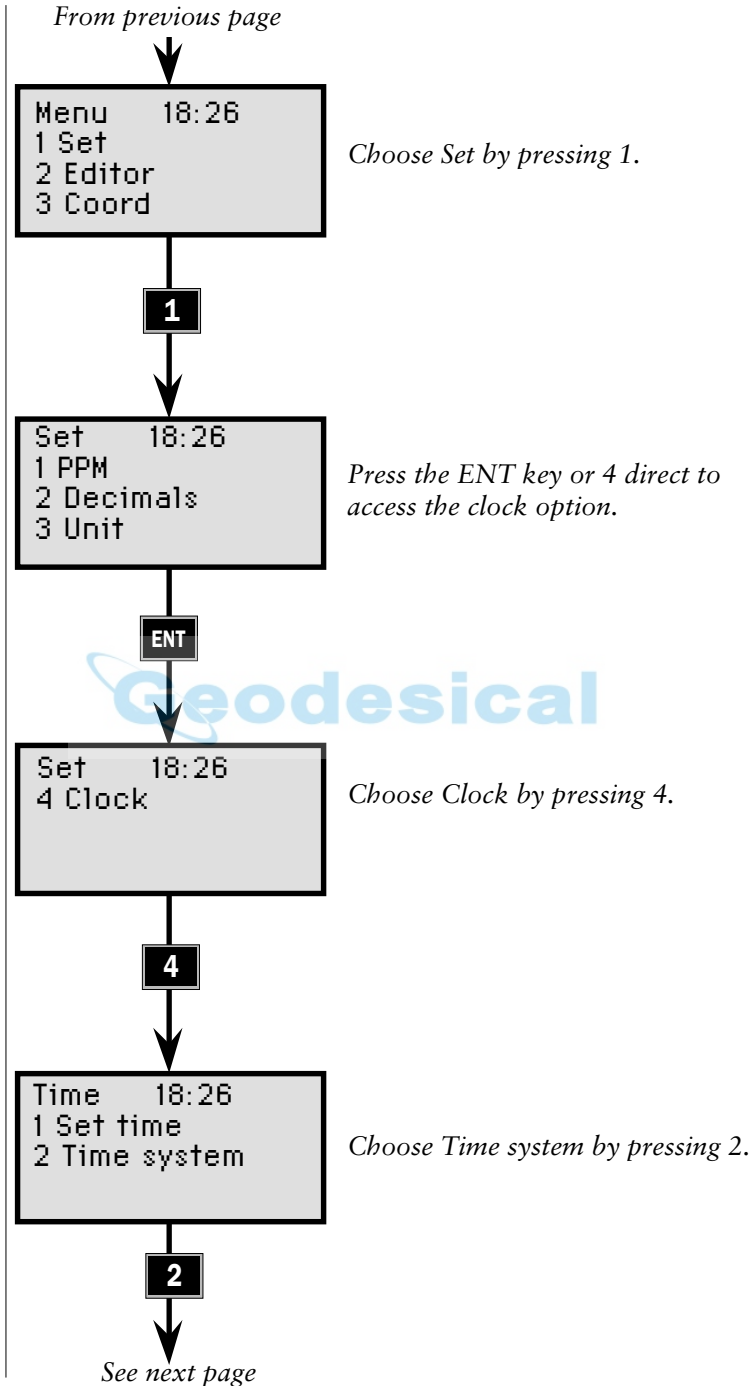

From previous page

```

Time  18:20
Numerical ?
    
```

Here you are able to select which type of date system you want – e.g Numerical?, 12h mm-dd-yyyy or 24h mm-dd-yyyy and also if you want to change to dd-mm-yyyy. Let's press YES or ENT for Numerical.

ENT

```

STD PO  18:20
HA:  192.8230
VA:  91.7880
    
```

You are returned to the Standard mode program 0 (P0).

You have now completed the pre-settings, which normally don't have to be changed.

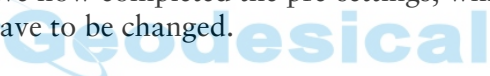

Note! ➔
Check after service

If the instrument has been delivered for service you should check time & date as these parameters might have been changed.

Note! ➔

As from program version 632-04.03 the change from year 1999 to 2000 will be handled automatically by the system. In earlier program versions you have to change the year manually using F52 and F51.

Special Settings

The special measurement settings range from defining display tables, setting decimal place and setting different switches such as: Targ. test, Pcode and Info ack.

Create & Select display tables

Various display combinations can be created by the operator. However, we consider the following 3 tables as standards and we have chosen them to be the default.

Table 0 (Standard)

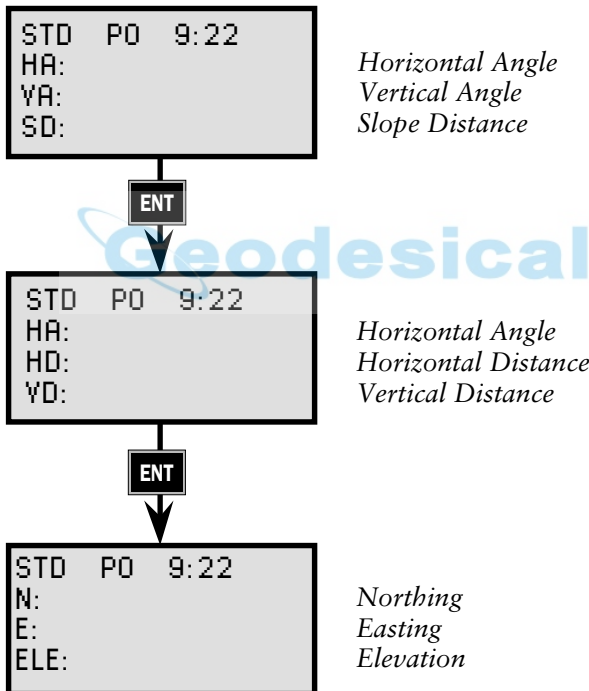

MNU

6

4

Other settings can be made with the help of the main menu using MNU 64 and option No. 2, Create Display e.g MNU 642.

There are 5 tables available (Tables 1–5). Table 0 is standard and cannot be changed (see above). 16 different pages can be defined in each table or 48 using only one table. 3 rows can be specified on each page.

Create & Select a new display

To give you an idea as to how this works, let us take a look at our standard table 0. After measuring the distance the following will be displayed:

```
STD  PO  9:22
HA:
YA:
SD:
```

Page 1

ENT

```
STD  PO  9:22
HA:
HD:
VD:
```

Page 2

ENT

```
STD  PO  9:22
N:
E:
ELE:
```

Page 3

If for example you would like to display eastings before northings, you can change the display table according to the following example: (page 1 and 2 unchanged)

Create Display

```
STD  PO  9:23
HA: 123.4565
YA:  99.8755
```

To be able to set your own display tables you have to access the main menu.

Press MNU 642.....

MNU

6 4 2

See next page

From previous page

Note! 

```
Config.  9:23
Table no=
```

Choose, for example, 1. Press 1 ENT...

*Note - table 5 !
Table 5 can not display distance measurements.*

ENT

```
Config.  9:23
Page 1 Row 1
Label no=
```

Check the list of functions labels in Appendix A. Press 7 (HA) ENT..

ENT

```
Config.  9:23
Page 1 Row 1
HA
Ok?
```

Press YES or ENT.

ENT

```
Config.  9:23
Page 1 Row 2
Label no=
```

Continue with label 8 (VA) and 9 (SD).

ENT

See next page

From previous page

```
Config. 9:23
Page 2 Row 1
Label no=
```

Continue with label 7 (HA), 11(HD) and 49 (VD) using the same procedure as for page 1.

When you have come to page 3, key in the labels below in the following order:

- 38 Easting coordinate
- 37 Northing coordinate
- 39 Elevation coordinate

```
Config. 9:23
Ready ?
```

You have now created your own display table. Press YES and you will be returned to program 0 (P0).

Select Display

```
Display 9:23
Table no=
```

To be able to use your newly created display table, select MNU 64 and option 1. Select display.

Key in the current Table No. and press ENT. This Table No. now becomes the default version, until you select another Table No.

Display table no 5

With display table 5 you can not view any distances. For this reason this table is very useful for user instructions. You can combine e.g. table 0 with table 5 as follows:

1. Name e.g. label 90 and 91 with P41 to "Aim" resp. "Press"
2. Define function 90, 91 as "to prism" resp. "A/M"
3. Create display table 5 and include label 90 and 91
4. Choose display table 0,5 (that is table 0 and table 5)
5. Before every measurement you will now see the following instruction: "Aim to prism" "Press A/M". As soon as the prism is hit you will get the angles and distances in the display.

Note! → If the data output is to be similar to your display table, then it also has to be set. See "Data Communication", "yellow pages" 2.7.4.

Number of decimals

MNU

6

3

```
STD PO 10:16
HA: 234.5678
VA: 92.5545
```

To set the number of decimals, you must first choose the service of the menu.....

MNU

```
Menu 10:16
1 Set
2 Editor
3 Coord
```

Select number 63 Set Decimals

6

3

```
Config. 10:16
No of decimals
Label no=_
```

In this example, let us change the number of decimals in, for example, the HA = label No 7.

7

ENT

```
Config. 10:16
No of decimals
HA=4
Change to=_
```

We assume that you want to work only with 2 decimal places in this example

2

ENT

```
STD PO 10:16
HA: 234.56
VA: 92.5545
```

You are now returned to the standard (STD) mode. To change other labels, choose the menu and repeat.

Note!  A complete list of Functions and labels can be found in App.A.

Note!  When TRK-mode is active some labels will only work with 2 decimals even if they are set to more decimals by the user

MNU

6

1

Switches (Targ. test on ?, Pcode on ?, Info ack off ?, HT_meas on ?, Pow.save on ?, Key click on ?, Prg_num. ?, PPM ADV.?)

Eight different switches can be set in the instrument, by using the menu's CONFIG function, Option 6, Set switches. You switch between on and off by pressing the NO key.

```
Config. 11:22
Targ.test on?
```

For activation/deactivation of the Target test; answer ENT/NO. For more information see "yellow pages" 2.2.8.

ENT

```
Config. 11:22
Targ.test on
Pcode      on?
```

When using the additional software Pcode, this allows you to switch the Pcode-table off.

ENT

```
Config. 11:22
Targ.test on
Pcode      on
Info ack.  on?
```

If you want to confirm any info message that may appear switch this label on. Any info message will then be followed by "Press any key". The display returns to normal after 3s.

ENT

```
Config. 11:22
HT_meas   on?
```

If the station height has been established in e.g. P20 (Station Establishment) you can by entering menu 61 from P0 choose whether to include the station height or not.

ENT

Note! ← HT_meas will not be displayed if the station has not been established.

See next page

From previous page

```
Config. 11:22
HT_meas  on
Pow. save on?
```

The distance meter can be set in power save, which means that the distance meter is only active during distance measurement given. This is indicated in the display with an "s". (only in STD and D-bar)

ENT

```
Config. 11:22
HT_meas  on
Pow. save on
Key click on?
```

Set keyclick on to hear a clicking sound every time you press a key.

ENT

```
Config. 11:22
Prg_num  on?
```

If Prg_num is on, the current program number will be stored first in the jobfile when you start a program (P20-P29).

ENT

```
Config. 11:22
Prg_num  on
PPM Adv. on?
```

Enabling PPM Adv. means that you base the PPM correction factor also on user defined wet temperature or humidity. Select alternative using MNU65, Units. If disabled the system uses a standard humidity of 60% for the PPM calculation.

Note! **Note-Target Test**

The Target Test is created for your safety. It prevents you from storing an old distance with new angle values. When the target test is set to off, there is a risk of this, if you forget to measure a distance when measuring the following points.

MNU

6

2

Standard Measure

With this menu you can choose the standard measuring mode, STD (Standard) or FSTD (Fast standard). The Fast standard mode is not as accurate as the Standard mode but much faster.

```
Config. 11:22
1 Standard
2 Fast Standard
```

If you prefer speed before accuracy you can switch to fast standard. This means that the standard measurements will be much faster, but you cannot measure as accurate as in normal standard mode. Fast standard mode is indicated in the display with "FSTD".

MNU

6

6

Select type of language

This function is used when you want to select special characters that might be unique for Your language. You have the opportunity to select between Swedish, Norwegian, Danish, German, Japanese, UK, US, Italian, French and Spanish. An instrument with an alpha-numeric control unit gives you the characters on the last row of the display when working in alpha mode. An instrument equipped with a numerical control unit and in ASCII mode displays the special characters by selecting the different values for different languages. See complete list on page 1.6.2.

```
Language 13:16
Sw No De Ge Ja
Uk Us It Fr Sp
1:Change
```

1 ENT



Test Measurements

MNU**5****TEST**

When the instrument arrives at your office, the horizontal and vertical collimation and horizontal axis error correction factors have been measured and stored in the memory of the instrument. These correction factors will allow you to measure as accurately in one face as you can in two faces. The instrument will correct, fully automatically, all horizontal and vertical angles that are measured in one face only.

Note!  Test measurements should be carried out regularly, particularly when measuring during high temperature variations and where high accuracy is demanded in one face.

Note!  Geodimeter System 600 can be equipped with one or two keyboard units. Test measurements should be made with the same keyboard configuration as will be used during measurement to achieve maximum measurement accuracy.

A limit of 0.02gon is set to the Collimation and horizontal axis tilt correction factors. If the measured collimation and tilt of the horizontal axis correction factors prove to be greater than this limit the instrument gives the operator a warning and will not accept the correction. The instrument should then be mechanically adjusted at the nearest Geodimeter service shop.

Measurement of Collimation & Tilt of Horizontal Axis

MNU

5

TEST

Set up the instrument in the normal way according to the start procedure instructions described in chapter 3 "Station Establishment". This test is performed at the instrument.

```
STD PO 10:16
HA: 123.4567
YA: 99.9875
```

You are now in the STD measurement mode. To begin the test procedure, press MNU 5.

MNU

5

```
Test 10:16
1 Measure Coll
2 View Coll
3 Tracker Coll
```

Here you can measure new and/or view previous values. In this example we will display the old ones first. Press 2.

2

```
Test 10:17
HA Col: 0.0059
YA Col: 0.0014
Tilt Ax: 0.0184
```

These are the values which are to be updated. Press ENT.

ENT

```
STD PO 10:17
HA: 123.4567
YA: 99.9875
```

To return to option 1, Measure, to start collimation and horizontal axis measurements, press MNU 51.

See next page

Test Procedure (cont.)

MNU

5

TEST



Note - Minimum test distance !
 It is important that the test measurements are carried out over a distance greater than 100m to achieve a correct test result.

Note! ←
 Minimum test distance = 100m

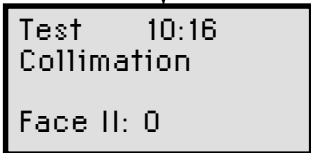

Rotate the instrument to C2 (if you have servo this is done automatically). Wait for a beep and aim accurately at the point both horizontally and vertically.

Note! ←
 Press

A/M

if you have a control unit at the front.

Press  in front

To measure and record angles, press the A/M key in front. A beep is heard...

Press  in front

Make at least two sightings to the point (the more the better), approaching from different directions, and then press A/M in front.....

Note! ←

Note!
 The same number of sightings must be made in both C2 and C1.

Rotate the instrument to C1 position* and aim at the point.

Note! ←
 Press



if you have a control unit at the front.

Press  in front

*Servo: Rotate the instrument to C1 position by depressing the A/M key in front for approx 2 sec. and aim at the point.

See next page

MNU

5

Test Procedure (cont.)

TEST

```
Test  10:18
Collimation
Face II: 2
Face I : 0
```

Aim accurately at the point both horizontally and vertically, press A/M.

C1:I

A/M

```
Test  10:18
Collimation
Face II: 2
Face I : 1
```

Make the second aiming, press A/M.

C1:II

A/M

```
Test  10:19
HA Col: -0.0075
VA Col: 0.0017
Store?
```

The second C1 angle measurement and indication of completion are very quickly shown on the display.

The display shows correction factors. Answer YES (ENT) or NO to the question Store?.

These values do not have to be zero in order for the instrument to be OK.

Note ! 

ENT

Note!

If you are not to sure about the accuracy of the displayed values, due to sighting errors for instance, you should answer No to the question Store? and repeat the measurements.

See next page

MNU

5

TEST

Test Procedure (cont) Tilt of horizontal axis

```

Test  10:20
Tiltaxis?
  
```

If you answered YES (ENT), the question for measurement of the tilt of the horiz. axis appears. Press YES (ENT).

Note!

If you consider it unnecessary to measure the tilt of the horizontal axis, you can avoid this by answering No to the question.

ENT

```

Test  10:20
Tiltaxis
Face II: 0
  
```

Rotate the instrument to C2*, aim at a point which is at least 15gon above or below the horiz. plane.

Press A/M in front after each sighting.



or



* Servo: Rotate the instrument to C2.

Wait for a beep and aim at a point which is at least 15gon above or below the horiz. plane.

Press A/M in front after each sighting.

Note! Press

A/M

if you have a control unit at the front.

Press in front

Press the A/M key in front. A beep is heard...

Press in front

Make at least two sightings to the point, approaching from different directions, and then press A/M in front.....

Note!

The same number of sightings must be made in both C2 and C1.

See next page

MNU

5

TEST

Test Procedure (cont.)

Rotate the instrument to C1 position* and aim at the point.

Press  in front

* Servo: Rotate the instrument to C1 position by pressing the A/M key in front for approx. 2 sec.

Note!  Press



if you have a control unit at the front.

```
Test 10:21
Tiltaxis
Face II: 2
Face I : 0
```

Aim at the point, press A/M.

A/M



```
Test 10:21
Tiltaxis
Face II: 2
Face I : 1
```

Make the second aiming, press A/M.

A/M

The second C1 angle measurement and indication of completion are very quickly shown on the display.

See next page

MNU

5

TEST

Test Procedure (cont.)

Test 10:22
Tiltax: 0.0150
Store?

If satisfactory, answer YES or ENT.
Press ENT.

Note ! ↗

Note!
If the horizontal axis tilt correction factor is greater than 0.02gon, a "Fail Remeasure?" message will be shown on the display. This question should be answered by Yes and the measurement procedure repeated. If the factor is greater than 0.02gon and you answer NO to the remeasurement question, the instrument will retain and use the correction factor which is presently stored in the instrument. However, if the factor proves to be greater than 0.02gon, then the instrument must be mechanically adjusted at the nearest authorized Geodimeter service shop.

ENT

STD PO 10:23
HA: 123.4567
VA: 99.9875

After answering Yes to storage of the horizontal axis tilt correction factor, you are automatically returned to the P0 start procedure.

MNU

5

3

Tracker Coll

Tracker Coll - Calibration of the tracker (only for servo)

The tracker unit, which is directing the instrument when configured for autolock, remote and robotic surveying, can obtain collimation errors in a similar way as for the optical system. Therefore test measurements should be done regularly and the new values stored.

If possible perform the test over a distance as close as possible to the distance that you are going to work at, but at least 100m.

It is important that the RMT is held very still during the test (it is recommended to use a tripod) and that it is clear sight without any obstructing traffic.

Calibration is initiated Menu 53. The instrument is calibrated with respect to Horizontal and Vertical collimation errors. These collimation errors can be stored and used to correct the measured points. The measured values are in effect until a new Test measurement is done.

Note ! Test-measurements should be done at a distance of at least 100m.

```
Test 19:12
1 Measure
2 View current
3 Tracker Coll
```

Switch on the RMT and aim the instrument towards the RMT. Enter menu 5 and start the Tracker calibration by pressing 3.

3

```
Test 19:12+
Test tracker?
```

Press the YES or ENT to perform the calibration or press NO to cancel it.

ENT

```
Test 19:12+
Please Wait
```

The instrument is now measuring in both faces towards the RMT. Please wait.

See next page

Note ! The compensator has to be initiated during this routine.

MNU

5

3

Tracker
Coll

Tracker Coll (cont)

From previous page



```
Test  19:12
Ready ?
```

The calibration is now ready. Press YES or ENT to return to P0 or NO to redo the calibration.

ENT



P0



MNU

5

4

Instrument
test

Instrument test

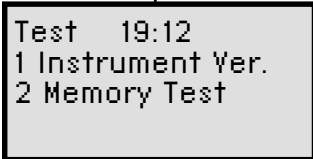
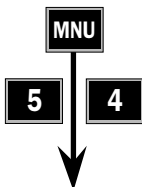

Switch on the instrument and enter menu 5-4.

Choose either 1, Instrument Ver. or 2, Memory Test.

1. If you press 1 you will be able to view the current program version installed in your instrument.
(With a long press on the PRG-key you can also see the current program version installed in your keyboard, see page 1.1.19).

2. If you press 2, the program will make a quick test of the instrument memory.

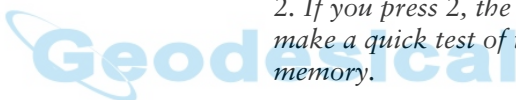

 **Geodesical**

Station Establishment

Start Procedure _____	1.3.2
Field Setup _____	1.3.2
Startup _____	1.3.3
Calibration of the Dual-Axis Compensator with servo _____	1.3.4
Calibration of the Dual-Axis Compensator without servo _____	1.3.5
Pre-Setting of PPM, Offset & HA ref _____	1.3.6
Station Data (Coord.) _____	1.3.8
Coordinate system _____	1.3.10
Station Establishment - P20 _____	1.3.11
In general _____	1.3.11
Known Station _____	1.3.12
Free Station _____	1.3.12
How to use _____	1.3.15
Known Station _____	1.3.15
Known Station+ _____	1.3.21
Free Station _____	1.3.33
Point list _____	1.3.41
Configuration _____	1.3.47

Illustrations

Start procedure

- Fig. 3.1 Fitting the internal battery.
- Fig. 3.2 Connecting the external battery.
- Fig. 3.3 Display when level appears thus "coarse mode".
- Fig. 3.4 Setting out using TRK mode.

Station Establishment

- Fig. 3.5 Programs including Station establishment
- Fig. 3.6 Free Station establishment
- Fig. 3.7 Free Station establishment with 2 known points
- Fig. 3.8 Known Station establishment with 1 ref.obj.
- Fig. 3.9 Known Station establishment with 1-10 ref.obj.
- Fig. 3.10 Free Station establishment
- Fig. 3.11 Definition of deviations in the point list

Start Procedure

The start procedure for Geodimeter instruments can be divided into two different parts:

Measurement settings which can be decided and executed in advance. These settings have already been dealt with in chapter 1.2 "Pre-Measurement", section "Pre Settings".

In this section, we will deal with calibration of the dual-axis compensator, setting of PPM, offset, HAref and station data (coord).

Field Setup

Mount the instrument on the tripod in the normal manner at a convenient working height.

Slide the internal battery along the housing of the tracklight (see fig. 3.1) or attach the external battery on the tripod and connect the battery cable (see fig. 3.2).

Note! ←
Setting up

Note !

It is assumed that the operator is familiar with optical theodolites. Setting up, centering with the optical plummet and levelling with the plate level are not described.



Fig. 3.1 Fitting the internal battery

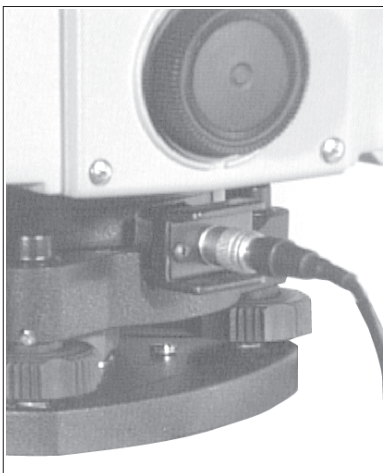

Fig. 3.2 Connecting the external battery

Startup

- ❑ Switch on the instrument and place the display of the instrument parallel to two of the foot screws of the tribrach.
- ❑ Level the instrument by first rotating the foot screws in the normal theodolite levelling manner – i.e, equal and opposite to each other

Rule: The lower bubble will follow the direction of the left thumb.

- ❑ When the cursor is in the correct position you adjust the upper bubble with the third foot screw, without rotating the instrument. Clockwise rotation of this screw will move the cursor to the right. Levelling must be within 6 c , otherwise a warning signal will be given after attempting to calibrate the compensator. The electronic level at this stage is in the "coarse mode" (see fig 3.3). "Fine mode" is achieved after calibration of the dual-axis compensator. At intervals during measurement you can view the electronic levelling bubble whenever you wish, simply by pressing the level symbol key. See more about the electronic level key on page 1.1.21.



Electronic
Level Key

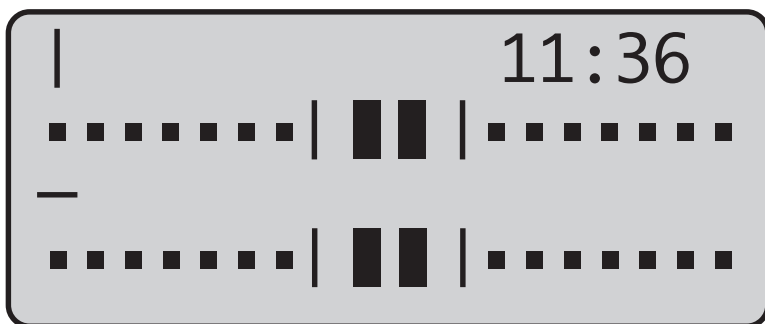
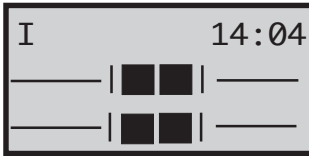

Fig 3.3 Display when level appears thus "coarse mode"

Calibration of the dual-axis compensator with servo

This should be done to get full accuracy of the systems inherent intelligence.



The instrument is levelled.
Start compensator calibration by pressing A/M- or ENT-key.



A beep is heard and the display will change to.....

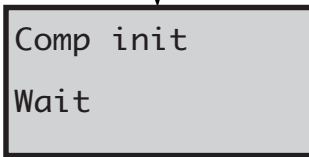

The instrument automatically turns 200 gon (180°) away from you. After a few seconds a beep is heard and the instrument turns back and the display will change to.....

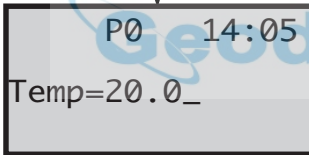

.....program 0. The appearance of P0 indicates that the instrument is sufficiently well levelled and that the compensator is now engaged. It also means that the electronic level is in the "fine mode" in which each individual left or right movement of the cursor represents 20^{CC}.

Note! ↗
Disconnect the compensator by setting function 22=0.

Calibration of the dual-axis compensator without servo

This should be done to get full accuracy of the systems inherent intelligence.

Note! ←
Disconnect the compensator by setting function 22=0.

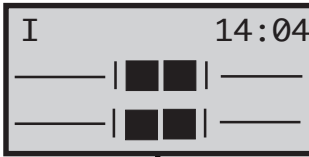

The instrument is levelled.
Start compensator calibration by pressing A/M- or ENT-key.



A beep is heard.
Wait for a double beep after approx. 6-8 sec and the display will change to.....

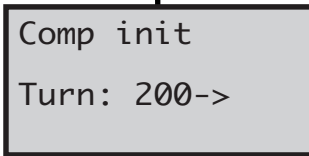

Turn the instrument 200 gon (180°) and the display will change to.....

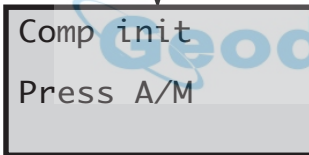

...when the instrument is within 1 gon of a 200 gon rotation.



A beep is heard and the display will change to...

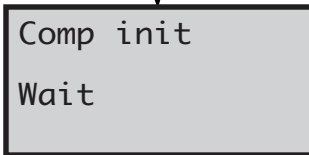

Wait for a double beep after approx. 6-8 sec. The display will automatically change to...

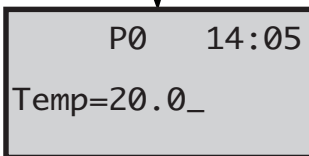

...program 0. The appearance of P0 indicates that the instrument is sufficiently well levelled and that the compensator is now engaged. It also means that the electronic level is in the "fine mode" in which each individual left or right movement of the cursor represents 20^{CC}.

Pre-setting of Temp., Press., Humidity, Offset & HRef

The pre-setting of these distance correction and angle orientation values can be entered in program 0, see below. The PPM factor can also be changed or updated with the help of the SET 1 routine in which the instrument itself will calculate the atmospheric correction factor, after you have keyed in the new temperature and pressure values. PPM, Offset and HRef angle can also be changed with the functions F30, F20 and F21 respectively. You are therefore never forced into a situation where you must accept the displayed or keyed-in values. These can be changed at any time.

P0 10:15
Temp = 20.0_

After calibration of the compensator the display will automatically change to program 0. This was the last temp. value keyed into the instrument. Accept or key in a new value.

ENT

P0 10:16
Press = 760.0_

Accept or key in a new value for pressure.

ENT

P0 10:16
RelHum=60.0_

Key in Relative Humidity in %. (If you have chosen Wet Temperature in MNU6.5 this will be shown instead.)

ENT

See next page

Note! ← This menu is shown only if "PPM Adv." is activated in MNU6.1

(cont) Pre-Setting of Temp, Press., Hum., Offset and HAref.

From previous page

P0 10:16
Offset = 0.000_

Key in the distance correction offset or accept zero value (Default value = 0). See also prism constant, chapter 1.6.

ENT

P0 10:16
HA: 123.4567
HAref= _

Key in a new HA bearing, e.g. 234.5678, zero, or accept displayed value .

ENT

P0 10:16
HA: 123.4567
HAref= 234.5678

Aim instrument to R.O. (Reference Object) and press A/M or ENT.

Note!

Note!
If you use F21 to preset the HAref angle, the instrument must be pointing at the R.O. before pressing the ENT key.

ENT

STD P0 10:16
HA: 234.5678
VA: 92.5545

The instrument automatically assumes the standard (STD) mode and it is now orientated to your own local coord. system.

At this stage you could start to choose which measurement mode you are going to use – i.e. D-bar, Tracking and Standard (automatically selected). But let's continue by setting the station data.

Station data (Instr. Height, Signal Height, Stn. Coord.)

To work with direct and immediate calculation of point coordinates and elevations, the operator can easily and quickly key in the instrument station coordinates via the main menu, option 3, Coord, or option 1, Stn. Coord. or with F37, F38 and F 39. Instrument and signal height can be keyed in via functions F3 and F6 respectively.

Let us begin this example by informing the instrument of the station data i.e. instrument height, signal height, instrument station coordinates and in that order.

```
STD  P0  10:16
HA:   234.5678
VA:   92.5545
```

To inform instrument of the instrument height, we will select function 3.....

F

F

3

3

ENT

Instrument Height

```
STD  P0  10:16
IH = 0.000_
```

The previous value is shown. Accept or key in new I.H.

F

ENT

6

Signal Height

```
STD  P0  10:16
HA:   234.5678
VA:   92.5545
```

You are now returned to the STD P0. Repeat the above instructions with function 6 (F6) to key in the signal height (SH).

After keying in IH (F3) and SH (F6), choose the menu function to access the "3 Coord" option.

MNU

See next page

(cont.) Station Data

From previous page

MNU

3

1

**Station
Coord.**

```

Menu      10:16
1 Set
2 Editor
3 Coord
    
```

Choose option No. 3 Coord....

3

```

Coord     10:16
1 Stn Coord.
2 Setout Coord.
3 Fetch Stn data
    
```

Choose option No 1. Stn. Coord.

1

```

Coord     10:16
N=0.000_
    
```

Zero or the previously entered Northing is displayed. Key in new station Northing, e.g., 100...

ENT

```

Coord     10:16
N=100
E=0.000_
    
```

Eastings, e.g., 200....

ENT

See next page

*Note ! ↗
Keying in
of SetOut
Coords
will be ex-
plained on
page
1.4.24*



(cont.) Station data

```
Coord 10:16
N=100
E=200
ELE=50
```

Elevation, e.g., 50.

ENT

```
STD P0 10:17
HA: 268.5400
VA: 92.1570
```

The Station data have now been keyed in. You are now returned to the STD P0.

At this point you have keyed in all the information which is needed to commence the survey work. And since you have now keyed in the instrument station data including the pre-calculated bearing (HAref) you will be able to see, if required, the northings, eastings and elevations of measured points on the instrument's display directly in the field.

MNU

6

7

**Coord.
System**

Coordinate System

With menu 67, Coord system, you can choose if you wish to work with a north oriented coordinate system or with a south oriented coordinate system.

```
Config. 10:16
1 North Orient
2 South Orient
```

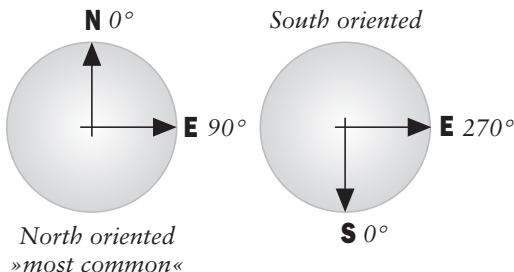

Station Establishment - In general

PRG

20

In general

Station Establishment (P20) is a basic software package for all Geodimeter field calculation programs. This program is used to calculate and store instrument setup data which is required for some of the field calc. programs. The programs that follow P20 today are SetOut, RoadLine and RefLine (see Fig. 3.5). If you try to activate any of these programs without first establishing your station, you are taken directly to P20.

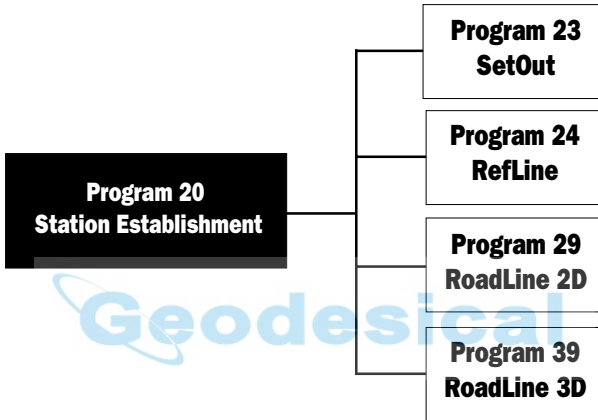

Fig. 3.5. Station establishment is necessary for running the above programs

Program 20 Station Establishment

The program is divided into three main functions:

1. Known station – for station establishment when the coordinates of your station point and reference object are known.
2. Free station – for free station establishment using 2-10 points whose coordinates are known.
3. Known station+ – for station establishment when the coordinates of your station point and up to ten reference objects are known.

PRG

20

In general

1&3 Known Station

When establishing a station at a known point, you will only need the point numbers for your station point and reference object. The instrument will then calculate bearing and distance automatically. To increase the accuracy of the bearing a new routine called "Known Station+" has been implemented in the instrument. By using this function you can measure to up to ten reference objects and also obtain a standard deviation (S_{dev}). See more about this routine on page 1.3.21.

When running Known Station in P20, you decide whether or not elevations are to be used in other calculation programs. Here you also indicate in what Job file station data and possibly other data to be calculated later will be stored, and in what Area file the coordinates are stored. See on page 1.3.31 what is stored in the selected Job file when a Known Station has been established.

Preparations

Before station establishment can take place, the coordinates and point numbers must be stored in an Area file — either in the internal memory or in an external memory such as Card Memory or Geodat — using P43 (Enter Coordinates) or downloaded from a computer. These coordinates are then used in P20 when you retrieve the correct Area file and Pno.

2. Free Station

You choose free station establishment when the station point is unknown — that is, N, E and possibly ELE will have to be calculated. This function allows free establishment in which several different combinations of objects, angles and distances can be used. The calculation is a combination of resectioning and triangulation. If you make several measurements, you obtain not only the mean value but also the standard deviation (S_{dev}). The calculation is done according to the least square adjustment method. If good

PRG

20

In general

results are to be obtained using this method, it is important that the traverses and networks are of high quality. For this reason we have provided the Free Station routine with a function called Config. (configuration). This allows you to use factors such as the scale factor (stored under label = 43), weight factors to weight your points with regard to the distance from your free station to the known point (used mainly in Germany), and also to create a point list in which all measured data for each individual measured point can be made available for editing and possible recalculation. In the example on page 1.3.33 we have chosen not to use Config. but to treat it separately on page 1.3.47.

Free station establishment can be done with a large number of different combinations of points, angles, and distances (see Fig. 3.6)

With free station establishment using 3-10 known points, the following combinations are possible:

1. Angles and distances
2. Only angles. But note that three points alone will not provide enough data to be able to calculate an optimal solution — that is, they will not give a standard deviation.

Note ! If only 3 angles are used, try to establish within the "triangle" in order to avoid the "dangerous circle".

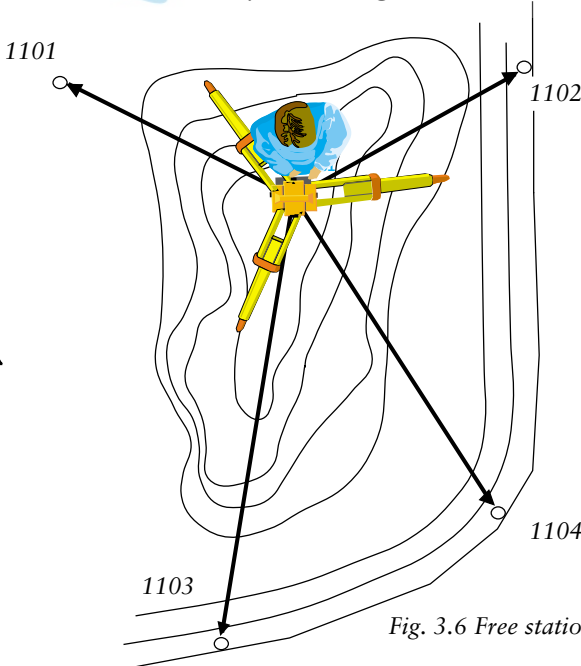
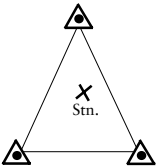

Fig. 3.6 Free station establishment

PRG

20

In general

In free station establishment with two known points, the following is valid:

1. Angles and distances.

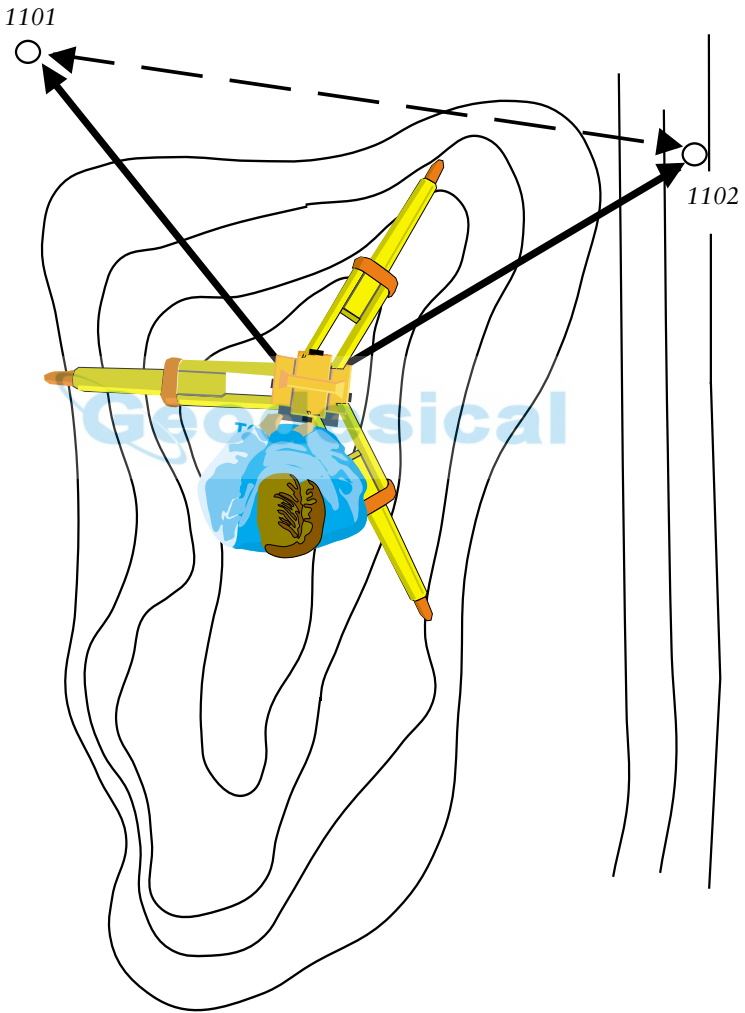

Fig. 3.7. Free station establishment with 2 known points

How to use



How to use

The examples that follow deal with three kinds of station establishment: Known Station, Known Station+ and Free Station. It is assumed that you are familiar with the operation of your Geodimeter instrument.

Switch on the instrument and go step by step through program 0 until you are in theodolite position — that is, HA and VA are shown on the display.

1 Known station

STD	P0	10:16
HA:	234.5678	
VA:	92.5545	

The instrument is now in theodolite position. Select P20 (Station Establishment).



Stn.establish 10:16
1 Known station
2 Free station
3 Known station+

In this first example we will establish a station with a known point and reference object. These are stored as Pno and coordinates in an Area file, using P43 (Enter Coordinates). Pno 1101 is our station point and Pno 1102 is our reference object, as in the example on page 1.3.16.

Now we will select option 1, Known Station.



See next page

N.B. ← An example of free station establishment is found on page 1.3.33.

PRG

20

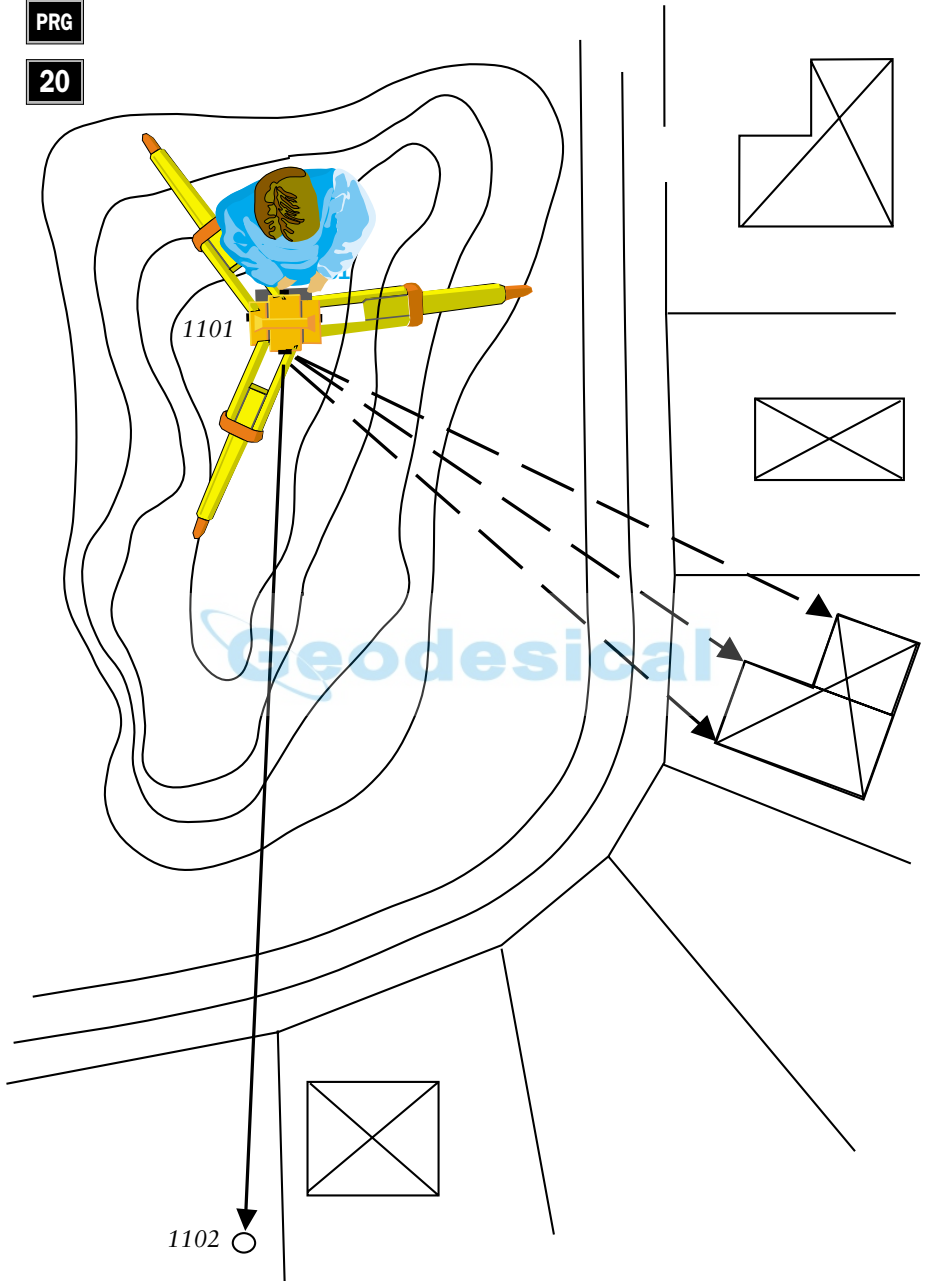

Fig 3.8. Station establishment with a known station and one reference object

Station establishment with a known station

PRG

20

Known Stn.

P20 10:16
Job no= _

Here you key in the number or name of the Job file in which you wish to store data from your station establishment. A list of data stored in the selected Job file can be seen on page 1.3.31. Select, for example, Job no = 2.

2

ENT

P20 10:17
1:Imem off
2:Xmem off
3:Serial off

Where will you store your Job file? Choose a suitable memory unit by indicating 1, 2 or 3 for activation/ deactivation. Then press ENT. Here we have chosen to work with the internal memory.

1

ENT

P20 10:17
Stn= _

Key in your station number.

1101

ENT

P20 10:17
Area= _

Key in the name of the Area file in which you have stored your station point and your reference object. If you leave the line blank you are able to enter the coordinates manually.

See next page

Note !
See note on 1.3.35.

PRG

20

Known Stn.

From previous page

1 ENT ENT

Sel device10:17
1 Xmem
2 Imem

In which memory unit is the Area file stored? In this example we are using the internal memory (Imem).

2

Coord 10:17
N=xxxx
E=xxxx
ELE=xx

Note ! Enter the coordinates manually.

Enter the coordinates manually
Enter your station coordinates. Leave the ELE blank for no height establishment. (This display will only appear if you have left the Area file line blank.

ENT

Stn ok? 10:17
N=xxxx
E=xxxx
ELE=xx

Are your coordinates correct? Press Yes (ENT) to accept them. If you press NO you will return to the question about STN= and Area=. If the coordinates have to be changed, use Edit or P43 (Enter Coordinates). In this example we will continue by accepting them.

ENT

10:17
HT measure?

Note ! Only shown if your coordinates includes ELE.

Are you going to measure heights? Accept this question by pressing ENT (Yes). If you decide not to measure heights (press No) it means that the instrument height (IH) and signal height (SH) will be ignored. In this example, we will be measuring heights. Press ENT.

See next page

PRG

20

Known Stn.

Note !  Only shown if your coordinates includes ELE.

Note !  Only shown if your coordinates includes ELE.

From previous page

10:18

ELE= x.xxx
Replace Z?

This is your old station ground elevation. Press ENT (Yes) if you want to replace the old elevation with the new or press NO to cancel it. In this example we press ENT. (This display will only appear if the ground elevation has already been determined).

ENT

10:18

IH=

Enter your instrument height (IH). For example, 1.75.

1.75

ENT

10:18

Refobj=

Key in the Pno of your reference object. For example, 1102.

1102

ENT

10:18

Area=

Key in the name of the Area file in which you have stored your reference object. If you leave the line blank you will have the opportunity to enter the coordinates manually in the same way as for the station coordinates.

1

ENT

Ref ok ?
N=xxxx
E=xxxx
ELE =xx

Are your coordinates correct? Press ENT to accept them. If you press NO you return to the question Refobj=. If they have to be changed, use Edit or P43 (Enter Coordinates). We will continue by accepting them.

PRG

20

Known Stn.

From previous page

ENT

10:18
Aim to refobj.
Press A/M

Aim at your reference object. Then press the A/M key.

A/M

STD P20 10:18
HA ref: xx.xxxx
HA: : xx.xxxx
Reg=Exit

HAref is the calculated bearing between the station point and the reference point.
If you wish to check the distance to the reference object, press ENT.
Otherwise press REG to store the station establishment.

ENT

STD P20 10:18
SHD: xxx.xxx
HD :
Reg=Exit

If the reference object is marked with a reflector, you can also check the horizontal distance by pressing the A/M key.
Otherwise press REG to store the station establishment.

A/M

STD P20 10:19
SHD: xxx.xxx
HD : xxx.xxx
Reg=Exit

Here you can compare the calculated distance with the actual measured distance. Press REG to store station establishment in the Job file you have chosen (see page 1.3.17).

Note !
PRESS
REG

REG

Note !
The REG key must always be used if you want to store the station establishment.

PRG

20

3 Known station+ (known station with 1-10 reference objects)

STD	P0	10:16
HA:	234.5678	
VA:	92.5545	

The instrument is now in theodolite position. Select P20 (Station Establishment).

PRG

20

ENT

Stn.estab	10:16
1.	Known Station
2.	Free Station
3.	Known Station+

In this first example we will establish a station with a known point and reference objects. These are stored as Pno and coordinates in an Area file, using P43 (Enter Coordinates). Pno 1101 is our station point and Pno 1102, 1103 and 1104 are our reference objects, as in the example on page 1.3.22. Now we will select function 3, Known Station+.

Note ! ← An example of free station establishment is found on page 1.3.33

3

See next page.

PRG

20

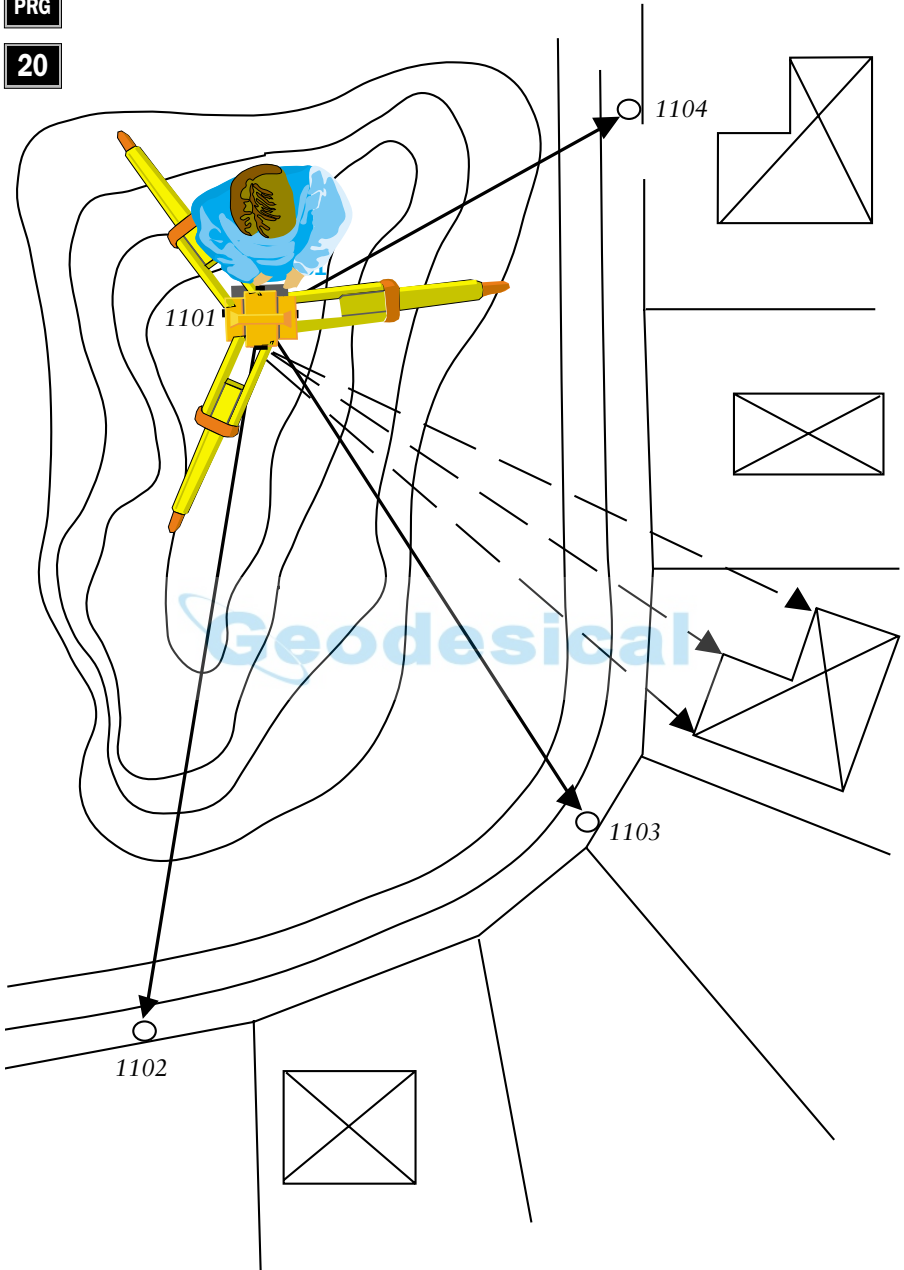

Fig 3.9. Station establishment with a known station and 1-10 reference objects

PRG

20

Known stn+

Station establishment with Known station+

P20 10:16
Job no =

Here you key in the number or name of the Job file in which you wish to store data from your station establishment. A list of data stored in the selected Job file can be seen on page 1.3.31. Select, for example, Job no = 2.

2

ENT

P20 10:17
1. Xmem off
2. Imem off
3. Serial off

Where will you store your Job file? Choose a suitable memory unit by indicating 1, 2 or 3 for activation/deactivation. Then press ENT. Here we have chosen to work with the internal memory.

2

ENT

P20 10:17
Stn =

Key in your station number.

1101

ENT

P20 10:17
Area =

Key in the name of the Area file in which you have stored your station point and your reference object. If you leave the line blank you are able to enter the coordinates manually.

See next page.

PRG

20

Known stn+

From previous page

1 ENT

```

Sel device10:17
1 Xmem
2 Imem
  
```

In which memory unit is your Area file stored? In our example, we are using the internal memory (Imem).

2

From previous page

```

Coord 10:17
N=xxxx
E=xxxx
ELE=xx
  
```

Enter the coordinates manually

Note ! ← Enter the coordinates manually

Enter your station coordinates. Leave the ELE blank for no height establishment.

ENT

```

Stn ok ?
N=xxxx
E=xxxx
ELE=xx
  
```

Are your coordinates correct? Press Yes (ENT) to accept them. If you press No you will return to the question about Stn= and Area=. If the coordinates have to be changed, use Edit or P43 (Enter Coordinates). In this example we will continue by accepting them.

YES

```

10:17
HT measure ?
  
```

Are you going to measure heights? Accept this question by pressing ENT (Yes). If you decide not to measure heights (press No) it means that the instrument height (IH) and signal height (SH) will be ignored. In this example, we will be measuring heights. Press YES.

Note ! ← Only shown if your coordinates includes ELE.

See next page.

PRG

20

Known stn+

Note ! ←
Only shown if your coordinates includes ELE.

Note ! ←
Only shown if your coordinates includes ELE.

From previous page.

YES

10:18
ELE= x.xxx
Replace Z?

This is your old station ground elevation.
Press YES (ENT) if you want to replace the old elevation with the new or press NO to cancel it. In this example we press YES.
(This display will only appear if the ground elevation has already been determined).

YES

10:18
IH =

Enter your instrument height (IH).
For example, 1.75.

1.75 ENT

Pno =

Key in the Pno of your reference object. For example, 1102.

1102 ENT

Area =

Key in the name of the Area file in which you have stored your reference object. If you leave the line blank you will have the opportunity to enter the coordinates manually in the same way as for the station coordinates.

1 ENT

Ref ok ?
N=xxxx
E=xxxx
ELE =xx

Are your coordinates correct? Press YES to accept them. If you press No you return to the question Refobj=. If they have to be changed, use Edit or P43 (Enter Coordinates). We will continue by accepting them.

PRG

20

Known stn+

Note ! ←
Only shown if height should be determined

From previous page

YES

10:18
SH: 0.000_

Enter the signal height (SH) and press ENT

ENT

STD P20 10:18*
HA: xxx.xxxxx
VA: xxx.xxxxx

The instrument is now in theodolite position and is ready to measure. Aim at the chosen target. Press the A/M key if distance is to be measured, otherwise REG.

A/M

STD P20 10:18*
HA: xxx.xxxxx
VA: xxx.xxxxx
SD: xxx.xxx

The instrument displays HA, VA and SD for your first point. Your measurement can now be registered. Press the REG key.

REG

Result
Diff HD: -0.003
Ref ok?

Here the difference between measured and theoretical horizontal distance (HD) is shown. Press YES to accept or NO to redo the measurement or select another reference point.

Note ! ←
Diff HD is shown only if distance has been measured

YES

PRG

20

Known stn+

From previous page

10:19
more?

Are you going to use more points for your station establishment, or are you satisfied with only one? In our example we will measure and register two more points (maximum number = 10). Press YES.

YES

10:19
Pno = xxxx

Enter the next Pno to be used for your known station (the display here shows the most recently used Pno). Then press ENT.

Note !

ENT

Note!
The points selected for your station establishment can be measured in any order.

Ref ok?
N=xxxx.xxx
E=xxxx.xxx
ELE=xxx.xxx

Are your coordinates correct? Press YES or NO. If they have to be changed, use Edit or P43 (Enter Coordinates). In this case, we'll answer YES.

YES

10:20
SH=0.000

Enter the signal height (SH). In this case 1 and press ENT.

Note !
Only shown if your coordinates include ELE.

1

ENT

PRG

20

Known stn+

From previous page

STD 10:20*
HA: xxx . xxxxx
VA: xxx . xxxxx

Aim towards your target, then press the A/M key to measure.

A/M

STD 10:20*
HA: xxx . xxxxx
VA: xxx . xxxxx
SD: xx . xxx

The instrument has now measured angles and distance to the second point of your known station establishment. Press REG to register your measured data.

REG

Result
Diff HD:0.003
Diff HA:0.0032
Ref ok?

Diff HD is the difference between measured and theoretical horizontal distance to the second point. Diff HA is the difference between theoretical and measured angle between point 1 and 2. Press YES to accept or NO to redo the measurement.

YES

Note! If more than 2 points have been measured, Diff HA will be replaced by S_dev HA, i.e the standard deviation of the horizontal angles.

STD 10:21
more?

Are you going to use more points for your station establishment, or are you satisfied with two? In our example we will measure and register one more point (maximum number = 10). Press Yes.

YES

Note! If you are using a servo instrument press the key to position to point 2-10. Fine adjust manually.



PRG

20

Known stn+

Note! If you are using a servo instrument press the key to position to point 2-10. Fine adjust manually.

From previous page.

10:22
Pno =

Key in the third point to be used, and repeat the procedure described above. In this example, we have measured and stored a total of three points whose coordinates are known for our known station.

Assuming that these have been measured and registered, let us continue directly to the question "more?" after storing the last point.

10:22
STD
more?

All points to be used for our known station establishment are now stored. Answer "more?" with NO. The program immediately calculates your station coordinates.

NO

10:22
Select
1 Exit
2 Point list
3 Recalc

Now you're taken to the Select menu. Here you can choose to either exit P20, edit the point list, recalculate the point data or add more points. (You can switch between the two pages by pressing the ENT button). In this example we choose to edit the point list. Press 2.

ENT

10:22
Select
4 Add point

2

PRG

20

Known stn+

From previous page.

```

On?
Pno: xx
Diff HD: -x.xxx
Diff HA: x.xxxx

```

Here you can choose which points you want to use in the point list. Choose On, Off or Delete by pressing the NO button, then accept with ENT.

ENT

```

Result
List:3    Used:3
S_dev HA:x.xxxx
Press ENT

```

When you have chosen your points for the point list and accepted with ENT, calculation automatically starts and the result is shown in the display. Press ENT to exit to the Select menu.

ENT

```

Select    10:23
1 Exit
2 Point list
3 Recalc

```

Now you're taken back to the Select menu. Here you can choose to either exit P20, edit the point list once again, recalculate the point data (i.e se the result once again) or add more points.

ENT

(Switch between the pages with ENT).

```

Select    10:23
4 Add point

```

Press 4 if you want to add points to improve the result. In this example we're satisfied with the result. Press 1 to exit P20.

Note that the current instrument direction is stored as HA_ref.

1

PRG

20

**Store data
Known Stn**

Job File (1 ref point)		Job File (2-10 ref points)	
Job File		Stn	2
Stn	2	Stn Coordinates	37,38,(39)
Stn Coordinates	37,38,(39)	RefObj	5
RefObj	62	SH	6
RefObj Coords	37,38,(39)	RefObj Coords	37,38,(39)
HA_ref*	21	Raw data	7,8,(9)
HD	11	Weight =s/1 if OFF	0
IH	3	Info: Diff HA or S_dev HA	0
		Info: Point list	0
		RefObj	5
		Delta HD (if available)	76
		Delta HA	45
		Stn	2
		Stn Coordinates	37,38,(39)
		RefObj=Blank	62
		RefObj Coords=0.000	37,38,(39)
		HA_ref*	21
		HD=0	11
		IH	3

Here are the data that can be stored in the Job file you have chosen.

** HA_ref for Known Station = calculated and Set HA,
HA_ref for Known Station+ = Current instrument direction when exiting P20.*

PRG

20

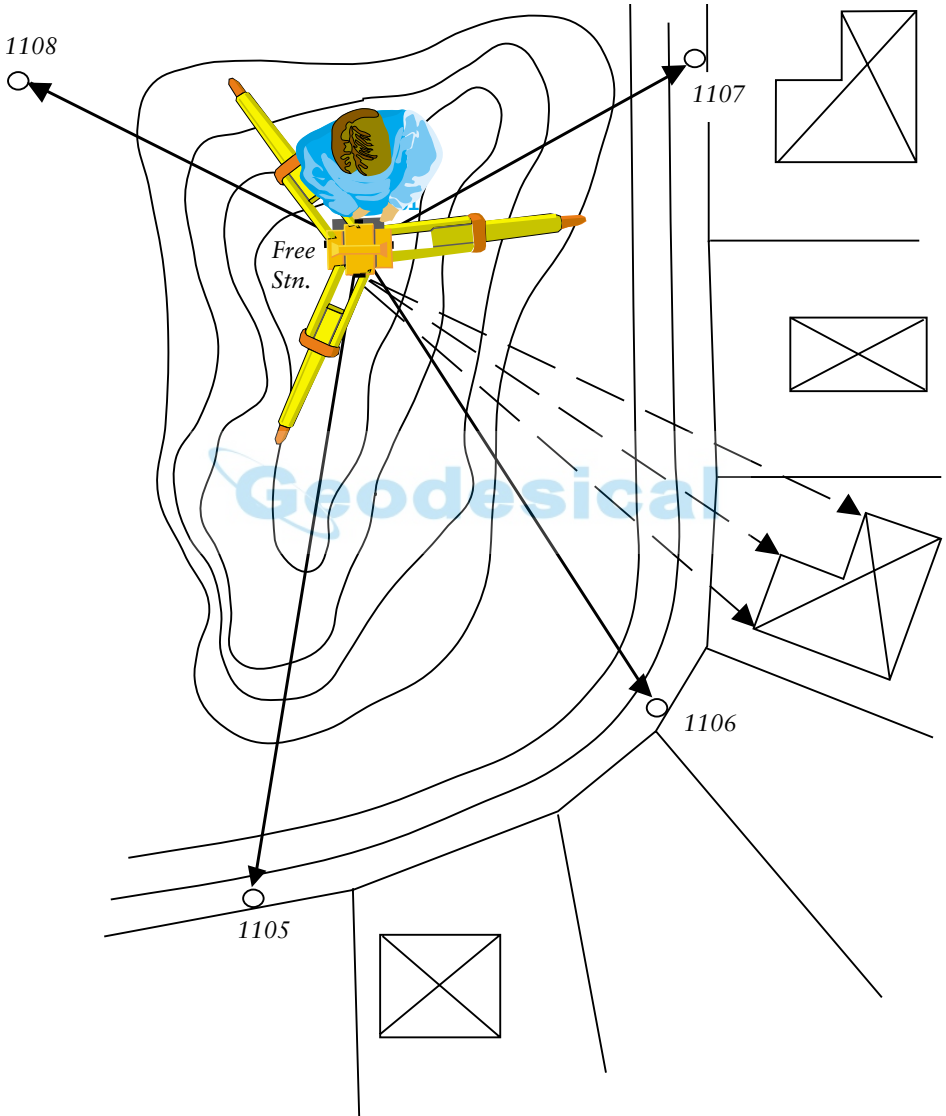

Fig 3.10. Free station establishment

PRG

20

Free stn

Free station establishment

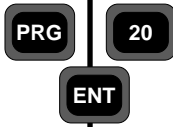

Select Program 20.

```

Stn estab.10:19
1.Known Station
2.Free Station
3.Known Station+
  
```

In this example, we will establish a free station. The known points we will be using have been stored as Pno and coordinates in an Area file using P43 (Enter Coordinates). We'll choose function 2, Free Station.

2

```

P20 10:19
Job no =
  
```

Here you key in the number or name of the Job file in which you wish to store data from your station establishment. A list of data stored in the selected Job file can be seen on pages 1.3.44, 46. Select, for example, Job no = 20.

20

ENT

```

P20 10:19
1. Xmem off
2. Imem off
3. Serial off
  
```

Where will you store your Job file? Choose a suitable memory unit by indicating 1, 2 or 3 for activation/ deactivation. Then press ENT.

2 ENT

See next page.

PRG

20

Free stn

From previous page



P20 10:20
Stn =

Here you enter a name/number for your free station. You decide this for yourself.

ENT



P20 10:20
HT Measure?

Are you going to measure heights? Accept this question by pressing YES (ENT). If you decide not to measure heights (press No) it means that the instrument height (IH) and signal height (SH) will be ignored. In this example, we will be measuring heights. Press YES.

YES



See next page.



PRG

20

Free stn

Note ! ←
Only shown if height should be determined.

From previous page.

P20 10:20
IH=0.000

Enter your instrument height (IH).
For example 1.75

1.75

ENT

P20 10:20
Area =

Key in the name of the Area file in which you have stored your known Pno and coordinates. Then press ENT.

ENT

Sel device10:20
1. Xmem
2. Imem

In which memory unit is your Area file stored? In our example, we are using the internal memory (Imem).

Note ! ←
Info 32

2

Note !

If you get Info 32 when selecting a memory unit, it may be due to one of the following:

1. You have chosen the wrong memory unit.
2. The Area file you are looking for is not located in the memory you have selected.
3. The Stn (Pno) which you are looking for is not stored in the Area file you have selected.

The program will then return to the question "Area =" so that you can enter another Area file number or point number.

See next page.

PRG

20

Free stn

From previous page.

10:21

Pno =

Enter the number of the first point you want to aim at. Then press ENT.

ENT

Pno ok?

N = xxxxxx.xxx

E = xxxxxx.xxx

ELE = xxx.xx

Are your coordinates correct? Press YES (ENT) to accept them. If they have to be changed, use Edit or P43 (Enter Coordinates). In this example we will continue by accepting them.

YES

10:21

SH = 0.000

Enter the signal height (SH). For example 2.1 and press ENT.

2.1

ENT

Note ! Only shown if height should be determined.

See next page

PRG
20
Free stn

From previous page.

STD 10:21*
HA: xxx.xxx
VA: xxx.xxx

The instrument is now in theodolite position and is ready to measure. Aim at the chosen target. Press the A/M key if distance is to be measured, otherwise REG.

Note!

A/M

Note!
Distance measurement must be carried out when measuring heights.

STD 10:21*
HA: xxx.xxx
VA: xxx.xxx
SD: xxx.xx

The instrument displays HA, VA and SD for your first point. Your measurement can now be registered. Press the REG key.

REG

10:21
Pno =xxxx

Enter the next Pno to be used for your free station (the display here shows the most recently used Pno). Then press ENT.

Note!

ENT

Note!
The points selected for your station establishment can be measured in any order.

See next page.

PRG

20

Free stn

```

Pno ok?
N=xxxx
E=xxxx
ELE=xxx
  
```

Are your coordinates correct? Press YES or NO. If they have to be changed, use Edit or P43 (Enter Coordinates). In this case, we'll answer YES.

YES

```

10:21
SH=0.000
  
```

Enter the signal height (SH). In this case 3 and press ENT.

3

ENT

```

STD 10:21*
HA:xxx.xxx
VA:xxx.xxx
  
```

Aim at your target. Then press the A/M key to measure distance.

A/M

```

STD 10:21*
HA:xxx.xxx
VA:xxx.xxx
SD:xx.xx
  
```

The instrument has now measured angles and distance to the second point of your free station establishment. Your measured data can now be registered.

REG

See next page.

Note !
Only shown if your coordinates include ELE.



PRG
20
Free stn

From previous page.

STD 10:21
more?

Are you going to use more points for your station establishment, or are you satisfied with only two? Note! If complete measurements have been carried out — that is, angles and distances — two points will suffice. If, on the other hand, only angles have been measured, at least three points are needed. This is not an optimal solution, and the display warns you with the message "Not Optimized". In our example we will measure and register two more points (maximum number = 10). Press YES.

YES

10:22
Pno =xxxx

Key in the third point to be used, and repeat the procedure described above. In this example, we have measured and stored a total of four points whose coordinates are known for our free station.

Assuming that these have been measured and registered, let us continue directly to the question "more?" after storing the last point.

Note!
If you are using a servo instrument press the  key to position to point 3-10. Fine adjust manually.

STD 10:22
more?

All points to be used for our free station establishment are now stored. Answer "more?" with NO. The program immediately calculates your station coordinates.

NO

See next page.

PRG

20

Free stn

From previous page.

```

STD      10:22
N: xxxxxx.xxx
E: xxxxxx.xxx
S_dev: x.xxx

```

These are your new station coordinates plus any standard deviation there may be. To see the standard deviation in N and E plus the scale factor used, switch the display by pressing the ENT key.

ENT

```

STD      10:22
S_devX:xxx.xxx
S_devY:xxx.xxx
SF = 1.00000

```

This is the standard deviation in N and E plus the scale factor used (scale factor = 1.0000 if it is off.) Press ENT.

ENT

```

STD      10:22
ELE = xxx.xxx
S_devZ= x.xxx

```

Here is your calculated station elevation shown if you have chosen to measure heights.

Here you can also see the standard deviation based on all observations. If the standard deviation or difference in elevation (in the case of 2 points) is to large redo the measurement again without storing the actual.

ENT

See next page.

Note !  Pointlist OFF, see page 1.3.45

Note !

On the following pages we will describe how to use the point list. See page 1.3.45 if you have deactivated the point list.

PRG

20

How to use - Pointlist ON

How to use the point list

In this example we will take a closer look at the point list which is obtained after you have established your free station (here we assume that the point list has been activated under "Config.").

The point list allows you to look at, and deactivate, any deviations there may be for each point. The deviations are displayed as "dev. =" (radial deviation) and "RT ofs/Radofs" (right offset and radial offset). We'll select point 1.

```
Free Stat.10:16
1. Pointlist
2. Recalc.
3. Exit
```

1

```
Free Stat.10:16
1. dev.
2. RT ofs/Radofs
```

Here you can look at 1 (dev = radial deviation). If there is a major radial deviation, you can make a more detailed analysis by selecting 2 (RT ofs/Radofs).

1

This is the difference in distance — that is, how much to the left (- value) or right (+ value) your theoretical point lies relative to your measured point (see Fig. 3.11, page 1.3.48). Select activation/deactivation and then press ENT.

2

```
Pno = 1
RT ofs=x.xxx on=1 off=0
```

```
STD 10:16
Pno = 1
Diff = x.xxx
```

Here the radial error is displayed for point no. 1. For an explanation of "dev", see page 1.3.48. By pressing ENT you can check the radial errors for all the points.

ENT

```
Pno = 1
Radofs=x.xxx on=1 off=0
```

This is the difference in distance between your measured point and the theoretical point, along the line of measurement. A minus sign indicates that the measured point lies beyond the theoretical point. A plus sign indicates that it is ahead of that point.

See next page.

See next page.

PRG

20

How to use - Pointlist ON

From previous page.

ENT

This page is shown for all points that have 2 coordinates and one measured distance. Any one of these points can be used for calculation of the station height. The displayed value is the difference between the calculated average height and the height, calculated from this point only.

From previous page.

ENT

Pno = 1
dELE = XXX on
on=1 Off=0

Free Stat.10:16
1. Pointlist
2. Recalc.
3. Exit

After going through the point list and possibly deactivating one or more parameters of your points, you will have to recalculate using the coordinates you want for your free station establishment. Do this by selecting function 2, Recalc.

2

STD 10:16
N: 61732.568
E: 21806.327
S_dev: 0.002

These are your new station coordinates together with the resulting standard deviation in N and E. To see the standard deviation in N and E plus the scale factor used, switch the display by pressing the ENT key.

ENT

STD 10:16
S_devX:
S_devY:
SF = 1.00000

This is the standard deviation in N and E plus the scale factor that has been used (scale factor = 1.0000 if it is Off). Press ENT.

ENT

See next page.

PRG

20

How to use - Pointlist ON

From previous page

```

STD      10:16
ELE = xxxx.xxx
S_devZ = x.xxx
  
```

Here is your calculated station elevation shown if you have chosen to measure heights.

Here you can also see the standard deviation based on all observations. If the standard deviation or difference in elevation (in the case of 2 points) is to large redo the measurement again without storing the actual.

ENT

```

Free Stat.10:16
1. Pointlist
2. Recalc.
3. Exit
  
```

Here you select function 3, Exit.

3

```

STD      10:16
ELE= xxx.xxx
Replace Z ?
  
```

This is your old station ground elevation.

Press YES (ENT) if you want to replace the old elevation with the new or press No to cancel it. In this example we press YES.

(This display will only appear if the station ground elevation has already been determined).

YES

```

STD      10:16
Store ?
  
```

Now the instrument is orientated. Do you want to store the point in an Area file answer this question with YES (ENT).

Note that the current instrument direction is stored as HA_ref.

YES

See next page

PRG

20

Store data

From previous page.

P0 10:16
Area =

Key in the name of the Area file in which you want to store the point. Then press ENT.

ENT

Sel device10:16
1. Xmem
2. Imem

In which memory unit is your Area file to be stored? In our example we are using the internal memory (Imem).

2

Pointlist ON

Note ! ←
Data that can be stored in the selected Job or Area file.

Job File		Area File	
Pno	5	Pno (Stn)	5
SH	6	N	37
Coord	37,38,(39)	E	38
Raw data	7,8,(9)	S_dev	46
Scale factor	=1 if OFF	ELE	39
Weight	=s/1 if OFF	Info: S_dev_Z	0
dHA*	45		
S_dev	46		
Info: S_dev_Z	0		
Info=Point list	0		
Pno	5		
Used raw data (Ang, Dist, Height)	0		
dN	40		
dE	41		
dELE	42		
Stn no	2		
Stn coordinates	37,38,(39)		
RefObj= Blank	62		
RefObj coordinates=0.000	37,38,(39)	* dHA=correction value of	
HA_ref	21	the calculated bearing	
HD=0	11	(orientation), which is	
IH	3	normally a low figure.	

Note ! ←
Only if Point List is on in configuration

Here are the data that can be stored in the Job or Area file you have chosen, if you have activated the point list in the configuration routine.

PRG

20

Free stn
Pointlist
OFF

From page 1.3.39

10:21
ELE = x.xxx
Replace Z?

This is your old station ground elevation.
Press YES (ENT) if you want to replace the old elevation with the new or press No to cancel it. In this example we press ENT. (This display will only appear if the ground elevation has already been determined).

YES

Store ?

Now the instrument is orientated. Do you want to store the point in an Area file answer this question with YES (ENT).
Note that the current instrument direction is stored as HA_ref.

YES

P20 10:21
Area =

Key in the name of the Area file in which you want to store the point. Then press ENT.

ENT

Sel device10:21
1. Xmem
2. Imem

In which memory unit is your Area file to be stored? In our example we are using the internal memory (Imem).

2

Note !
See next page for a list over the data that can be stored in the selected Job or Area file.

Note !

See next page

PRG

20

Store data

From previous page



Pointlist OFF

Note !

Data that can be stored in the selected Job or Area file.

Job File		Area File	
Pno	5	Pno (Stn)	5
SH	6	N	37
Coord	37,38,(39)	E	38
Raw data	7,8,(9)	S_dev	46
Scale factor	=1 if OFF 0	ELE	39
Weight	=s/1 if OFF 0	Info: S_dev_Z	0
dHA*	45		
S_dev	46		
Info: S_dev_Z	0		
Stn no	2		
Stn coordinates	37,38,(39)		
RefObj= Blank	62		
RefObj coordinates=0.000	37,38,(39)		
HA_ref	21		
HD=0	11		
IH	3		
<p>* dHA=correction value of the calculated bearing (orientation), which is normally a low figure.</p>			

Here are the data that can be stored in the Job or Area file you have chosen, if you have deactivated the point list in the configuration routine.

PRG

20

How to use - Config

How to use "Config." in Free Station

In this example, we will describe in greater detail the routine in the free station establishment program called "Config.". This option can only be accessed when starting the program with a long press on the PRG-key.

```

P20  10:15
1 Run
2 Config
    
```

Press 1 to start the program or select 2 to configurate the program. In this example we press 2. Config.

2

```

P20  10:15
1 Exit
2 Options
    
```

Press 1 Exit to return to the previous menu or press 2 options to start the configuration. In this example we press 2.

2

```

P20  10:15
Scalefactor on
on=1      off=0
    
```

Here you are given an opportunity to activate/deactivate a scale factor. The scale factor for free station establishment is calculated and defined based on the internal relation between your known points.

The following applies for the scale factor:

- Scale factor = 1.0000 if it is not activated (Off).
- If a UTM scale factor (F43) has been given, this value is multiplied by the scalefactor calculated for free station establishment.
- The scale factor that has been used is displayed after calculation of your free station (see page 1.3.40). In this example, we will activate the scale factor.

1 ENT

See next page.

PRG

20

How to use - Config

From previous page..

P20	10:15
Pointlist	on
on=1	off=0

Here you can activate/deactivate a point list. In the list you will be able to analyse and alter any deviations for each point. The deviations are displayed as "dev" (radial deviation) and "RT.ofs/Radofs" (right offset and radial offset). See Fig. 3.11 below.

1

ENT

Note !
For a more detailed explanation of how to work with the point list, see page 1.3.41.

See next page. *Geodesical*

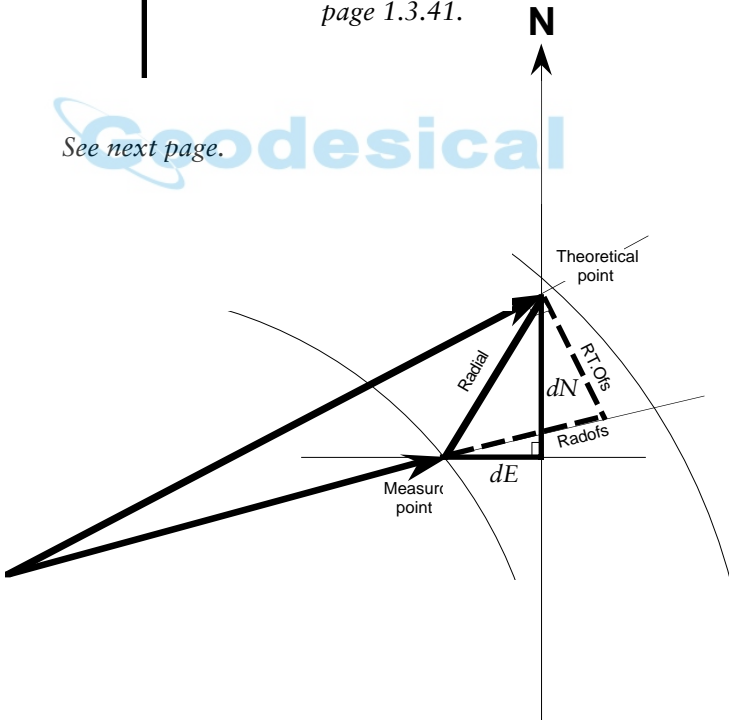

Fig. 3.11. Definition of deviations presented in the point list

PRG

20

How to use - Config

*Note ! ←
Formulas for calculating the weight factor (for the German market).*

100/S

```
P20 10:15
Weightfactor
100/s  off
on=1   off=0
```

1000/S^{3/2}

```
P20 10:15
Weightfactor
1000/s**3/2off
on=1   off=0
```

1000/S²

```
P20 10:15
Weightfactor
1000/s**2 off
on=1   off=0
```

From previous page.



```
P20 10:15
Weightfactor
s/1   on
on=1  off=0
```

By using a weight factor you can give priority to your known points with reference to distance. To put it simply, points that are further from your free station have a lower priority than the points that are closer. This function is used mostly in Germany. Normally no weight factor is used when the network is of good quality. This means that you should choose the weight factor that is defined as $s/1$.

By pressing the ENT key in steps you can produce three different bases of calculation for the weight factor (see the margin, left). These are intended mainly for Germany, and are not used otherwise. Since we will not be using this function and since weight factor $s/1$ is the default in position ON, you need press only ENT until the display shows...



```
P20 10:15
1 Exit
2 Options
```

Here you can choose to continue with your free station establishment, or repeat your configuration. If you continue with free station establishment, press 1 and then choose 1 Run to start the program. See page 1.3.33 for instructions.

 **Geodesical**

Carrying Out A Measurement

Distance & Angle Measurement _____	1.4.2
Standard Measurement (STD Mode) _____	1.4.2
Two-Face Standard Measurement (STD Mode) _____	1.4.4
Fast Standard Measurement (FSTD Mode) _____	1.4.7
Precision Measurement (D-bar Mode) _____	1.4.8
Two-Face Precision Measurement (D-bar Mode) _____	1.4.10
Two-Face Angle Measurement, Program 22 (only servo) _____	1.4.14
Collecting Detail & Tacheometry (Tracking Mode) _____	1.4.21
Setting Out (Tracking Mode) _____	1.4.24
Measuring Differences Robotic Surveying (only servo) _____	1.4.33

Illustrations

Fig. 4.1 Setting out using TRK-mode

Distance & Angle Measurement

STD

1

or

STD

Standard measurement (STD Mode)

This measurement mode is normally used during control surveys – e.g., small tacheometric exercises, survey point accuracy control, etc. Measurement time for each point takes 3.5 sec.

Geodimeter System 600 carries out the measurement and display in P0 of horizontal and vertical angles and slope distances (HA, VA & SD) with the possibility of also display horizontal distance and difference in height (HD & VD) and the northings, eastings and elevation of the point by pressing the ENT-key twice.

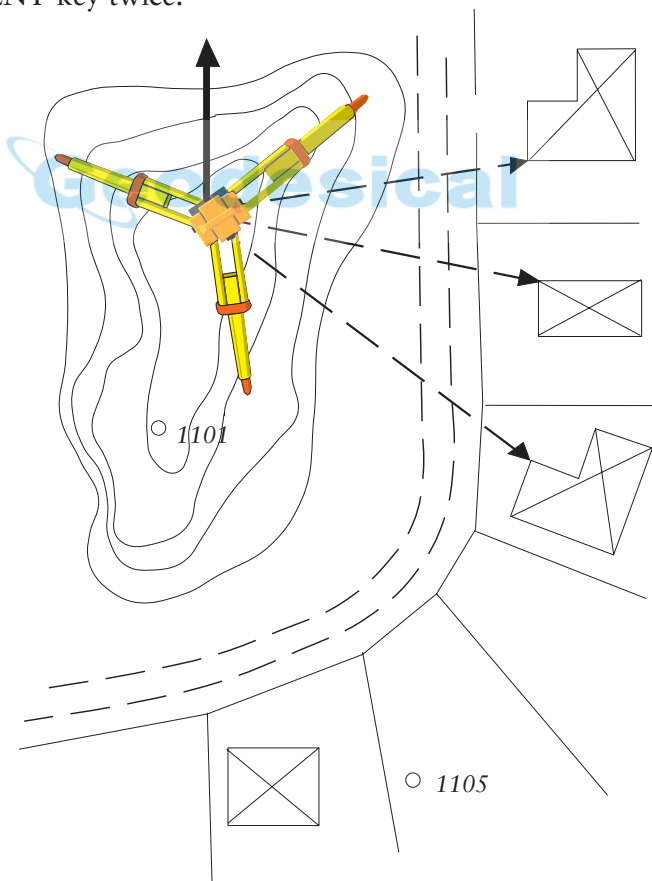

STD

1

or

STD

Note!  Power save

```

STD P0 10:17
HA: 165.2355
VA: 106.5505
    
```

Aim instrument at the point. A signal is heard if it is marked with a prism. To measure a distance press the A/M key.

A/M

Note- If you have activated Power Save you will not be able to hear a signal.

```

STD P0 10:18*
HA: 137.2235
VA: 102.2240
SD: 37.225
    
```

After 3.5 sec. the slope distance (SD) is seen on the display. If you want to see the other values – i.e. horizontal distance (HD) and vertical distance (VD), press ENT....

ENT

```

STD P0 10:18*
HA: 137.2235
HD: 37.202
VD: -1.300
    
```

If you wish to see the coords and elevation of the point, press ENT.....

ENT

The VD and ELE values are directly related to the Stn. data and IH & SH.

```

STD P0 10:18*
N: 1234.567
E: 8910.123
ELE: 456.789
    
```

To measure to the next point, aim the instrument horizontally and vertically at the prism target and repeat the above instructions. If you measure to the next point in this mode, N, E and ELE will be displayed first.

Note!  R.O.E

Note-ROE (Remote Object Elevation)

R.O.E is automatic in the display modes VD and ELE when the telescope is turned vertically. Use MNU 1.2 to preset R.O.E.

Note!  Live Data

Note-Live Data

If you turn the instrument horizontally after carrying out a measurement the values for N, E and ELE is automatically updated (within certain limits).

STD

1

or

STD

C2 + C1



Two-face standard measurement (C1/C2)

This measurement mode is normally used during control surveys – e.g., traversing, survey point accuracy control, etc. It can only be used when using the instrument as a total station (not for robotic surveying).

This mode measures and displays horizontal and vertical angles and their respective differences in C2 & C1 and slope distances with the possibility of also seeing horizontal distance, height difference and the northings and eastings by simply pressing the ENT key twice.

Two-face measurements always start in the C2 position. Distance measurement can only be carried out with the instrument in the C1 position. The asterisks (*) beside the displayed differences between C2 & C1 positions, i.e., dH & dV, indicate that face 2 and face 1 differences are in excess of $100^c (\approx 30")$. This is a good indication that it is time to carry out the instrument collimation measurement or that the instrument has been badly aimed at the target, either in C2 or the C1 position.

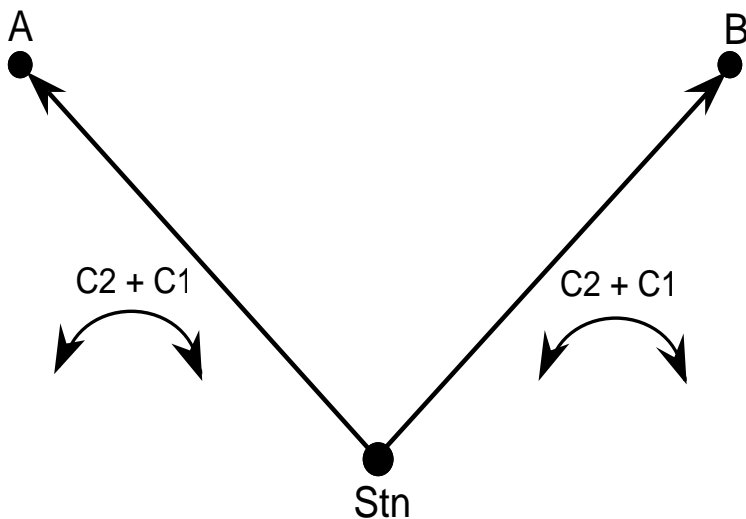

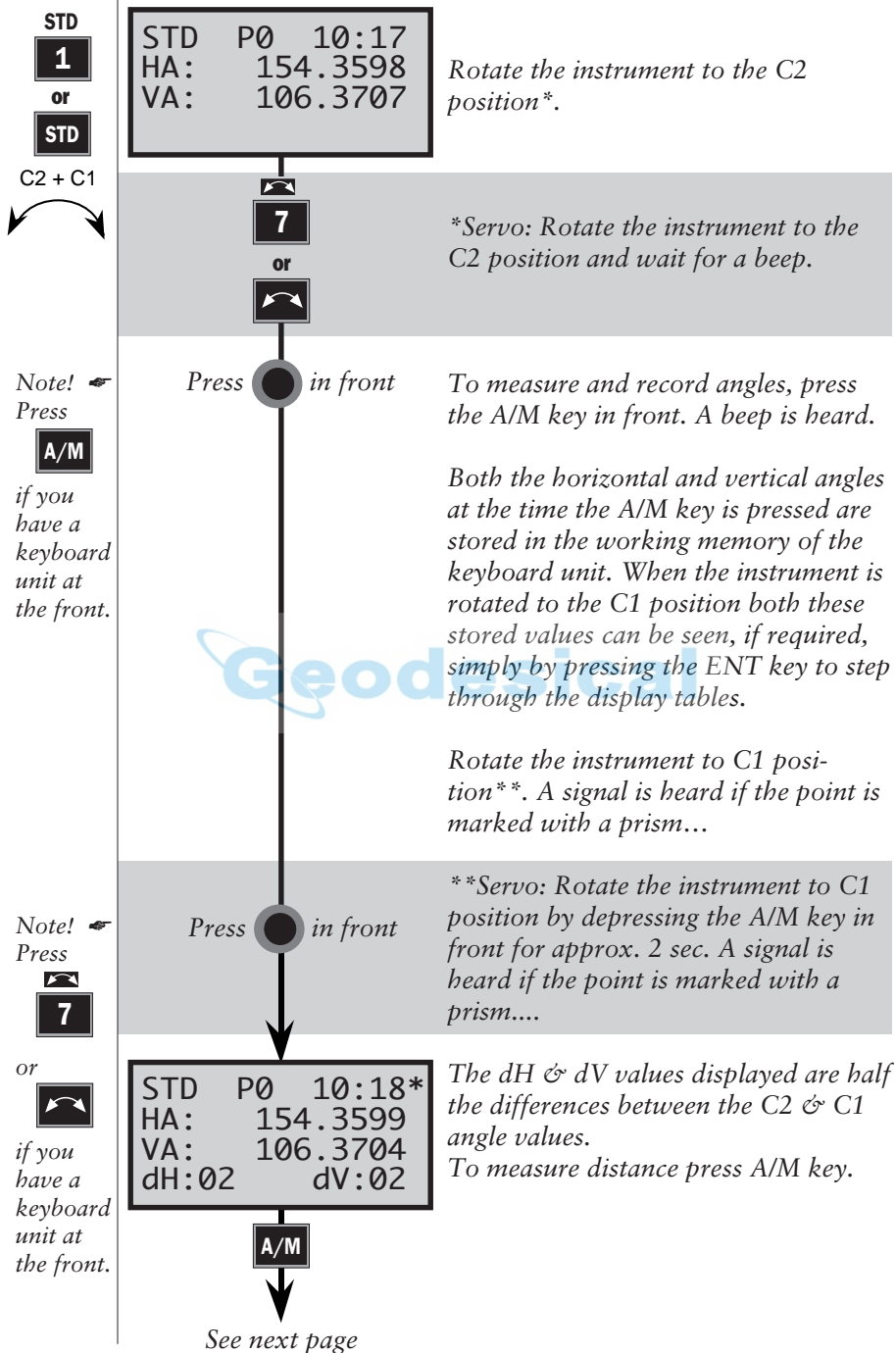

Note! Press if you have a keyboard unit at the front.

Note! Press or if you have a keyboard unit at the front.

STD
1
 or
STD
 C2 + C1

From previous page

STD P0 10:18*
 HA: 154.3599
 VA: 106.3704
 SD: 98.473

After 3.5 sec. the slope distance (SD) is seen on the display. If you want to see the other values, i.e., horizontal distance (HD) and vertical distance (VD), press ENT....

ENT

STD P0 10:18
 HA: 154.3599
 HD: 97.981
 VD: -9.836

If you wish to see the coords and elev. of the point, press ENT.....

ENT

STD P0 10:18
 N: -73.861
 E: 64.380
 ELE: -9.836

These coord & elevation values are directly related to the Stn. data and IH & SH. If you want to see the HA & VA (C2) angles, press ENT....

ENT

STD P0 10:18
 HAI: 354.3581
 VAII: 293.6284

One more press of ENT returns you to the first display and you are ready to measure to the next point. Aim the instrument horizontally and vertically at the prism target and repeat the above instructions.

Note! ➔

The R.O.E feature also operates in this two face STD measurement mode exactly the same as in the one face STD measurement mode.

Fast standard mode

In those cases when faster measurements are preferred before high accuracy, you can choose the Fast mode that speeds up the measuring time in standard mode. The measuring time will now only be approx. 1.3 sec. instead of 3.5 sec. in normal standard mode. The distance is displayed with 3 decimals as in Standard mode and with 2 decimals in Tracking mode.

The fast standard mode is indicated in the display by "FSTD".

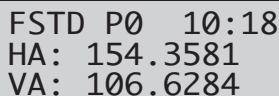

```
FSTD P0 10:18
HA: 154.3581
VA: 106.6284
```

MNU**62**

You switch between fast standard mode and normal standard mode in menu 62, Standard Measure (see chapter 1.2). The measurement procedure is identical to the standard mode, see pages 1.4.2-1.4.6.

Special function in U.D.S. (P1-P19)

When working in FSTD and U.D.S. you can measure and register with a single key press on the REG-key. You can of course measure with the A/M-key as usual and then register with the REG-key.

\bar{D}

3

or

 \bar{D} **D-bar measurement (D-bar Mode)**

This measurement mode is similar to the one face STD mode, the major difference being that distance measurement is carried out in an automatically repeated measurement cycle. The arithmetic mean value is automatically calculated, thus resulting in a greater degree of accuracy being achieved.

The instrument measures and displays horizontal and vertical angles and slope distances, you can also display horizontal distance and difference in height, and the northings, eastings and elevation of the point by pressing the ENT key twice.

The R.O.E function is similar to the one face STD mode. However, there is one major difference. The instrument must be told when distance measurement is to be stopped; this is done quite simply by pressing the A/M key. After 99 measurements the operation is stopped automatically.

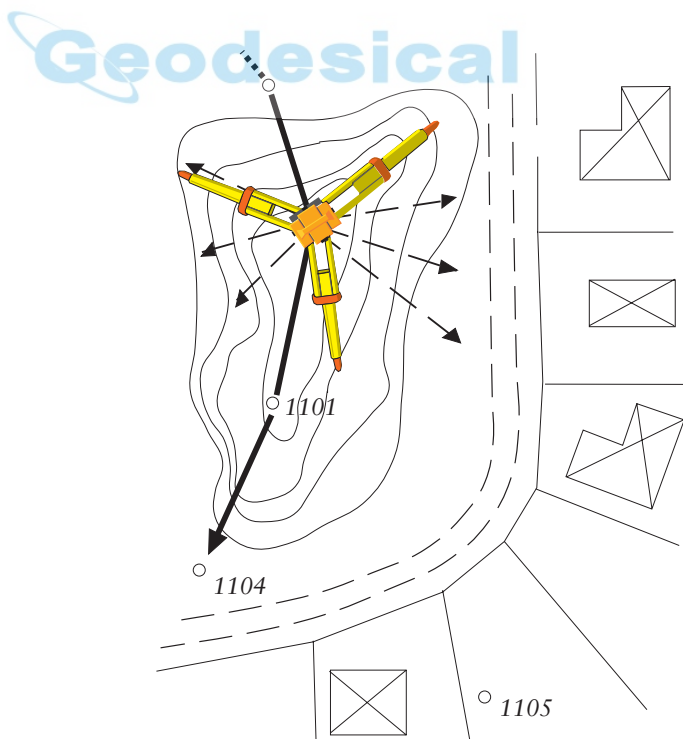

D
3
 or
D

STD P0 10:18
 HA: 399.9995
 VA: 104.8845

To assume the D-bar mode, press the D-bar key.....

D
3 or **D**

D P0 10:19
 HA: 399.9995
 VA: 104.8805

Aim towards point in the C1 position. If marked with a prism, a signal is heard. Press A/M.
 Note- If you have activated Power Save you will not be able to hear a signal.

Note! Power save

A/M

D P0 10:19*
 HA: 123.9995
 VA: 102.2205
 SD: 33.113

The distance is continuously updated. If you wish to view the calculated data of the measured point, use the ENT key to step through the different display tables, i.e to view HD & VD to point press ENT..

Note! In Hi-Res mode on GDM 640 HA and VA are shown with five decimals and SD with four.

ENT

D P0 10:20*
 HA: 123.9995
 HD: 32.363
 VD: -1.155

To view the N, E and ELE of the point.....

ENT

D P0 10:20*
 N: 5143.113
 E: 2008.156
 ELE: 187.554

If you measure to the next point with the display in this mode, N, E and ELE of the point will be displayed first.

Note!

The amount of time you allow the instrument to measure and update the distance is completely up to you. However, under normal clear visibility conditions, the distance resolution will normally stabilize after approx. 10 - 15 sec.



or



C2 + C1



D-bar two-face measurement (C1/C2)

This measurement mode is normally used during control surveys – e.g., traversing, survey point accuracy control etc. I.e. when you need high accuracy. It can only be used when using the instrument as a total station (not for robotic surveying).

The distance measurement is carried out in a repeated measurement cycle thus resulting in a greater degree of distance accuracy, and the mean horizontal and vertical angles of all measurements made in both C2 and C1 positions are automatically calculated and presented on the display.

Note! Automatic arithmetic mean value of both angles and distance

The instrument measures and displays mean horizontal and vertical angles as well as angular differences between both faces, and slope distance. You can also display horizontal distance, height difference and the northings, eastings and elevation of the point by pressing the ENT key twice. Collimation and horizontal axis tilt errors are fully compensated and operator error is minimized.

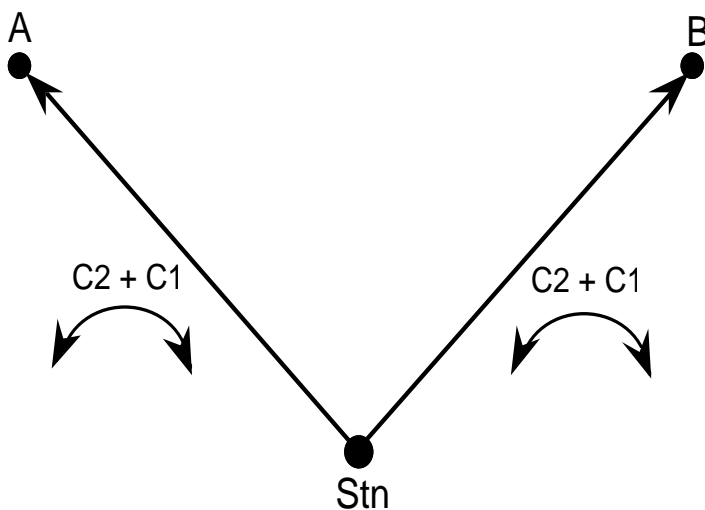

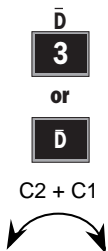

STD P0 10:17
HA: 154.3605
VA: 106.3701

To assume the D-bar mode, press the D-bar key...



D P0 10:19
HA: 154.3605
VA: 106.3701

Rotate the instrument to the C2 position*. Wait for a beep and aim at the first point.



*Servo: Rotate the instrument to the C2 position by depressing 1. Wait for a beep and aim at the first point.

Note! Press



if you have a keyboard unit at the front.

Press in front

To measure and record angles, press the A/M key in front. A beep is heard...

Both the horizontal and vertical angles at the time the A/M key was pressed were stored in the internal memory of the instrument. The number of sightings is entirely up to you, the operator, and will depend mainly on the visibility conditions and the type and required accuracy of the survey work.

Note! Press





if you have a keyboard unit at the front.

Press in front

In this example we have chosen to make two sightings in C2. Approach the point from the other direction and press A/M in front...

After pressing A/M the second time, the mean of angular C2 values is stored in the memory of the instrument. When measuring angles in this mode the same number of sightings must be made in both C2 and C1.

See next page

 **D**
 **3**
 or
 **D**
 C2 + C1

Note! Press



7



if you have a keyboard unit at the front.

Note! See General measurement hints chapter 1.6 for more info. about dH and dV.

From previous page

Press  in front

Rotate the instrument to C1 position* and aim at the point. A signal is heard if the point is marked with a prism...

*Servo: Rotate the instrument to C1 position by depressing the A/M key for approx. 2 sek. and aim at the point. A signal is heard if the point is marked with a prism...

D	P0	10:21
HA:	154.3605	
VA:	106.3701	
II:2	I:1	

Approach the point from the other direction and press A/M.



The second C1 angle measurement and indication of completion (i.e., II:2) is very quickly shown on the display...

D	P0	10:22
HA:	154.3601	
VA:	106.3731	
dH:04	dV:09	

However, the values now seen on the display are the final mean horizontal and vertical angle values of the mean of the angles measured in both faces. The dH & dV values displayed are the values by which the angles have been adjusted – i.e., half the sum of the remaining horizontal and vertical collimation and pointing errors. To measure the distance, press A/M...



D	P0	10:21*
HA:	154.3601	
VA:	106.3731	
SD:	98.472	

Distance is continually measured and updated while mean angular values are frozen. To view the HD and VD to the point, press ENT.



See next page

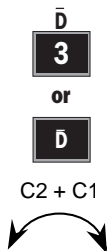

From previous page

```
D  P0  10:21*
HA: 154.3601
HD:  97.979
VD: -9.840
```

To view the N, E and ELE of the point.....

ENT

```
D  P0  10:21*
N:  -73.861
E:   64.378
ELE: -9.840
```

If you measure to the next point with the display in this mode, N, E and ELE of the point will be displayed first. If you want to see the HA & VA (C2) angles press ENT....



ENT

```
D  P0  10:21*
HAII: 354.3597
VAII: 293.6278
```

If you want to see the HA & VA (C1) angles press ENT.

ENT

```
D  P0  10:21*
HAI:  154.3605
VAI:  106.3741
```

PRG

22

C2 + C1



Two-face angle measuring, Program 22 (only servo)

When using program 22, all you need to do is to locate the targets one time in C1. When all targets are located and stored in your internal memory, you are able to select the measuring mode in which you want to work: Standard or D-bar mode. Now the instrument's servo motors will do the rest. The instrument will rotate and point directly in CII against the first registered target, you will then make the necessary fine adjustments and registrations by pressing the A/M-key in front. For rotation to CI, depress the A/M- key for a couple of seconds or .

Note that this program can only be used when using the instrument as a total station (not for robotic surveying).

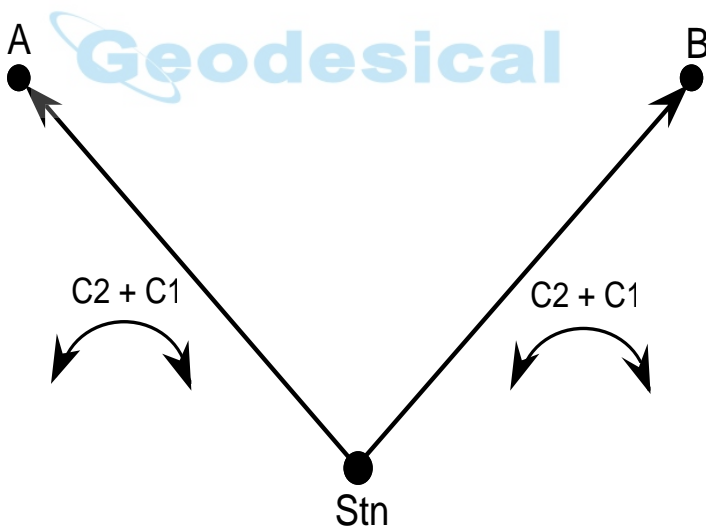

PRG

22

C2 + C1



```

STD P0  13.38
HA:   310.8390
VA:   98.1720
    
```

The Geodimeter is now in program 0 (P0). Choose program 22 - Angle Measurement.

PRG

```

P22  13.38
Job no:
    
```

The program name "2 Face Ang. Meas." is seen very briefly on the display followed by request of which Job file you want to store your angle measurements in. Key in, for example, 16.

ENT

```

P22  13.38
1:Imem off
2:Serial off
    
```

Here you select which memory device you wish to store the Job file in by choosing the appropriate number 1 or 2. In this example we will select No. 1: Imem. (2.Serial only if Imem is activated).

Note! See "Data Logging" page 2.7.1

1

ENT

```

P22  13.38
Stn=_
    
```

Key in the Stn. point name / number - e.g 1000. Press ENT.

See next page

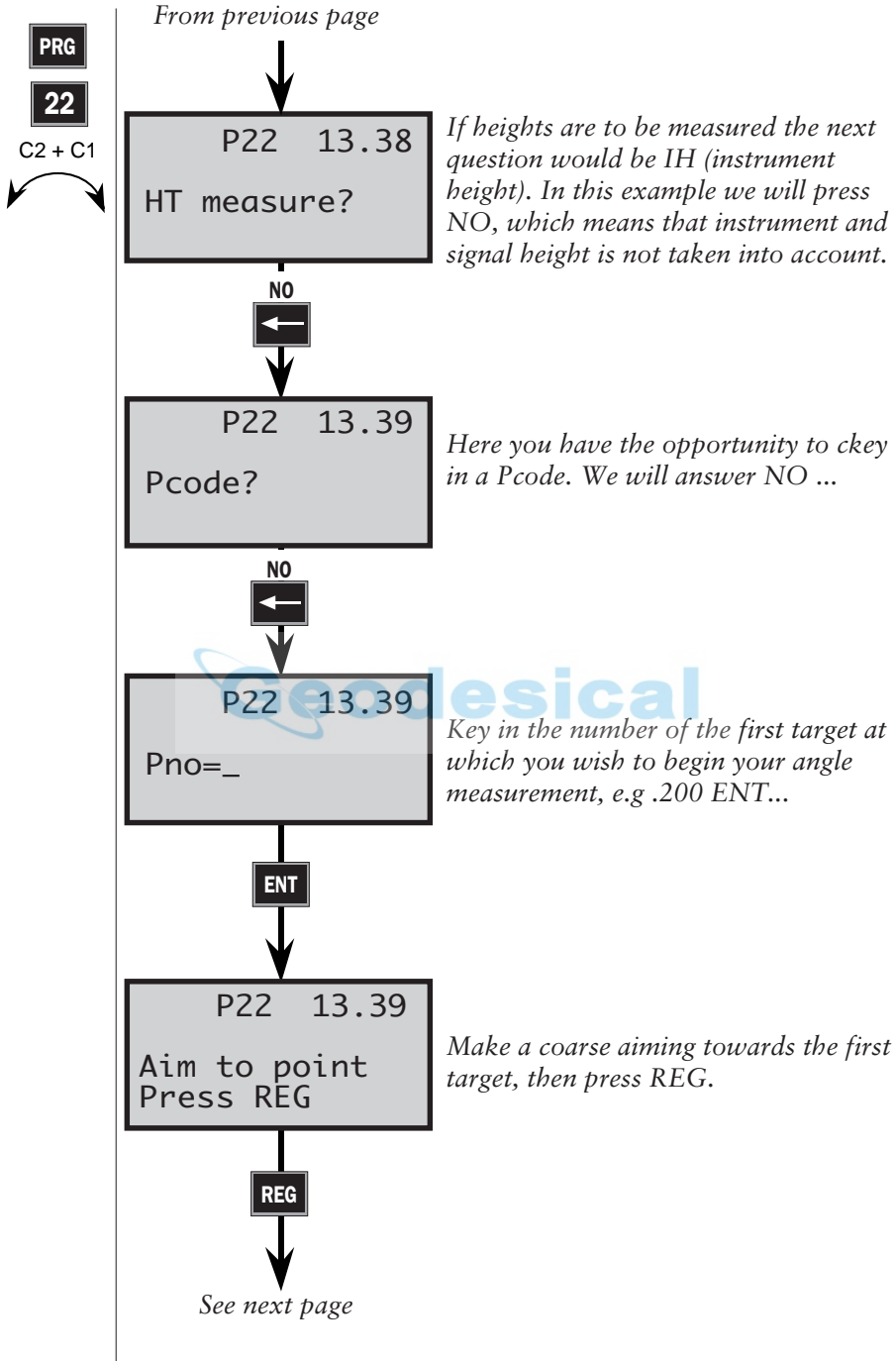

PRG

22

C2 + C1



From previous page



13.39
more ?

In this example we will continue to measure the distance to more targets. Press YES.....

ENT



P22 13.39
Pno =

Key in the second target number – e.g., 201 ENT.....

ENT



P22 13.39
Aim to point
Press REG

Make a coarse aiming towards the second target, then press REG.....

REG



See next page

PRG

22

C2 + C1



From previous page

13.39
more ?

Repeat the instructions above for your following targets. When all your targets are stored you will answer no to this question. Press NO.....

NO
←

Sel. mod 13.39
1 Std.
2 D bar.

The program gives you the opportunity to select in which measuring mode you want to work. In this example we will select No. 2= D-bar mode....

The instrument starts to rotate to C2 position, aiming at target No. 200.

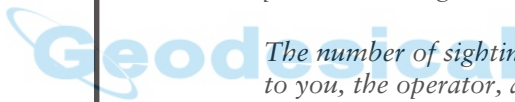

The number of sightings is entirely up to you, the operator, and will depend mainly on the visibility conditions and the type and required accuracy of the survey work. In this example we have chosen to make two sightings in C2. Approach the target from the other direction using the motion screws and press A/M...

Note! ←
Press

A/M

if you have a keyboard unit at the front.

Press ● in front

Press ● in front

After pressing A/M the second time, the mean of angular C2 values is stored in the memory of the instrument. The rule when measuring angles in this mode is that the same number of sightings must be made in both C2 and C1.

Press ● in front

Rotate the instrument to C1 position by depressing the A/M key in front for approx 2 sec.

See next page

PRG

22

C2 + C1

From previous page

```
D   P0  10:21
HA:  123.9965
HD:  102.2230
II:2          I:1
```

Approach the target from the other direction using the motion screws. Press A/M.

A/M

The second C1 angle measurement and indication of completion (i.e., II:2) is very quickly shown on the display..

```
D   P0  10:22
HA:  123.9965
HD:  102.2223
dH:05      dV:03
```

However, the values now seen on the display are the final mean horizontal and vertical angle values of the mean of the angles measured in both faces.

The dH & dV values displayed are the amounts by which the angles have been adjusted – i.e., half the sum of the re-maining horizontal and vertical collimation and pointing errors.

Now it is time to measure the distance. Press A/M....

A/M

```
D   P0  10:21*
HA:  123.9965
HD:  102.2230
SD:  33.114
```

Distance is continually measured and updated while mean angular values are frozen.

To view the HD and VD to the point, press ENT.

ENT

See next page

PRG

22

C2 + C1

From previous page

```

D   P0  10:21*
HA:  123.9965
HD:   33.095
VD:  -1.155
    
```

To view the N, E and ELE of the point press ENT.

ENT

```

D   P0  10:21*
N:  5188.555
E:  2148.186
ELE: 397.851
    
```



To continue, press the REG key and the instrument will aim at the next target in C2 position. Repeat the instructions above.

Note! ➔

Note !

After the last point you are prompted "Repeat ?"

If answering Yes to this question, all points will be remeasured.

TRK

2

or

TRK

Collecting detail & Tacheometry (TRK-Mode)

This measurement mode is normally used during both large and small topographic exercises. The TRK mode is fully automatic. All measured values will be updated 0.4 sec. after making contact with the prism. No keys have to be pressed between measurements. It is worth pointing out that battery power consumption is a little higher in this measurement mode compared to the execution of tacheometry in STD mode. R.O.E is automatic in this measurement mode.

Note that as measurements are started automatically, there is a slight risk that measurements are made when the instrument is badly pointed towards the prism. We recommend using Fast Standard measurements (FSTD) when short measuring time is required.

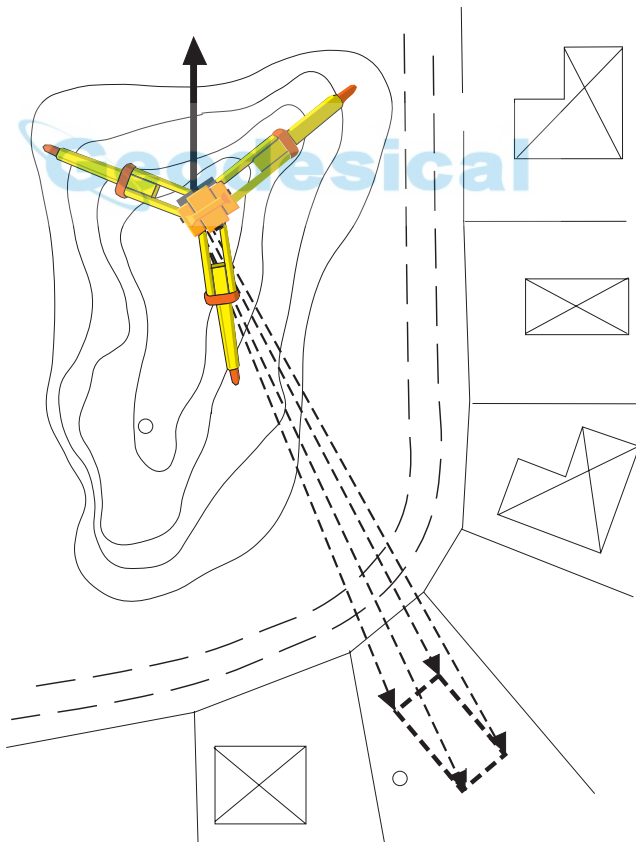

TRK
2
or
TRK

STD P0 10:17
HA: 165.2355
VA: 106.5505

To engage tracking mode, press TRK key.....

TRK
2 or TRK

TRK P0 10:17
HA: 165.2355
VA: 106.5505

Aim towards the point. Distance measurement starts automatically and there is no need to press A/M.

TRK P0 10:17*
HA: 159.8700
HD: 104.36
VD: -8.508

HD & VD appear on the display. To view coords. and height of point, press ENT.....

ENT

TRK P0 10:17*
N: 1234.567
E: 9101.112
ELE: 31.415

To view HA, VA & SD to the point, press ENT.....

ENT

TRK P0 10:17*
HA: 159.8710
VA: 105.1785
SD: 104.71

If you measure to the next point with the display in this mode, N, E and ELE of the point will be displayed first.

Note! ↗

R.O.E is automatic in the display modes VD & ELE when the telescope is turned vertically.

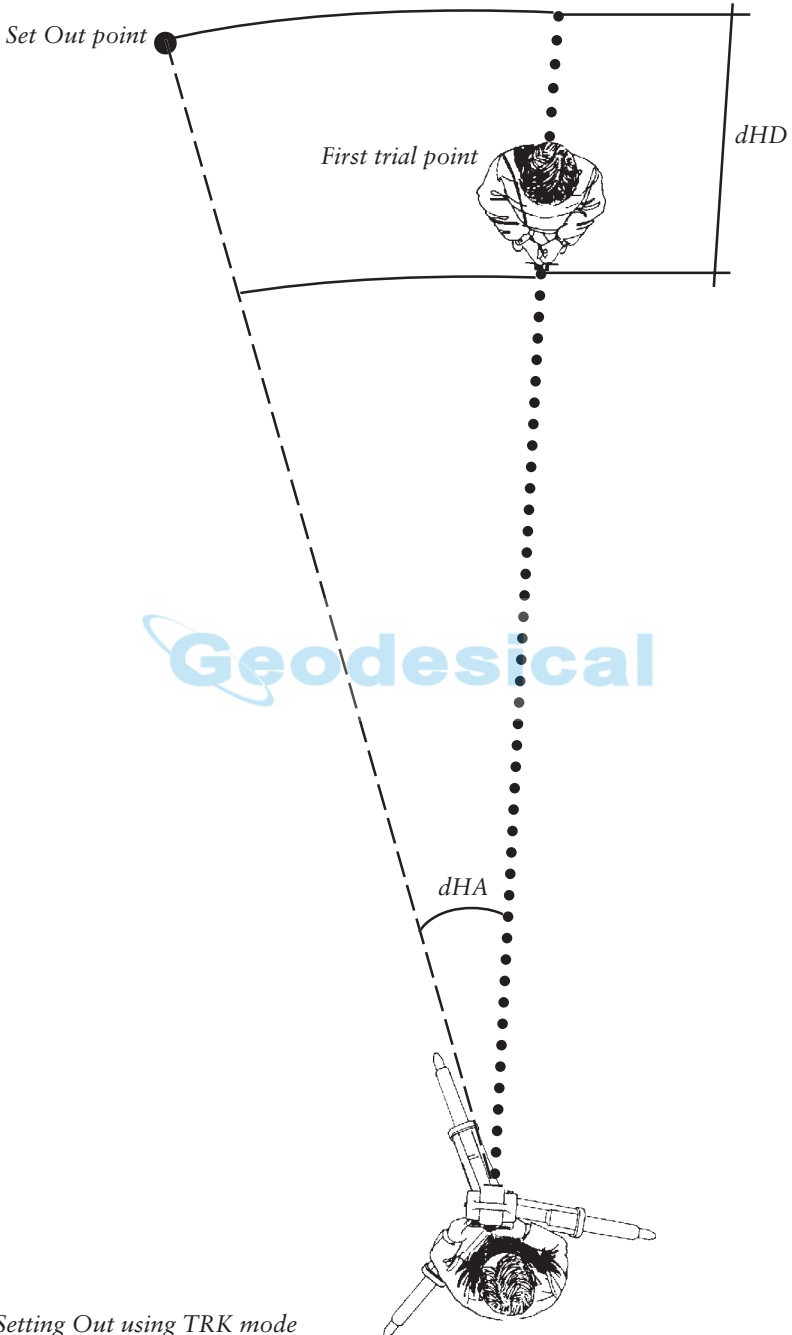

Fig 4.1 Setting Out using TRK mode

TRK

2

or

TRK

Setting Out (TRK Mode)

The tracking measurement mode is mainly intended for setting out, with the option of using countdown to zero of both the horizontal bearing (azimuth), distance and height to the setting out point. This is achieved by using the inherent intelligence of the instrument – i.e., the instrument very quickly calculates the difference between the present direction and the required direction to the point to be set out, and the difference between the horizontal distance measured and the required distance to the point. These differences are visible on the display. When both the dHA (difference in horizontal angle) and dHD (difference in horizontal distance) = 0, the range rod is then being positioned over the setting out point.

The setting out routine can be carried out in two different ways. One way is to key in the SHA (setting out bearing), SHD (setting out horizontal distance) and SHT (setting out height) values. This is done after first calling up F27, F28 and F29 respectively. The point height is set out using the R.O.E feature.

The other way is to carry out setting out calculations using the main menu, Option 3: Coord, choices 1 & 2 – i.e., keying in the instrument station data (including instrument height = IH), and set out point data. The instrument will then calculate the bearing = SHA and horizontal distance = SHD between the instrument station point and each individual setting out point. If elevation is keyed in the SHT will also be calculated. After setting out the point and checking the point coordinates and elevation, you re-enter the main menu: Option 3, choice 2 and key in the coords and elevation of the next set out point.

The following pages will give examples of setting out, first in the normal way (keying in SHA, SHD and SHT) and then by using the main menu: Option 3, choices 1 & 2.

TRK

2

or

TRK

Setting Out using pre-calc. bearings & horizontal distances SHA & SHD

STD P0 10:17
HA: 33.7965
VA: 109.3960

To engage tracking mode, press the TRK- key.

TRK

2

or

TRK

TRK P0 10:17*
HA: 33.7965
VA: 109.3960

To key in setting out bearing, press F27 (F27 = SHA).

Note! ←
F27 = SHA

F

27

TRK P0 10:17*
SHA=88.9515

Key in the bearing to setting out point for example, 88.9515, then ENT.

ENT

TRK P0 10:17*
HA: 33.7965
dHA: 55.1550

To key in horizontal distance to setting out point press F28 (F28=SHD).

Note! ←
F28= SHD

F

28

See next page

TRK
2

or
TRK

From previous page

TRK P0 10:17*
SHD=104.324

Key in horizontal distance to setting out point, for example 104.324 and press ENT.

Note! Height Setting Out

ENT

If you wish to carry out 3 dimensional point setting out, key in the setting out height with F29 = SHT.

TRK P0 10:17*
HA: 33.7965
dHA: 55.1550

HA and dHA appear. Rotate instrument* until it displays approx. 0.0000 opposite dHA - i.e., it is pointing in the direction of the first setting out point. HA is the calculated bearing to the set out point. No sign before dHA means the instrument must be turned to the right.

Note! When using the RPU, use the CL-key to position the instrument

or 8

*Servo: When positioning in the horizontal direction press this key and wait for a beep.

or 9

*Servo: When positioning in the vertical direction, if SHT has been keyed in, press this key.

or 6

*Servo: When positioning in both horizontal and vertical direction, press this key.

Note! Tracklight



This is where Tracklight can be used to its advantage, by directing the prism holder so that he/she is in line for the first setting out point and able to follow the Tracklight.

TRK P0 10:17*
HA: 88.9515
dHA: 0.0000
dHD: -7.25

As soon as the prism comes within the measurement beam you will see dHD (minus sign before dHD means the prism must be moved towards the instrument). Continue this procedure until both the dHA and dHD = 0. The correct keyed in bearing (azimuth) of 88.9515 will also appear opposite HA in the display. The correct position of the point has now been set out.

See next page

TRK
2
or
TRK

Note! 
F29 = SHT

From previous page

F
29

Height setting out can be carried out by keying in F 29 SHT.

TRK P0 10:17*
SHT=45.363

We assume that the elevation has been keyed in using MENU 31 and IH using F3. Signal height (F6) can be set to 0 when using R.O.E. This means that the crosshair will point towards the correct elevation

ENT

TRK P0 10:17*
dHA: 0.0000
dHD: 0.0000
dHT: 1.236

Turn the telescope vertically until 0 is obtained on SHT..

TRK P0 10:17*
dHA: 0.0000
dHD: 0.0000
dHT: 0.000

To view the N, E and ELE, press ENT..

ENT

TRK P0 10:17*
N: 203.99
E: 100.24
ELE: 45.363

To continue, aim at the next point and follow the above instructions.

See the following pages for setting out when using instrument station data and set out point data.

TRK

2

or

TRK

Setting Out using coordinates

TRK P0 16:45
HA: 66.4565
VA: 101.2345

After having gone through the start procedure, enter the main menu by pressing MNU...

MNU

Menu 16:45
1.Set
2.Editor
3.Coord

Choose option No. 3...

3

Coord 16:45
1.Stn Coord
2.Setout coord
3.Fetch Stn data

Choose option No. 1 (instrument station data).

1

Coord 16:46
N = 0.000

Key in "N" (coordinate value of instrument station point) and press ENT.

ENT

See next page

TRK
2
or
TRK

From previous page

Coord 16:46
N = 123456.789
E = 0.000

Key in "E" coordinate value of instrument station point. Press ENT...

ENT

Coord 16:46
N = 123456.789
E = 455678.910
ELE = 45.355

Key in height value of instrument station point. Press ENT...

ENT

TRK P0 16:47
HA: 66.4565
VA: 101.2345

All three values are now stored in the instrument's memory. Now use the functions F3 and F6 to key in instrument height (IH) and setting out reflector height (SH). Then press MNU.

MNU

See next page

Note! 
R.O.E

Note !

It is recommended that the setting out point SH be set to zero if you wish to carry out 3 dimensional point setting out. This means that the actual height of the object which is being set out (e.g finished road level centre line point, top of concrete pour etc. etc.), can be marked directly on the marker pole or concrete shuttering, exactly at the point at which the centre of the reticle (horizontal crosshair) is pointing.

TRK

2

or

TRK

From previous page

Menu 16:48
1.Set
2.Editor
3.Coord

Press option No. 3.....

3

Coord 16:48
1.Stn Coord
2.Setout coord.
3.Fetch Stn data

Choose option No. 2 (Set out point data)

Note !

If the orientated bearing isn't available, you may key in the Ref.Obj as the first SetOut coord. The bearing towards the Ref.Obj will then be calculated and can be found under function 27 (F 27). Make a note of it and use it when setting the orientated bearing.

Note! →

2

Coord 16:48
SON=0.000

Key in "N" coordinate value of set out point. Press ENT.

ENT

Coord 16:49
SON=123556.789
SOE=0.000

Key in "E" coordinate value of set out point. Press ENT.

ENT

See next page

TRK

2

or

TRK

See previous page

```

Coord  16:49
SON=123556.789
SOE=455778.910
SHT=40.500

```

Key in height value of set out point. Press ENT.

ENT

```

TRK  P0  16:49
HA:   66.4565
VA:  101.2345

```

Aim the instrument at the Ref. Object and key in the orientated bearing* using F21, then press ENT..

*see note on previous page.

ENT

```

TRK  P0  16:50
HA:   29.5070
dHA:  20.4930

```

When HA and dHA appear, rotate the instrument* until it displays approx. 0.0000 opposite dHA – i.e., it is pointing in the direction of the first setting out point. HA is the calculated bearing to the set out point. No sign before dHA means the instrument must be turned to the left.

Note!  When using the RPU, use the CL-key to position the instrument

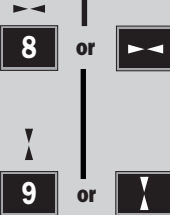

*Servo: When positioning in the horizontal direction press this key and wait for a beep.

*Servo: When positioning in the vertical direction, if carrying out 3 dimensional setting out, press this key.

Note!  Tracklight



See next page

This is where Tracklight can be used to its advantage, by directing the prism holder so that he/she is in line for the first setting out point and able to follow the Tracklight.

TRK

2

or

TRK

From previous page

```

TRK P0 16.51*
HA:    50.000
dHA:   0.0000
dHD:   2.03
    
```

As soon as the prism comes within the measurement beam you will see dHD (minus sign before dHD means the prism must be moved towards the instrument).

Continue this procedure until both the dHA and dHD = 0. The correct keyed in bearing (azimuth) of 50.000 will also appear opposite HA in the display. The correct position of the point has now been set out.

By pressing the ENT key at this stage you can check the accuracy of the set out point by checking the HD, VD, N, E and Elevation.

ENT

```

TRK P0 16:52*
HA:    50.0000
HD:    141.142
VD:    0.000
    
```

50.0000 is the correct bearing to the point and 141.42 is the correct distance. Now for the Height, press ENT.

ENT

```

TRK P0 16:52*
N:    123556.78
E:    455778.91
ELE:  40.500
    
```

Elevation of the point to be set out is 40.500. Turn telescope upwards until it shows this value.

You are now ready to set out the next point. Press MNU, choose Option 3, choice No. 2, SetOut Coord and repeat the above instructions.

Measuring Differences Robotic Surveying (only servo)

Important information when measuring with high accuracy and using the instrument's Tracker

To achieve the highest accuracy when measuring distances shorter than 200 meters and using the Tracker unit you need to be aware of the following:

If you use a large reflector like the Super Prism (Part no. 571 125 021), reflections from the Tracker unit may have influence on the measured distance. The error can vary from 0 to 3 mm. If you use the Miniature Prism (Part no. 571 126 060) this error doesn't occur.

STD-mode measurement

When carrying out a STD-mode measurement in robotic surveying the measurement procedure is a little bit different from the totalstation; when pressing the A/M-key for a measurement the servo is first fine adjusting the instrument towards the target, the RMT. After that the measurement is initiated. The distance measurement is made during about 4 sec. Under that time the arithmetic mean value of a large number of angle measurements is also calculated and presented thus eliminating an effect of any instability of the RMT during the measurement and resulting in higher accuracy.

D-mode measurement

When carrying out a D-mode measurement in robotic surveying the servo is first fine adjusting the instrument towards the target. Each single measurement of distance and angles is made in the same way as in STD-mode measurement and a continuously updated arithmetic mean value of the repeated measurement for both angles and distance are calculated. This is an improvement compared with the servo-assisted surveying where only the arithmetic value for distance is calculated.

TRK

2

or

TRK

TRK-mode measurement

When carrying out measurements in TRK-mode the servo is set to follow the moving target and very fast measurements can be carried out, but then without fine adjusting the instrument towards the target before the measurement is carried out. TRK-mode is designed to be used for fast measurements when e.g. setting out. Whenever higher accuracy is demanded the operator can easily switch between the different measurement modes.



Surveying methods

In general _____	1.5.2
Conventional surveying with servo _____	1.5.2
Autolock™ (only servo) _____	1.5.3
Remote Surveying _____	1.5.3
Robotic Surveying (only servo) _____	1.5.3
Conventional Surveying with Autolock™ (only servo) _____	1.5.4
Important information when measuring with high accuracy—	1.5.4
How to work with Autolock™ _____	1.5.5
Aiming _____	1.5.6
Remote Surveying _____	1.5.7
Important information when measuring with high accuracy—	1.5.7
How to work with remote surveying _____	1.5.8
Activation of the RPU _____	1.5.10
Aim, Measure, Register _____	1.5.11
Robotic Surveying (only servo) _____	1.5.12
Important information when measuring with high accuracy—	1.5.12
How to work with robotic surveying _____	1.5.13
Search window _____	1.5.15
Activation of the RPU _____	1.5.16
Aim & Measure _____	1.5.17
Establishing contact from a detached control unit _____	1.5.18
Switch to measurement towards an ordinary prism _____	1.5.19
Switch back to robotic surveying _____	1.5.20
Search functions in robotic surveying _____	1.5.21
Eccentric Point _____	1.5.23
The RPU Menu _____	1.5.25
Illustrations _____	
Fig. 5.1 Set window _____	1.5.14
Fig. 5.2 Eccentric point _____	1.5.24

In general

This chapter will describe the different ways of working with Geodimeter System 600. First of all you can work conventionally with the system. Since the instrument is equipped with servo drive, you'll find that the system is very easy to handle, when setting out you can with a touch of a single key aim the instrument towards the set out point.

Conventional surveying with servo

If your instrument is equipped with servo drive, this means a lot of advantages:

- In e.g. setting out you only need to give the point number. The instrument will calculate and aim automatically towards the precalculated bearing with a single press of the positioning key .
- For angle measurements, just aim towards the different reflector stations once. The instrument remembers and repeats the aiming process however many times and in whatever order you want.
- During manual aiming, the servo assists the horizontal and vertical adjustments. All that's needed is a light circular movement of the adjustment screw with your finger tip.
- Thanks to servo-drive, adjustments screws have no end positions. That means no unnecessary interruptions, when aiming.

Autolock™ (only servo)

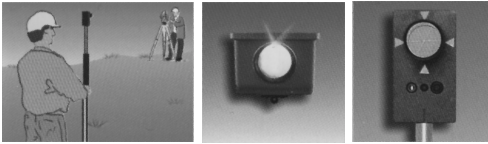

Secondly you can equip your instrument with a tracker unit and take full advantage of the feature we call Autolock™, this enables the instrument to lock on to a RMT and automatically follow it as it moves. This means that there is no need for fine adjustment or focusing.

Remote Surveying

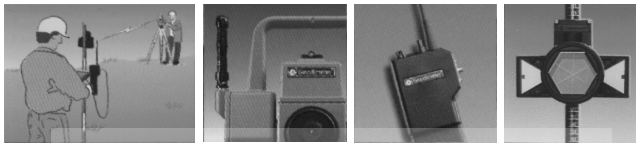

With an instrument, a telemetric link and an ordinary prism you can work with remote surveying which enables you to have the control over the measured data from the point.

Robotic Surveying (only servo)

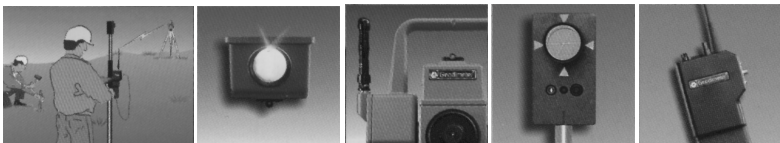

With both a tracker unit and a telemetric link you can work with robotic surveying. This means that you can take over the control of the whole measurement from the point, i.e. you have a one-person system. On the following pages we will describe the different measuring techniques with Geodimeter System 600.

Conventional surveying with Autolock™ (only servo) —

With the feature Autolock™, you do no longer have to fine adjust or focus, since this is taken care of by the system.

- To upgrade a base unit to Autolock™, you'll only need to add a Tracker unit and a RMT target. It is also possible to measure in a conventional way without Autolock™ using an ordinary reflector.
- When setting out, you'll only need to supply a pre-stored point and the system will calculate the necessary data for setting out. Then, position the instrument with the positioning key. When the rodman, guided by the built-in Tracklight enters the Tracker's field of view (2.5m/100m), the instrument locks onto the RMT automatically. You're now able to fully concentrate on the information in the display (radial/right angle offset) and direct the rodman to the setting out point.

Important information when measuring with high accuracy (and using the instrument's Tracker)

To achieve the highest accuracy when measuring distances shorter than 200 meters and using the Tracker unit you need to be aware of the following:

Always use the Miniature Prism (Part no. 571 126 060) mounted on your RMT. If you use a large reflector like the Super Prism (Part no. 571 125 021), reflections from the Tracker unit may have influence on the measured distance. The error can vary from 0 to 3 mm. This error doesn't occur using the Miniature Prism.

*Conventional
Surveying
with
Autolock*

How to work with Autolock™

First switch on your instrument and make the necessary setup; activate compensator, enter PPM-parameters etc.

```
STD PO 16:12
HA: 72.0000
YA: 90.0000
```

First press the "RPU"-button on the instrument.

RPU
4 or RPU
↑

```
RPU 16:12
1 Autolock ←-
2 Manual
```

Choose 1. Autolock.

1

OPTIONAL

```
Autolock 16:12
1 OK
2 Window control
3 Search control
```

Press 1. to switch on the Autolock function. This display does only appear if you installed the search option.

1

The instrument is now setup for Autolock™. A search function can be added as an option. With this option both sector control and search control can be used. For more information, see chapter 2.5.

Measuring towards an ordinary prism

If you aim towards an ordinary prism with the Autolock™ option on and press the A/M-key, you will be prompted: "Measure OK?". Press YES to proceed the measurement or press NO to cancel it. If you choose to measure and press the REG-key, you will be prompted: "Reg OK?". Press YES to registrate the measurement or press NO to cancel it.

*Conventional
Surveying
with
Autolock*

Aiming

The adjustment between the two optical axes, i.e. the Telescope and the Tracker, may differ. The difference will make it seem like the instrument does not point towards the centre of the prism, when using Autolock™ (see fig. below). This is not a problem since the two axis have their own collimation data. It is however important to make collimation test for both axis.

*Without Autolock
Manual aiming*

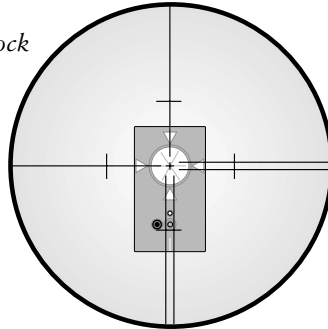

With Autolock

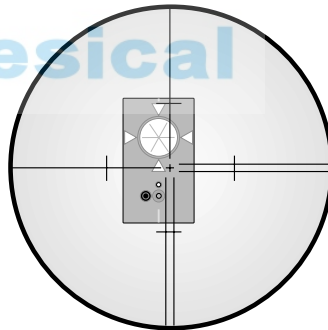

How to check

You can check how good the instrument is calibrated yourself, by measuring towards the same prism with and without Autolock™ and compare the displayed angles:

- Without Autolock™: The instrument shows the angles for the tube.
- With Autolock™: The instrument shows the angles for the tracker.

If the angle deviations are large you should calibrate both the tube (MNU 5.1) and the tracker (MNU 5.3), see chapter 1.2.

Remote Surveying

Remote surveying means the instrument operator's job is to aim the instrument toward the reflector. The most experienced member of the survey crew is out at the measuring point taking care of the qualified work of checking, coding, registering etc.

Remote surveying gives you the ability to access the information where it's most needed. Because it's out at the measuring point itself you most often discover how to achieve the best results.

Important information when measuring with high accuracy

To achieve the highest accuracy when measuring distances shorter than 200 meters and having the Tracker unit installed on your instrument you need to be aware of the following:

If you use a large reflector like the Super Prism (Part no. 571 125 021) or the Tilttable Reflector (Part No. 571 126 110) you need to cover the tracker aperture before you measure the distance. Otherwise reflections from the Tracker unit may have influence on the measured distance. The error can vary from 0 to 3 mm. If you use a Miniature Prism (Part no. 571 126 060 or 571 126 100) this error doesn't occur.

Equipment

To be able to work with remote surveying you'll need a control unit at the point. You will also need to equip your instrument with a radio side cover (see chapter 1.1) and to connect an external radio to the RPU. The control unit, the prism and the external radio will hereafter be called, RPU.

Radio communication

In order for the instrument and the RPU to be able to communicate you will have to set the same radio channel at the instrument and at the RPU. Select a channel with regard to other radio systems that might be in operation in your immediate area. If radio disturbances occur, e.g. if Info 103 is displayed, try another channel.

Remote Surveying

How to work with remote surveying

First turn on your instrument and make the necessary setup; activate compensator, enter PPM-parameters, etc. Then select radio channel in MNU1.5. In the following examples we will use a larger display appearance for the RPU.

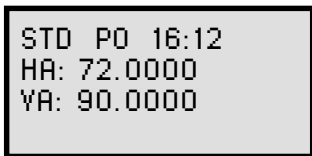

First press the "RPU"-button on the instrument.

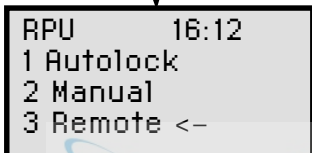
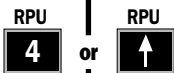

To be able to work with robotic surveying, press 3 Remote.

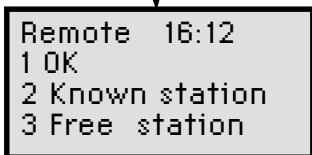

Now choose method of station establishment: 1 OK, 2 Known Station, 3 Free Station or 4 Known Station+. In this case we choose 1 OK.



See next page

Note ! ↗ Station Establishment, see chapter 1.3 for more information.

Note-Station Establishment

Station Establishment is described in chapter 1.3.

If you don't want to use the station coordinates according to 2 Known station, 3 Free station or 4 Known Station+ you can choose 1 OK. In this case the horizontal angle (HAref) that was set in the station unit will be used.

Note ! Define window is described further on page 1.5.14.

```
Remote 16:12
Define window?
```

To define a search window press YES/ENT.

ENT

```
Remote 16:12
Aim to A
Press ENT
```

Aim to the upper/lower left boundary and press ENT.

ENT

```
Remote 16:12
Aim to B
Press ENT
```

Aim to the upper/lower right boundary and press ENT.

Note ! Define window

Note - Define window
The window can be relocated from the RPU menu, see chapter 2.5.

ENT

```
Remote 16:12
Measure Ref obj?
```

Do you want a reference object ? If so, press YES or ENT, otherwise press NO. The reference object doesn't have to be located at a known point, but should be located outside the search window where the sight is clear.

Note ! The reference object must be a remote target (RMT).

ENT

```
Remote 16:12
Aim at refobj.
Press ENT
```

Aim at the Reference Object (RMT) and press ENT.

ENT

See next page

*Remote
Surveying*

```
Remote 16:12
Press any key
Remove keyboard
```

Now it is time to take control over the measurement from the RPU, that is the detached keyboard unit at the measuring point. Press any key and detach the keyboard unit from the station unit.

Activation of the RPU

PWR

Activate the RPU by pressing the PWR-key.

```
16:13
Comp init
Please Wait
```

The compensator in the instrument is now calibrating, please wait.

Geodesical

```
16:13
Temp=
```

When the calibration is ready you will step to program 0, where you enter the PPM values, temp, pressure, offset and HAref.

ENT

```
STD  P0 16:13 Am
HA:  192.8230
VA:  91.7880
```

The display now switches to Standard Measurement mode. You are now in control over the measurement from the RPU. In the upper right display corner you can see the battery status of the battery connected to the station unit and the function of the A/M-key (see chapter 2.5).

See next page

Remote
Surveying

Aim, Measure, Register

From previous page

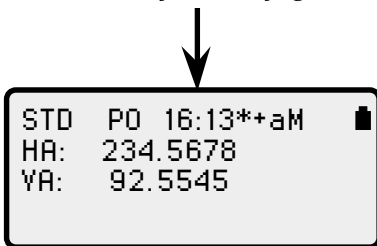

*When the station unit operator has aimed towards the prism, the RPU is ready to take a measurement. This is indicated with a *. Press the A/M key to start measuring.*

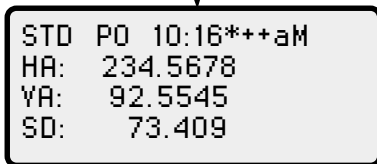

The display will show Horizontal angle (HA), Vertical Angle (VA) and Slope Distance (SD).



Robotic Surveying (only servo)

The robotics of the system are unique. By equipping the instrument with a tracker unit, even aiming can be done from the measuring point. The entire measurement is performed from the point, with the same access to all functions of the totalstation as if you were standing beside it.

Robotic surveying means higher production capacity. During setting-out, it's best with two people: one to handle the measuring with the RPU, and one to mark the points. Of course, the entire job can be performed by a single person. The unique search function makes robotic surveying extremely efficient 24 hours a day.

Important information when measuring with high accuracy (and using the instrument's Tracker)

To achieve the highest accuracy when measuring distances shorter than 200 meters and using the Tracker unit you need to be aware of the following:

If you use a large reflector like the Super Prism (Part no. 571 125 021) on your RMT, reflections from the Tracker unit may have influence on the measured distance. The error can vary from 0 to 3 mm. If you use the Miniature Prism (Part no. 571 126 060) instead this error doesn't occur.

Equipment

To be able to work with robotic surveying you'll only need one control unit, which you after station establishment etc. disconnect from the instrument and bring to the point. You will also need to equip your instrument with a radio side cover (see chapter 1.1), a tracker unit, a RMT (Remote Target) and an external radio connected to the keyboard unit. The keyboard unit, the RMT and the external radio will hereafter be called, RPU.

Radio communication

In order for the instrument and the RPU to be able to communicate you will have to set the same radio channel at the instrument and at the RPU. Select a channel with regards to other radio systems that might be in operation in your immediate area. If radio disturbances occur, e.g. if Info 103 is displayed, try another channel.

*Robotic
Surveying*

How to work with robotic surveying

First turn on your instrument and make the necessary setup; activate compensator, enter PPM-parameters, perform station establishment etc. Then select radio channel in MNU1.5. In the following examples we will use a larger display appearance for the RPU.

```
STD PD 16:12
HA: 72.0000
YA: 90.0000
```

First press the "RPU"-button on the instrument.

RPU RPU
4 or ↑

```
RPU 16:12
1 Autolock
2 Manual ←-
3 Remote
```

Choose 3 Remote for robotic surveying.

3

```
Remote 16:12
1 OK
2 Known station
3 Free station
```

Now choose method of station establishment. In this case we choose 1 OK=No station establishment.

1

See page 1.5.15

*Note ! ↗
Station
Establishment, see
chapter 1.3
for more
information.*

Note-Station Establishment

Station Establishment is described in chapter 1.3. If you don't want to use the station coordinates according to 2 Known station, 3 Free station or 4 Known Station+ you can choose 1 OK. In this case the horizontal angle (HAref) that was set in the station unit will be used.

*Robotic
Surveying*

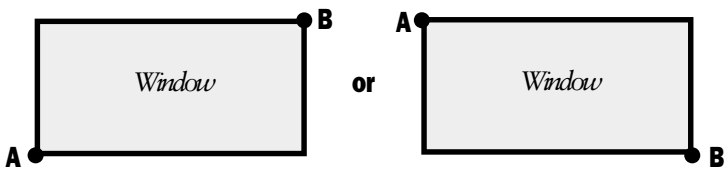
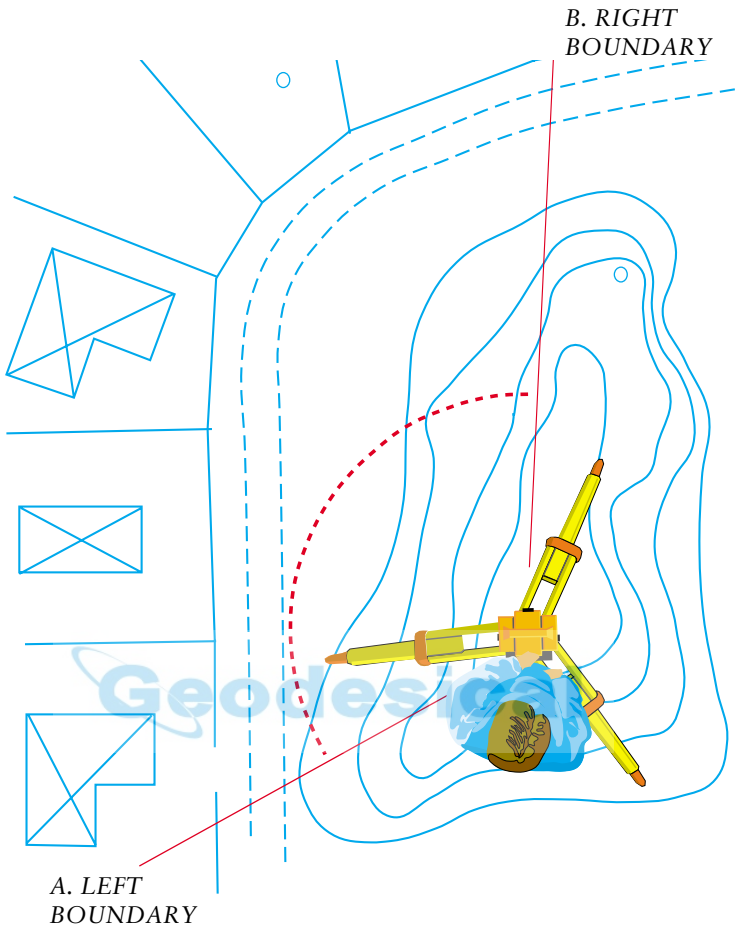

*Fig 5.1 Set window
The sector window can be defined as described above.*

Robotic
Surveying

Search window

From page 1.5.13

When Station Establishment has been carried out or 1.OK is selected the display will show "Define window?". Define window gives you the possibility to set a window in which the instrument will search for the RPU. This will decrease the search time and will make you more efficient (it takes 10-12 sec for the instrument to search the complete circle). In this example we will show you how to use the function, answer YES.

Remote 16:12
Define window?

YES

Aim to the upper/lower left boundary and press ENT.

Remote 16:12
Aim to A
Press ENT

ENT

Aim to the upper/lower right boundary and press ENT.

Remote 16:12
Aim to B
Press ENT

ENT

Note - Define window
The window can be relocated from the RPU menu, see chapter 2.5.

Note ! Define window

Remote 16:12
Measure Ref Obj?

Do you want a reference object ? If so, press YES or ENT, otherwise press NO. The reference object doesn't have to be located at a known point, but should be located outside the search window where the sight is clear.

Note ! The reference object must be a remote target (RMT).

ENT

Remote 16:12
Press any key
Remove keyboard

Now it is time to take control over the measurement from the RPU, that is the detached keyboard unit at the measuring point. Press any key and detach the keyboard unit from the station unit.

ENT

See next page

Activation of the RPU

PWR

Activate the RPU by pressing the PWR-key.

16:13
Comp init
Please Wait

The compensator in the instrument is now calibrating, please wait.

P0 16:13
Temp=

When the calibration is ready you will step to program 0, where you enter the PPM values, temp, pressure, (humidity), offset and HAref.

ENT **Geodesical**

STD P0 16:13 Am 
HA: 192.8230
YA: 91.7880

The display now switches to Standard Measurement mode. You are now in control over the measurement from the RPU. In the upper right display corner you can see the battery status of the battery connected to the station unit and the function of the A/M-key (see chapter 2.5).

See next page

Robotic
Surveying

Aim & Measure

From previous page

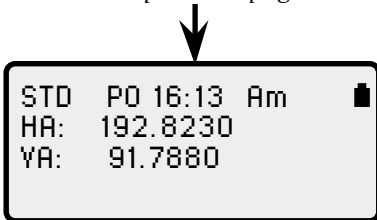

Aim the RMT towards the instrument and press the A/M-key.

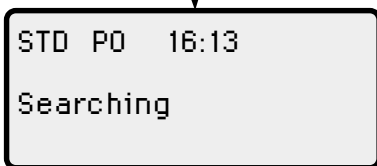

RPU is sending a signal to the instrument and the station starts to search in the sector.

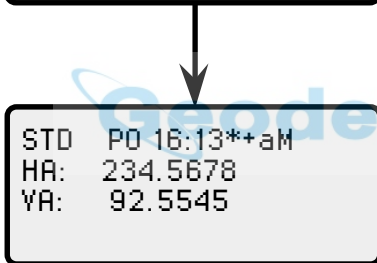

*The station has found the RMT and the system is ready to measure. This is indicated with *, + symbol (please refer to chapter 2.5 for explanation of the symbols).*

Press A/M to measure.

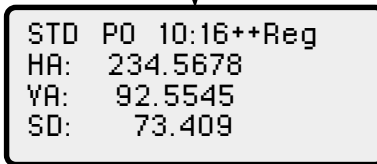

The display will show Horizontal angle (HA), Vertical Angle (VA) and Slope Distance (SD).

Note ! *The A/M-key*

Note - A/M-key

The A/M-key has two functions (Aim and Measure). In the right corner of the display the current function of the A/M-key is displayed, Am-Aim, aM-Measure. A long press on the A/M-key will give you a chance to step backward in the sequence Aim and Measure.

Establishing contact from a detached control unit _____

Note ! ← The previously described method is safer when it comes to radio channel selection. The instrument and control unit must be set to the same radio channel to be able to communicate with each other!

In addition to the methods described on the previous pages in this chapter, it is also possible to establish contact between the station unit and a detached control unit without having a control unit attached at the station unit.

Do as follows:

A/M



Press the A/M key on the backside of the station unit. 1 beep will be heard. Wait until 2 beeps are heard; this means that the telemetric link is on.

PWR



Press the PWR-key at the RPU.



Level the instrument and press the A/M-key.

A/M

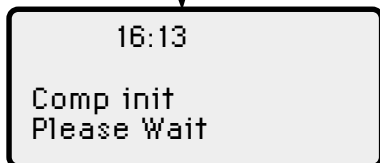

The compensator in the instrument is now calibrating, please wait.

ENT

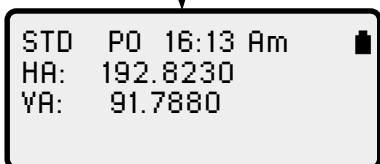

After having gone through program 0 you are now in the Standard Measuring mode. If you are about to perform robotic surveying, it is recommended that you set a search sector in the RPU menu, see chapter 2.5.

See chapter 2.5

Switch to measurement towards an ordinary prism

If you, during a robotic measurement wish to measure towards an ordinary prism (e.g. when you wish to measure outside the range of the tracker), you can configure this in the RPU menu as follows:

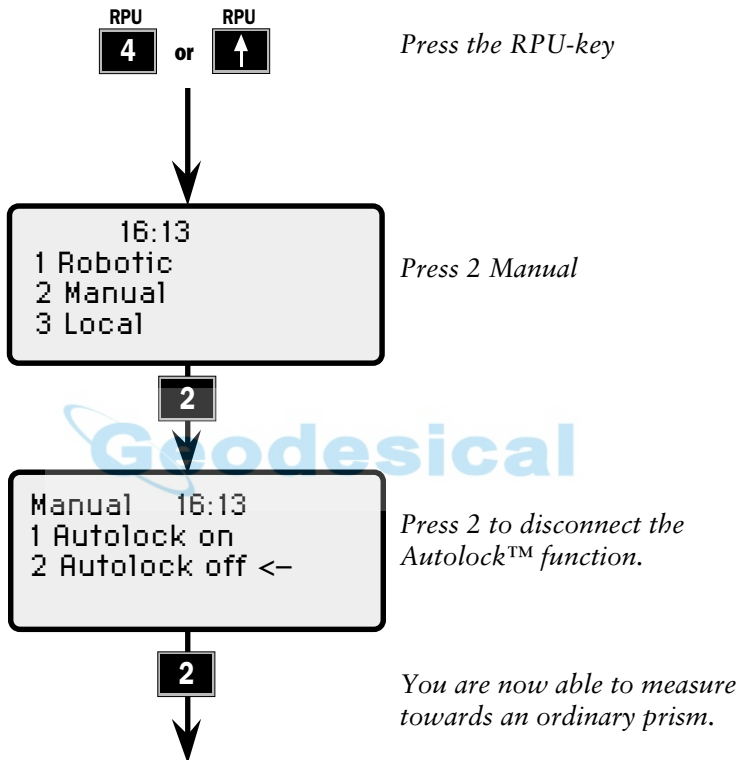

Switch back to robotic surveying

If you wish to switch back to robotic surveying from measuring towards an ordinary prism, do as follows:

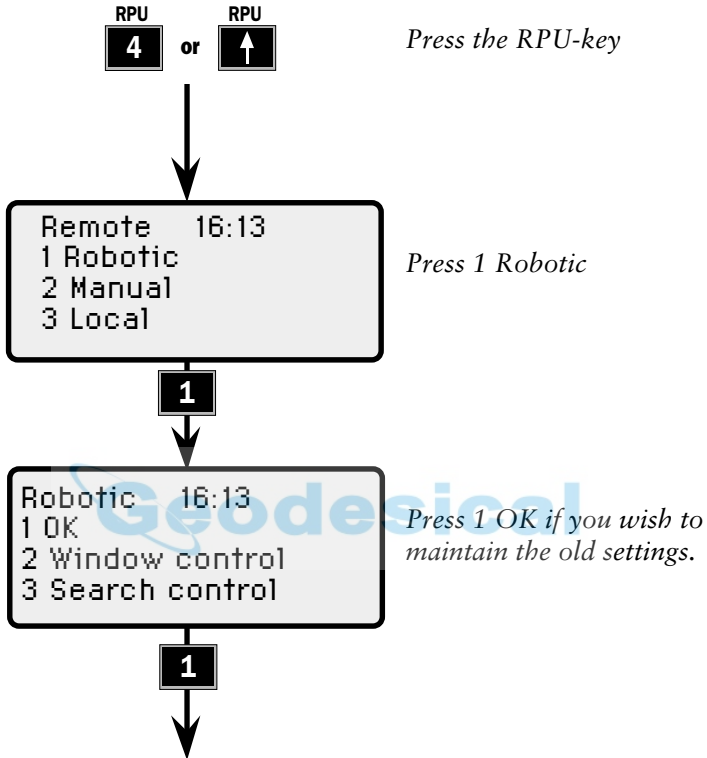

Search functions in robotic surveying

When you are surveying with Geodimeter 600 Pro in robotic mode there is a number of search functions that can be very useful depending on actual application. These functions are described below.

```
STD P0 16:12
HA: 72.0000
VA: 90.0000
```

First press the "RPU"-button on the instrument.

RPU
4 or RPU
 ↑

```
RPU 16:12
1 Autolock
2 Manual ←
3 Remote
```

Choose 1. Autolock for robotic surveying.

1

```
Remote 16:12
1 OK
2 Window control
3 Search control
```

Press 3 Search control.

3

```
Remote 16:12
1 Automatic: on
2 Adv.lock: off
3 RMT600TS: off
```

Here you can choose which function(s) you want to use. Switch between on and off by pressing the corresponding numeric key. Confirm by pressing ENT

ENT

See next page

from previous page



```
STD PO 16:12 Am
HA: 72.0000
VA: 90.0000
```

Now you're taken back to P0 and the selected search function is activated. Below is described the different functions you can choose between.

Automatic: on (in Autolock or Robotic mode)

Automatic search mode means that as soon as the instrument loses lock of the target (RMT) it will begin searching for the target 5 times in the same vertical plane (if you want to search the whole window you need to press the A/M key). As soon as the instrument finds the target it will lock on to it automatically. This function is very useful for ordinary surveying work.

Adv.lock: on (only in Robotic mode)

Advanced lock mode means that if the instrument loses lock of the target (RMT) it automatically locks on to the target as soon as it is visible again. This function is useful if you, for example, are measuring in heavy traffic with cars temporarily blocking the measuring beam. This way you save time since the instrument usually (see "Search mode conflict" below) doesn't start searching each time the measuring beam is being blocked.

Note ! ➡

WARNING! When this switch is activated there is a risk that the instrument could lock on to a window etc. if the tracker signal should come as a reflex from the RMT. After a normal search the instrument always locks on to the strongest tracker signal which, in every case, comes directly from the RMT itself.

RMT600TS: on (only in Robotic mode and with RMT600TS)

Sometimes it can be useful to let the instrument lock on to the RMT600TS without the RMT's vertical sensor being active. This is useful if you must extend the range pole so it isn't possible for you to aim RMT600TS vertically towards the instrument.

Note ! ➡

Search mode conflict

If both Automatic and Adv.lock are set to 'on' there is a conflict. In most cases the instrument will start searching for the RMT after a beam break.

Eccentric Point

Sometimes it is difficult to locate the prism at the point to be measured. This can be solved by considering the point as an eccentric point. Locate the prism at a known distance from the eccentric point, see fig. 5.2 on next page. Works in STD, FSTD (not TRK or D-bar). Available in P0-P19.

```

STD  P0 16:13 Am
HA:  21.4108
YA:  93.0732
SD:  105.213
    
```

Choose menu 12, Preset.

MNU 1 2

```

Preset 16:13
1 Eccentric pt.
2 R.O.E.
    
```

Choose 1 Eccentric pt.

1

```

Eccentric 16:13
Radofs=0.47
    
```

Enter the radial offset and press ENT.

ENT

```

Eccentric 16:13
RT ofs=0.795
    
```

Enter the right angle offset and press ENT.

ENT

See next page

*Note ! ☞
Radofs can also be entered by pressing the function key and 70.*

*Note ! ☞
RT ofs can also be entered by pressing the function key and 71.*

From previous page

```

Eccentric 16:13
Radofs=0.47
RT.ofs=0.795
OK ?
    
```

Are the offset values OK. If so press YES, otherwise press NO.

YES

P0

```

STD  P0 16:13 Am
HA:  21.8643
YA:  93.0968
SD:  105.619
    
```

The values are now updated with the offsets you've entered. The new point will get the same height as the measured point. The next point will be measured without the offsets if you do not enter menu 121 again.

Stored as

```

0=Eccentric pt 2
70=0.47
71=0.795
Updated measured
values according to
the U.D.S being used.
    
```

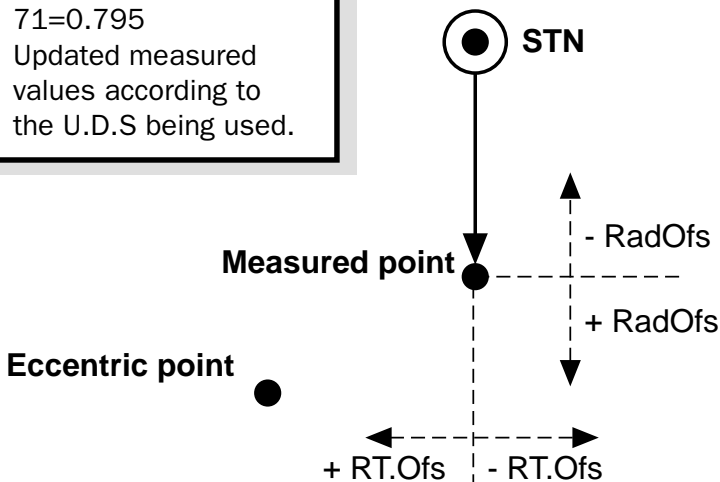

Fig. 5.2 Eccentric point.

The RPU Menu

RPU		Instrument			
4	or	↑			
1 Autolock*	1 OK				
	2 Window control**	1 Auto center 5 Reset	2 Center 6 Remove	3 Editor 7 Left	4 Set 8 Right
	3 Search control	1 Automatic	2 Adv. lock***	3 RMT600TS****	
2 Manual					
3 Remote	1 OK				
	2 Known station 3 Free station 4 Known station+				



RPU		RPU			
4	or	↑			
1 Robotic*	1 OK				
	2 Window control**	1 Auto center 5 Reset	2 Center 6 Remove	3 Editor 7 Left	4 Set 8 Right
	3 Search control	1 Automatic	2 Adv. lock***	3 RMT600TS****	
2 Manual	1 Autolock on* 2 Autolock off*				
	3 Local				

* Only available for servo instruments.

** For further description of Window control, see page 2.2.5

*** Only in Robotic surveying.

**** Only in Robotic surveying using RMT600TS

 **Geodesical**

Important Pages

ASCII Table _____	1.6.2
General measurement hints _____	1.6.4
Info Codes _____	1.6.9



ASCII Table



The ASCII table can be used to enter alpha characters directly from the keyboard on instruments with a numerical keyboard. This can be done with the help of the (ASCII) key.

Value	ASCII Char.						
32	Space	56	8	80	P	104	h
33	!	57	9	81	Q	105	i
34	"	58	:	82	R	106	j
35	#	59	;	83	S	107	k
36	\$	60	<	84	T	108	l
37	%	61	=	85	U	109	m
38	&	62	>	86	V	110	n
39	`	63	?	87	W	111	o
40	(64	@	88	X	112	p
41)	65	A	89	Y	113	q
42	*	66	B	90	Z	114	r
43	+	67	C	91	[115	s
44	-	68	D	92	\	116	t
45	_	69	E	93]	117	u
46	.	70	F	94	^	118	v
47	/	71	G	95	_	119	w
48	0	72	H	96	-	120	x
49	1	73	I	97	a	121	y
50	2	74	J	98	b	122	z
51	3	75	K	99	c	123	{
52	4	76	L	100	d	124	
53	5	77	M	101	e	125	}
54	6	78	N	102	f	126	~
55	7	79	O	103	g		

MNU

66

The instrument also gives you the opportunity to select special characters for different languages. This can be done via Menu 66. The following languages and characters can be selected.

Value	Sw	No	De	Ge	Uk	It	Fr	Sp
35							à	
64		É	É	f	#		°	
91	Ä	Æ	Æ	Ä		°	Ç	í
92	Ö	Ø	Ø	Ö			f	Ñ
93	Å	Å	Å	Ü		é		¿
94	Ü	Ü	Ü					
96	é	é	é			ù	é	
123	ä	æ	æ	ä		a	ù	ë
124	ö			ö		õ	ù	ñ
125	å	å	å	ü		e	ë	
126	ü	ü	ü					ì

General measurement hints

Backup of memory

As a safety measure always backup your memory to protect yourself from memory loss. Ensure that your data can be found in more files than one and if possible in more than one place.

Backup is easily done with Program 54 which enables you to transfer Job- and Area-files between the different Geodimeter units or to a PC, see "Software and Data communication" for more information. You can also use the PC-program Geotool, ask your local dealer for a demonstration.

Reboot the keyboard unit

Measurements will be stored in the memory of the keyboard unit attached to the instrument. The data system is designed to max. security with write protection of the data memory and a backup of the working area of the programs. If a lock up or an error of the program should occur which cannot be resolved by just a restart of the instrument, there is a new reboot action available:

1. Disconnect the keyboard unit from the instrument and connect it to an external battery.
2. Start the keyboard unit by keeping the **CON** key and **PWR** depressed at the same time.
3. In the display will 2 options be available.
4. Choose 2. Reboot and a reboot will occur.

Note that in this case all functions will be reset and all self-made U.D.S. will be lost.

Fast check of the collimation errors (only servo)

1. Aim at the point exactly.
2. Press the ↶ button.
3. Look at reticle. The difference in aiming represents the value of the current collimation errors (dH and dV).
4. If you consider them too large we recommend you to perform a test measurement (MNU 5).

General measurement hints (cont)

Extend the straight line (only servo and at the instrument)

When you wish to measure as shown in the illustration below, i.e. first measure towards a point and then rotate the instrument to a point that lies on a straight line from the first point, you should turn the instrument 180° (200 gon) and not rotate the instrument to face 2. This is because in the second case the instrument will not correct any collimation errors. With a long press on the \blacktriangleleft key you will rotate the instrument 180° (200 gon)

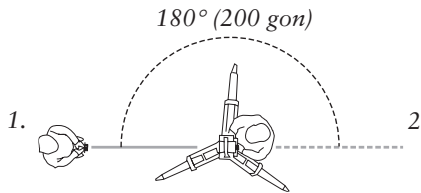

Collimation errors

The instrument will automatically correct the measured angles for both horizontal and vertical collimation errors as well as for trunnion axis errors by using premeasured values. By carrying out a test procedure, see chapter 2, you can update these values for the actual conditions. We recommend you to do this regularly especially when measuring during high temperature variations and where high accuracy is demanded in one face.

Test measurements should be carried out with the keyboard configuration current for the measurement.

Tilt axis

When measuring towards a point, the instrument will correct the measured angles as described above. If you tilt the telescope up/downwards you will find that the horizontal angle will change, this is an illustration of tilt axis and two-axis level compensator correction, which both are dependent of the vertical angle.

However if you point the telescope to a vertical level string you will find that the horizontal angle will remain constant.

General measurement hints (cont)

How to combine labels 26, 27, 28 and 29

1. Positioning of HA and VA

If you wish to aim at a point when you know HA and VA you should use label 26 and 27.

2. Set out points with bearing and distance

If you know the bearing and the distance to a point you should use label 27 and 28. With label 29 you can also set out the height.

Note - Do not use label 26 for positioning the height of the point. Use instead label 29 and let the instrument calculate the VA.

3. Set out points with known coordinates

If the station is established (via program 20 or menu 3) you can use label 67 and 68. With label 69 you can also set out the height.

Note - If you use label 67, 68 or 69, this will also have effect on label 27 and 28.

4. Set out points in height with the servo control key

To position the height use the ∇ button. If the distance has not yet been measured, the instrument will be positioned in height based on the theoretical distance.

If the distance has been measured the instrument will be positioned in height to the measured point, i.e. the height will always be correct even if you do not aim exactly at the correct point.

Fetch Station data (MNU 33)

If you have established a station with program 20 and the station coordinates is somehow destroyed (e.g. with an overriding U.D.S. containing station, IH, Refobj.), you can retrieve the original station coordinates with menu 3.3. Note ! This does not work if label 21 has been changed.

General measurement hints (cont)

How to set out using Autolock™ (only servo)

1. Switch on Tracklight.
2. Select the point to set out.
3. Aim the instrument towards the point by pressing .
4. The prism holder looks for the white light from Tracklight without aiming the RMT towards the instrument.
5. When the prism holder is inside the white light, he/she turns the RMT towards the instrument.
6. At the prism, choose the display page that shows Radofs and RT ofs and guide the prism holder to the right set out point.

Measuring towards corners using Autolock™ (only servo)

1. Choose FSTD, STD or D-bar.
2. Aim towards the RMT, press A/M and you'll get frozen display values.
3. Turn the RMT away from the instrument.
4. Press the CON-key.
5. Aim the instrument towards the corner.
6. Press the REG-key to registrate the measurement.

How to check what's installed in your keyboard unit.

1. Make a long press on your PRG key.
2. Now you're in the UDS library. Press the corresponding key below DIR.
3. Now you're in the PRG library. Press the corresponding key below DIR.
4. Now you can see the options installed in your keyboard unit. Step between the installed options with the corresponding keys below the arrows <- and ->.

Temporary Horizontal Angle in P0

The temporary horizontal angle feature in Program 0 can be useful if you want to turn the instrument without affecting the original HA. This function is called HA_L, Horizontal Angle from a Line, and results in an extra line

General measurement hints (cont)

in the display showing HA_L=0.0000. You activate the HA_L function by pressing key 5. Reset HA_L by pressing key 5 again. Exit HA_L with a long press on key 5. Note that this function only works in Program 0.

Description of Label 23

Label 23 can be used in an U.D.S. to log which units that were current during the measurement.

Note!

You cannot change the value of this label with F23, you must instead use MNU 6.5.

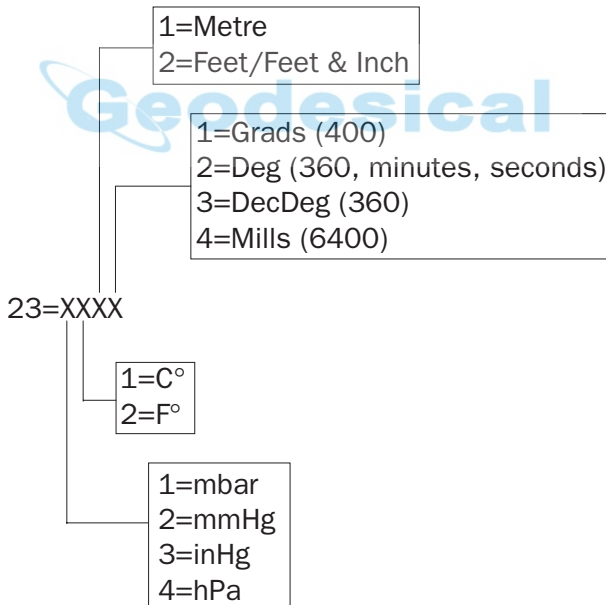

ex. if 23=2111, means that the units are mmHg, C°, Metre and Grads.

The following pages will describe the different info codes that can appear in Your Geodimeter. If an error appears frequently the instrument should be left to authorized service.

In some cases the info code also includes a device code, e.g 22.2. The most frequent codes are:

1=Serial, 2=Imem, 6=Radio, 7=Distance meter

If a device code appears, check the info code description. If the code is not described the error is internal and the instrument should be left to authorized service.

Info 1 – Compensator out of range

Cause: The instrument is tilted too much. The dual-axis compensator can not compensate for the inclination.

Action: Level the instrument or disconnect the dual-axis compensator.

Info 2 – Wrong face

Cause: The operation was carried out while the instrument was in an illegal mode. E.g: Trying to measure in the wrong face.

Action: Change to face 1, showing angles in the display and retry.

Info 3 – Distance already recorded

Cause: The distance to the current object has already been registered.

Action: If a new registration is required a new measurement must be carried out.

Info 4 – Invalid measurement

Cause:

- The measurement is invalid, e.g. several measurements towards the same point or the measured points lies 200 gon from each other, P20, Free Station.
- Trying to perform a calculation which is dependent from a distance without having measured any distance, P20 Free Station and Z/IZ.

Action:

- Check that the circumstances above does not occur and redo the measurement.

Info 5 – Undefined mode or table

Cause: Tries to use a display- or output-table that does not exist.

Action: Choose another table or create a new.

Info 6 – Vertical angle less than 15gon from horizontal angle

Cause: The vertical angle is less than 15gon from the horizontal angle when performing a Tilt Axis Calibration.

Action: Redo the calibration with an increased horizontal angle.

Info 7 – Distance not yet measured

Cause: Tries to register without having performed a distance measurement. E.g: when using an U.D.S. which includes labels that are dependent from a distance.

Action: Perform a distance measurement before registration.

Info 10 – No active device

Cause: Tries to register in an U.D.S. without having defined a storage unit.

Action: Check that the U.D.S. includes a logon procedure. Restart the U.D.S. and choose a storage unit (IMEM or Serial).

Info 19 – Communication error

Cause:

- The cables are not connected correctly or are damaged.
- The battery is drained.
- The data for transfer contains errors.

Action:

- Check that the cables are connected properly.
- Check that the batteries are not drained.
- Run the transfer again and check if any error appears. If so check the file for any errors and correct them.

Info 20 – Label error

Cause: You have entered a wrong labelnumber. The label does not exist, is not correct or does not contain any data.

Info 21

- Cause:**
- Wrong communication parameters (label 78).
 - The cables are not connected correctly or are damaged.
 - The battery is drained.
- Action:**
- Check that the same parameters are set in the target unit as in the source unit.
 - Check that the cables are connected properly.
 - Check that batteries are not drained.
-

Info 22 – No or wrong device connected

- Cause:** Tries to access a device that is not connected or working.
-

Info 23 – Time out

- Cause:** An error occurred during a communication session.
- Action:**
- Check that the batteries are not drained.
 - Check that the cables are connected properly.
-

Info 24 – Illegal communication mode

- Cause:** The operation was carried out while the instrument was in an illegal mode.
- Action:** Set the instrument in face 1 (P0), press STD, TRK or D_bar and retry.
-

Info 25 – Real time clock error

- Action:** Try to set date and time. If that does not help the instrument should be left to authorized service.
-

Info 26 – Change backup battery

- Action:** The instrument can be used but should be left to authorized service for replacement of the battery. There is a risk for total loss of memory.
-

Info 27 – Option not installed

Cause: Tries to select a program which is not installed in the instrument.

Action: Choose another program or contact Your local Geodimeter dealer for a program installation.

Info 29 – The current table can not be changed

Cause: Tries to modify the current display- or output-table.

Action: To be able to modify the current table, you must first select another table to be the current.

Info 30 – Syntax error

Cause: Tries to send a command with illegal syntax on the serial channel.

Action: Check the command and change the syntax. Note that only big letter commands are allowed.

Info 31 – Out of range

- Cause:**
- Tries to choose an illegal display- or output-table.
 - Tries to choose a display- or output-table that does not exist.
 - Tries to create an illegal U.D.S.
 - Tries to measure too long a distance.
-

Info 32 – Not found

- Cause:**
- Tries to access a Job- or Area-file that does not exist.
 - Tries to access an illegal program.
-

Info 33 – File record exist

Cause: Illegal way of creating a Job- or Area-file

Info 34 – Illegal record separator

Cause: Tries to insert a label in the editor when you have a Job No or Area No in the display.

Info 35 – Data error

Cause: Wrong data input, e.g. value out of range or alpha sign in a numeric value.

Info 36 – Memory full

Cause:

- Too many point codes in the point code library (Program 45) or too many characters in the point codes.
- Too long display- or output-table.
- Internal memory full.

Action:

- Use less characters in the point codes.
- Shorten the tables or use fewer tables.
- Install more memory at your local dealer or delete unused files.

Info 41 – Wrong label type

Cause: This label type can not be attached to this specific label.

Action: Choose another label or use another label type.

Info 42 – U.D.S. program memory full

Action: Delete unused U.D.S. programs or shorten the programs.

Info 43 – Calculation error

Action: Redo the procedure.

Info 44 – Not enough data for calculation

Cause: The program needs more points for the calculation, P20, Free Station.

Action: Measure more points and redo the calculation.

Info 46 – GDM power error

Cause: RPU can not switch on GDM.

Action: Redo the procedure. If the error appears again leave the instrument to authorized service.

Info 47 – U.D.S call stack error

Cause: You have used call in too many steps (max 4 steps).

Action: Check the U.D.S's and decrease the number of calls.

Info 48 – No or wrong station establishment

Cause:

- The station labels has been changed since the station was established.
- The station is not established.

Action: Perform a station establishment.
If using a RPU and if the station has been established earlier, fetch station data with menu 33.

Info 49 – RPU not logged on to GDM

Cause: Tries to perform an operation that demands a RPU.

Action: Logon the RPU to the GDM and redo the operation.

Info 51 – Memory lost

Action: Reboot the instrument (see page 1.6.4). If that does not help, leave the instrument to authorized service.

Info 54 – Memory lost

Action: Reboot the instrument (see page 1.6.4). If that does not help, leave the instrument to authorized service.

Info 103 – No carrier

Cause: Disturbance or no contact over the telemetry link.

Action: Change channel or decrease the distance between the RPU and the GDM.

Info 107 – Channel busy over the telemetry link

Action: Change channel.

Info 122.6 – Radio not connected (Can also show info 22.6)

- Cause:**
- The radio is not connected to the Geodimeter.
 - The radio is not switched on.
 - The battery in the radio is drained.
 - The cables are not connected properly or are damaged.

Action: Connect the radio to the Geodimeter and switch on the radio.

Info 123 – Time out (Can also show info 23.6)

- Cause:**
- The battery in the radio is drained.
 - The cables are not connected properly or are damaged.

Action: Check the cable connections and examine the radio battery.

Info 153 – Limit switch engaged

Cause: Tries to position the instrument to an illegal angle.

Info 155 – The horizontal positioning is not good enough

Action: If this error appears frequently leave the instrument to authorized service.

Info 156 – The vertical positioning is not good enough

Cause: If this error appears frequently leave the instrument to authorized service.

Info 157 – The horizontal & vertical positioning isn't good enough

Action: If this error appears frequently leave the instrument to authorized service.

Info 158 – Can not find the target

- Cause:**
- The aiming from the RPU is bad.
 - The measuring distance is too long.
 - The measuring beam was obstructed.

Action: Try to aim the RPU towards the Station more accurate and remove any obstructing object. If possible try to reduce the measuring distance.

Info 161 – The target is lost

- Cause:**
- The aiming from the RPU is bad.
 - The measuring beam is obstructed.
 - The target was moved too fast.

Action: Try to aim the RPU towards the Station more accurate and remove any obstructing object. If not in tracking mode, it is important to hold the target still while measuring.

Info 162 – Syntax error (see Info 30)

Info 166 – No measuring signal from prism

Cause: The distance meter in the instrument or the prism is obstructed.

Action: Remove any obstructing object from the instrument and the prism.

Info 167 – Collimation error too large

Cause: The collimation error during a test measurement was too large.

Action: Increase the measuring distance. It is important to keep the RPU held still during the measurement. If the error does not disappear leave the instrument to authorized service.

Info 174.7 – Distance measurement error

Action: Redo measurement.

Info 175.7 – Distance Measurement error

Cause: Especially in TRK mode when you start to measure a distance to one prism and end the measurement to another one.

- Action:**
- Wait until the error message disappears. The next distance measurement will be correct.
 - Measure in FSTD (Fast Standard Mode).
-

Info 201 – Calculation error (see Info 43)

Info 207 – Process queue overflow

Cause: Too many commands sent too fast on the serial channel.

Action:

- Wait for the result of one command before you send the next one.
- Switch off and restart if keyboard is attached on the instrument.

Info 217 – RS-232 Buffer Overflow

Cause: Data was sent without an end sign.

Action: Make sure that the command contains an end sign.

Info 218 – Input string too long

Cause: A command that is too long was sent on the serial channel.

Action: Send a shorter command.



 **Geodesical**

Part 2

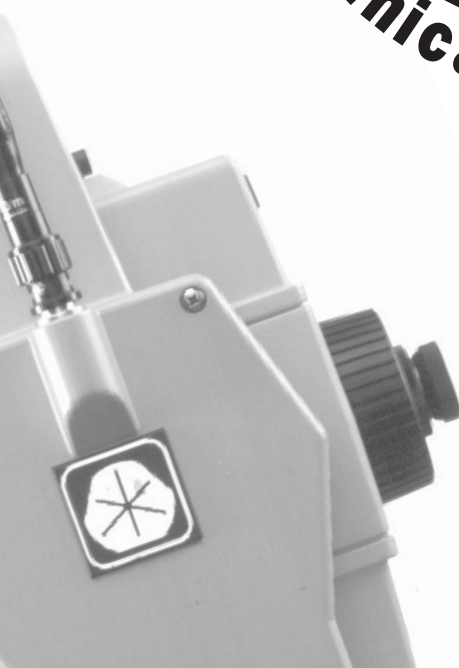

 **Geodesical**

Angle Measurement System

Overview _____	2.1.3
The Angle Measurement Technique _____	2.1.3
Dual-Axis Compensator _____	2.1.3
Correction for Collimation Errors _____	2.1.4
Correction for Trunnion Axis Tilt _____	2.1.4
Calculation of the Horizontal Angle _____	2.1.5
Calculation of the Vertical Angle _____	2.1.5
Single - Face Angle Measurement _____	2.1.6
Two - Face Angle Measurement _____	2.1.6



Illustrations _____

Fig 1.1 The Angle Measurement System

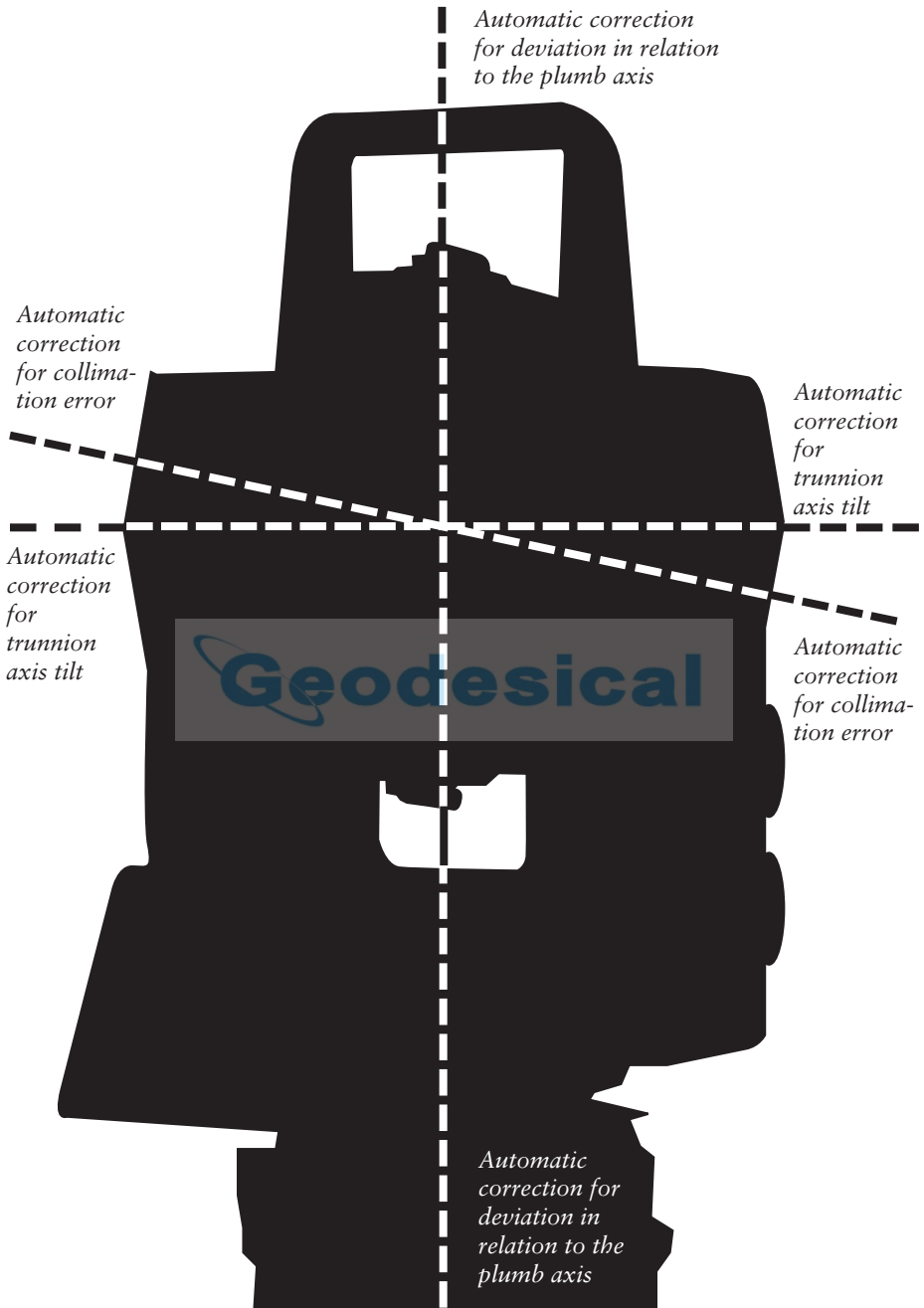

Fig 1.1 The Angle Measurement System

Overview

The Geodimeter System 600 meets all demands for efficient and accurate angle measurement. It also allows you to choose the measuring method with which you feel most comfortable. The angle measurement system gives you full compensation for the following:

- Automatic correction for angle sensor errors.*
- Automatic correction for collimation error and trunnion Axis tilt.*
- Automatic correction for tracker collimation error.*
- Arithmetic averaging for elimination of pointing errors.*

The Angle Measuring Technique

One of the strong features of the design of Geodimeter System 600 is its electronic angle measurement system, which eliminates the angle errors that normally occur in conventional theodolites. The principle of measurement is based on reading an integrated signal over the whole surface of the angle sensor and producing a mean angular value. In this way, inaccuracies due to eccentricity and graduation are eliminated.

Dual Axis Compensator

The instrument is also equipped with a dual axis compensator which will automatically correct both horizontal and vertical angles for any deviations in the plumb line. The system warns immediately of any alterations in excess of $\pm 10^\circ$ (6').

Correction for Collimation Errors

By carrying out a simple pre-measurement test procedure, both horizontal and vertical collimation of the instrument can be quickly measured and stored. All angles measured thereafter are automatically corrected. These collimation correction factors remain in the internal memory until they are measured again.

Correction for Trunnion Axis Tilt

During the same pre-measurement test procedure, it is also possible to measure and store angular imperfections of the horizontal tilt axis relative to the horizontal axis. This stored correction factor is applied automatically to all measured horizontal angles.

When should these tests be carried out?

1. After transport where hard handling may have occurred.
2. When the temperature differs by $> 10^{\circ}\text{C}$ from the previous application.
3. If you have changed the keyboard unit configuration since the latest calibration. (You can use one, two or none keyboard unit).
4. Immediately prior to high precision angle measurement.

How are these tests carried out?

See "Test Measurements", part 1, page 1.2.19.

Calculation of the Horizontal Angle

The formula below is used to calculate the horizontal angle:

$$HA = HAs + Eh * 1 / \sin v + Yh * 1 / \tan v + U * 1 / \tan v$$

(*sin v = collimation tan v = levelling tan v = horizontal axis*)

HAs = Horizontal angle measured by the electronic sensor.

Eh = Horizontal collimation error.

Yh = Levelling error at right angle to the telescope, corrected by the automatic level compensator.

U = Horizontal axis error.

Calculation of the Vertical Angle

The formula below is used to calculate the vertical angle:

$$V = Vs + Ev + Yv$$

Vs = Vertical angle measured by the electronic sensor.

Ev = Vertical collimation error.

Yv = Deviation in the vertical axis, measured by the automatic level compensator.

Single-Face Angle Measurement

The above described features admits efficient and accurate angle measurement in a single face, since the instruments errors are automatically corrected with constants which are stored during the test measurement.

During Single Face angular measurements, with the compensator engaged and pre-measurement and storage of collimation and tilt axis errors have been executed, each displayed angle will be compensated for the following:

- Horizontal and vertical circle graduation and eccentricity errors.*
- Plumb line deviation errors.*
- Horizontal and vertical collimation errors.*
- Tilt axis errors.*

It is worth mentioning that human error sources such as telescope sighting (these errors can be almost nullified by measuring in two faces) and imperfections in the optical plummet of the tribrach still remain.

Two-Face Angle Measurement

The instrument can be used in exactly the same manner as a conventional theodolite, i.e. in both the left and right face. These two-face situations will hereafter be referred to as Circle 1 and Circle 2 positions.

Two face measurements can be used for legal reasons, or when additional concern of accuracy and documentations is demanded.

When measuring in STD-mode you measure and store each angle value of the two faces and get a display value of the total collimation and sighting error.

When measuring in D-bar mode you can decrease the sighting error by repeating measurements and mean value calculation of each sighting. The number of repeated sightings can be chosen depending on the current measuring conditions. The final mean value calculated angles are displayed and stored in this mode. Angle values for each face are also available.



Distance Measurement System

Overview _____ 2.2.3

Distance Measurement _____ 2.2.3

Standard Measurement (STD Mode) _____ 2.2.4

Fast Standard Measurement (FSTD Mode) _____ 2.2.4

Precision Measurement (D-bar Mode) _____ 2.2.5

Tracking Measurements (Setting Out) _____ 2.2.6

Measurement Toward Moving Targets (Tracking Mode) _____ 2.2.7

Long Range Measurements _____ 2.2.7

Eccentric Objects _____ 2.2.8

Signal Level _____ 2.2.9

Beam Width _____ 2.2.9

Range _____ 2.2.9

Accuracy _____ 2.2.9

Important information when measuring with high accuracy _____ 2.2.9

Remote Object Elevation (R.O.E) _____ 2.2.10

R.O.E Examples _____ 2.2.11

UTM Scale Factor Corrected Distances _____ 2.2.13

UTM Example _____ 2.2.14

Illustrations _____

Fig 2.1 Measuring against eccentric point.

Fig 2.2-2.4 Different combinations of IH and SH when using
R.O.E.

Fig 2.5 UTM Scale Factor.



Overview

The distance module of Geodimeter System 600 operates within the infrared area of the electromagnetic spectrum. It transmits an infrared light beam. The reflected light beam is received by the instrument and, with the help of a comparator, the phase delay between transmitted and received signal is measured. The time measurement of the phase delay is converted and displayed as a distance with mm accuracy on the four-line LCD.

Note! 

When taking measurements with servo instruments and having the Tracker installed there may be a distance error if you use large prisms. See page 2.2.9 for further information!

Distance Measurement

The internal function of the distance measurement module can be varied depending on the nature of the particular survey application in question. There are four methods of distance measurement.

STD

- Standard measurements towards stationary targets (standard mode)*

STD

- Fast measurements towards stationary targets (fast standard mode)*

\bar{D}

- Precision measurements towards stationary targets (arithmetical mean value \bar{D} mode)*

TRK

- Measurements towards moving targets (tracking mode) e.g., setting out or hydrographic surveying. Also functions as automatic measuring mode for polar measurement and tacheometry.*

The choice of measurement method is often based on the experience of the operator and of course the practical precision demanded by the current survey task.

STD**Standard measurement (STD Mode)**

This measurement mode is normally used during control surveys – e.g., traversing, minor tacheometric exercises, survey point accuracy control, etc. Measurement time to each point takes 3.5 seconds. This measurement mode is also normally used where a normal degree of angle and distance accuracy is required.

The instrument carries out the measurement and display of horizontal and vertical angles and slope distances. Horizontal distance and difference in height, and the northings, eastings and elevation of the point will all be displayed by pressing the ENT key twice. Collimation and horizontal axis tilt errors are compensated and full angle accuracy can be achieved with one-face measurements. The instrument also offers the possibility of using the R.O.E. function in the STD-measurement mode (see page 2.2.10). Limited horizontal movement of the instrument telescope, i.e. within 30 cm, will also result in the northings and eastings of the measured point changing. This feature is used when measuring of eccentric objects (see page 2.2.7.).

STD**Fast standard measurement (STD mode)**

This measurement mode is used when the object is stationary but the demands on precision are low. The measurement time is very short, approx. 1.3 seconds.

The measurement is performed in the same way as the standard measurement.

MNU**6****2****Switch between Fast Standard and Standard Measurement Mode**

You can configure the STD-key to work in Standard- or Fast Standard mode in menu 62.

D**Precision measurement (D-bar)**

This measurement mode is normally used during control surveys – e.g., traversing, minor tacheometric exercises, survey point accuracy control, etc. Measurement time to each point takes 3.5 seconds. This measurement mode is similar to the one-face STD mode, the major difference being that distance measurement is carried out in a repeated measurement cycle thus resulting in higher accuracy.

The instrument carries out the measurement and display of horizontal and vertical angles and slope distances. Horizontal distance and difference in height, and the northings, eastings and elevation of the point will all be displayed by pressing the ENT-key twice. Collimation and horizontal axis tilt errors are compensated and full angle accuracy can be achieved with D-bar one-face measurements. The instrument also offers the possibility of using the R.O.E. function in the D-bar measurement mode (see page 2.2.10).

Note that when using the R.O.E.-feature the distance measurement has to be interrupted by pressing the A/M-key. Limited horizontal movement of the instrument telescope up to 30 cm will result in the northings and eastings of the measured point changing, also after pressing the A/M-key.

TRK

Tracking measurement (Setting Out)

The tracking measurement mode is used for setting out with the option of using countdown to zero of both the horizontal bearing (azimuth) and distance to the setting out point. The instrument very quickly calculates the difference between the present direction and the required direction to the point to be set out and the difference between the horizontal distance measured and the required horizontal distance to the point. These differences are visible on the display and when both the dHA (difference in horizontal angle) & dHD (difference in horizontal distance) = 0 ("countdown to zero"), the range rod is then being held over the required setting out point. The actual setting out can be carried out in two different ways in the standard version of the instrument:

SHA = F27
SHD = F28
SHT = F29

- Keying in of bearings (SHA), distances (SHD) and height (SHT) to the points, after first calling up F27 (SHA), F28 (SHD) and F29 (SHT) respectively.
- Keying in of instrument station data (including instrument height =IH) and set out point data by using the main menu, Option 3, Coord, choices 1 and 2. The instrument will then calculate the bearing (SHA), the horizontal distances (SHD) and the height (SHT), between the instrument station point and each individual keyed in setting out point. After setting out the point and checking the point coordinates and elevation, you re-enter the main menu and key in the coords and elevation of the next setting out point. For more information see Page 1.4.27.

MNU

3

1

Measurement towards moving targets

The TRK mode is fully automatic. All measured values will be updated 0.4 sec. after making contact with the prism. No keys have to be pressed between measurements. It is worth pointing out that battery power consumption is a little higher in this measurement mode compared to the execution of tacheometry in STD-mode. R.O.E is automatic in this measurement mode.

MNU**1****6**

*Long
Range
on/off*

Long Range Measurements

If you have the Long or Medium Range option installed in your instrument you can enable/disable a special function called "Long Range" by accessing MNU 16. If Long Range is enabled you will see the "Long Range" text in the display every time you press the A/M button in STD or D-bar mode. If you are unsure whether you have the option installed you can check that by making a long press on the PRG-key. In the first row you will find the characters "LR" or "MR" if you have the options installed.

Target Data Test On/Off

This allows measuring to points over which the prism range pole cannot be placed – eg., in a corner or at the centre of a large tree. In such a case the instrument can be redirected to the correct point after distance measurement. The offset distance from the inaccessible point is limited to +/-30cm or 50mgon rotation of the instrument for distances within 400m. This limit allows you to calculate and record the coordinates and elevation of the correct point – i.e. the eccentric point. For distances in excess of 400m the offset limit is proportional to the distance to the point – e.g. at a distance of 1200m, the instrument can be re-directed to the correct point up to an offset distance of 90 cm.

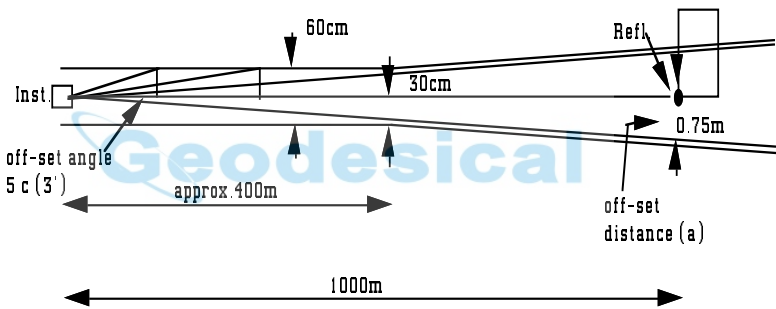

Fig. 2.1 Measuring against eccentric point.

MNU

6

1

Target
Data
Test On/
Off

This +/-30 cm or 50mgon limit can be deactivated by using the main menu CONFIG function, Option 1, Config Switches, Target Data Test OFF mode. The default(standard) setting of this switch will always be ON when the instrument is first turned on.

Warning!

The target Data Test is created for your safety. It prevents you from storing an old distance with new angle values. When Target Data Test is set to Off that risk will occur, if you forget to measure a distance when measuring the following points.

Automatic control of signal level

The Geodimeter instruments have an automatic signal control which adjusts the measurement signal level for the optimal value for each distance measured.

Measurement beam width

The infrared measurement beam has a width of 16 cm/100m (≈ 6 inch/300 feet)(1.6 mrad). The wide measurement beam simplifies considerably both target/prism acquisition and setting out exercises.

Measurement range

The Geodimeter instruments have an range capability of 0.2m to 3500m (depending on the type of instrument) with only one prism in normal weather conditions (Standard clear).

Accuracy

Since the Geodimeter instruments are constantly improved we refer to the Technical Specifications sheets for the up-to-date accuracy figures of the respective models.

Important information when measuring with high accuracy

To achieve the highest accuracy when measuring distances shorter than 200 meters and having the Tracker unit installed on your instrument you need to be aware of the following:

If you use a large reflector like the Super Prism (Part no. 571 125 021) or the Tiltable Reflector (Part No. 571 126 110) you need to cover the tracker aperture before you measure the distance. Otherwise reflections from the Tracker unit may have influence on the measured distance. The error can vary from 0 to 3 mm. If you use a Miniature Prism (Part no. 571 126 060 or 571 126 100) this error doesn't occur.

R.O.E (Remote Object Elevation)

The R.O.E. measurement function is used to measure heights of objects where it is not practical or impossible to place a reflector. In order to measure the height of an object, an initial distance measurement is carried out to a reflector held at a point which is in the same vertical plane as the point to be measured. Once the distance has been measured, the height can be measured to any point which lies within the same vertical plane as the point's location.

The height is calculated from the horizontal distance measured and the vertical angle for the point at which the reticle of the telescope is pointed.

MNU

1

2

R.O.E. can be preset to 0 or any other value by using menu 1.2, R.O.E. preset. Note that you don't have to activate the R.O.E. function – it is always active as long as you are in Program 0.

"R.O.E
preset"

An example: Let's say you want to measure the height of a building, from the ground to the top. Place the rod close to the building. Take a measurement to the prism, select a display that shows VD or ELE. Tilt the telescope to the bottom of the rod and select MNU 12, R.O.E. Preset, and key in 0.000. If you can't see the bottom of the rod you can aim to the prism and key in the height of the prism as R.O.E. Preset, e.g. 3.000. Now, when you tilt the telescope to the top of the building you can see the height in the display shown as VD or ELE.

With Geodimeter Instruments it is possible to make use of the R.O.E. feature in all three measurement modes, i.e. Standard, D-bar and Tracking. As it is possible to key in instrument station coordinates and elevations, and instrument and signal heights, and by the choice of display mode of the instrument, it is also possible to work with and see immediately the northings, eastings and elevations of the points. This will allow you to work directly from the engineer's drawing without needing to pre-calculate bearings, distances and heights.

The R.O.E. is reset in STD and D-bar mode by a new measurement.

Different combinations of Instrument Height (IH) & Signal Height (SH)

It is important to know what the different combinations of instrument and signal heights will produce in the form of displayed results.

- 1) If you do not key in either instrument or signal height, the vertical distance (VD) shown on the display is the difference between the horizontal axis of the instrument and the point at which the telescope reticle centre is pointing.

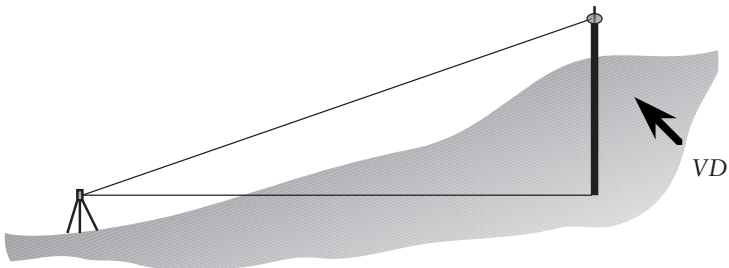

Fig. 2.2

- 2) If you key in the height of the instrument (IH) and the height of the survey point over which the instrument is placed, and set the signal height (SH) of the target to 0, the vertical distance (VD) shown on the display is the difference in height between the station ground point and the point at which the telescope reticle centre is pointing.

The VD value, obtained by changing display page, shows the absolute height.

This is the method which should be used when setting out heights directly from the engineer's drawing, for example.

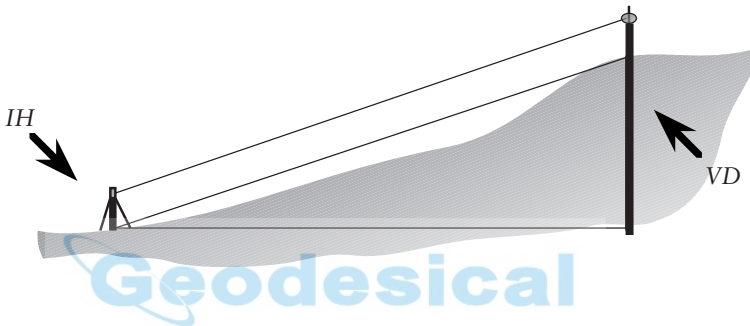

Fig. 2.3

- 3) If you key in both the instrument and signal height, the vertical distance (VD) which is shown on the display is the difference in height between the point over which the instrument is placed and the ground level of the point at which the reflector is placed – i.e., the actual difference in elevation between the two ground points.

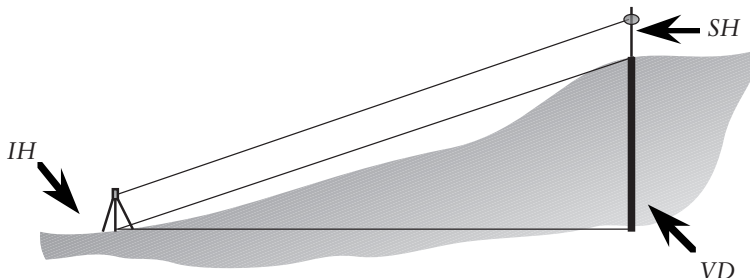

Fig. 2.4

UTM Scale Factor Corrected Distances

In all Geodimeter instruments you can set the UTM Scale Factor (UTM = Universal Transverse Mercator Scale Factor) and can therefore carry out both Tacheometry and Setting Out using UTM Scale Factor corrected distances.

UTM Scale Factor tables can be acquired from local government surveying authorities. The scale factor used by the operator is solely dependent on the location of the survey area in relation to its East-West distance from the UTM zone central meridian. These zones are 6° degrees wide and originate from the 0° Greenwich meridian. North-South distances within the UTM zone have no influence on the scale factor. The scale factor at the CM (Central Meridian) of UTM zones is 0.9996. This is the smallest value. The UTM Scale Factor towards the east and west from the CM will therefore increase upwards towards 1.000400. These values are listed in tables showing corresponding UTM Scale Factors in relation to distance (E-W) from the CM of the zone.

The UTM Scale Factor is set with Function 43. The UTM set in Geodimeter is always the same for both Tacheometry and Setting Out. The display shows the following when selecting F43.

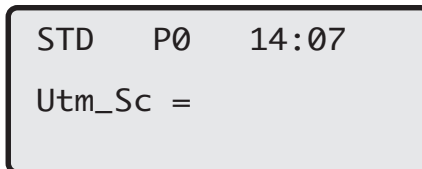

Examples of optional programs with which Function 43 can be used:

P20 : Known Stn./Free Stn.

P23 : SetOut

P26 : DistOb (Distance between 2 objects)

UDS which includes distance measurements.

- F**
- 4**
- 3**

UTM Example

The UTM coord. distance is represented by the line AB (see sketch below). The measured horizontal distance CD on the Geoid must therefore be reduced to AB, with the UTM scale factor for example 0.999723. This is simply done by multiplying CD (the horizontal distance) with your scale factor. This routine will be carried out automatically when keying in a UTM Scale Factor using Function 43.

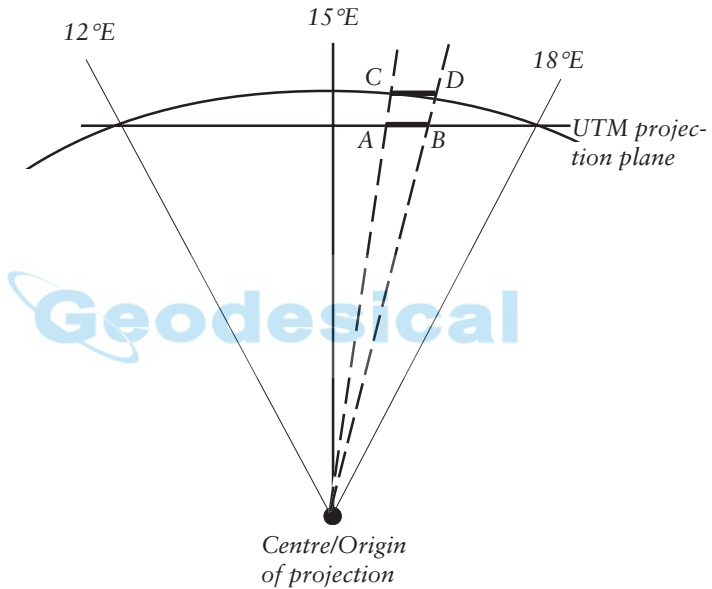

Fig. 2.5 UTM Scale Factor.

* * *

Tracklight®

Overview _____	2.3.3
How to activate _____	2.3.4
Changing the Bulb _____	2.3.5

Illustrations _____

- Fig. 3.1 Tracklight.
- Fig. 3.2 Connecting the Tracklight unit.
- Fig. 3.3 Activation of the Tracklight.
- Fig. 3.4 Changing the bulb.



Fig 3.1 Tracklight emits a red, white and green sector of flashing light where the white light coincides with the measuring beam.

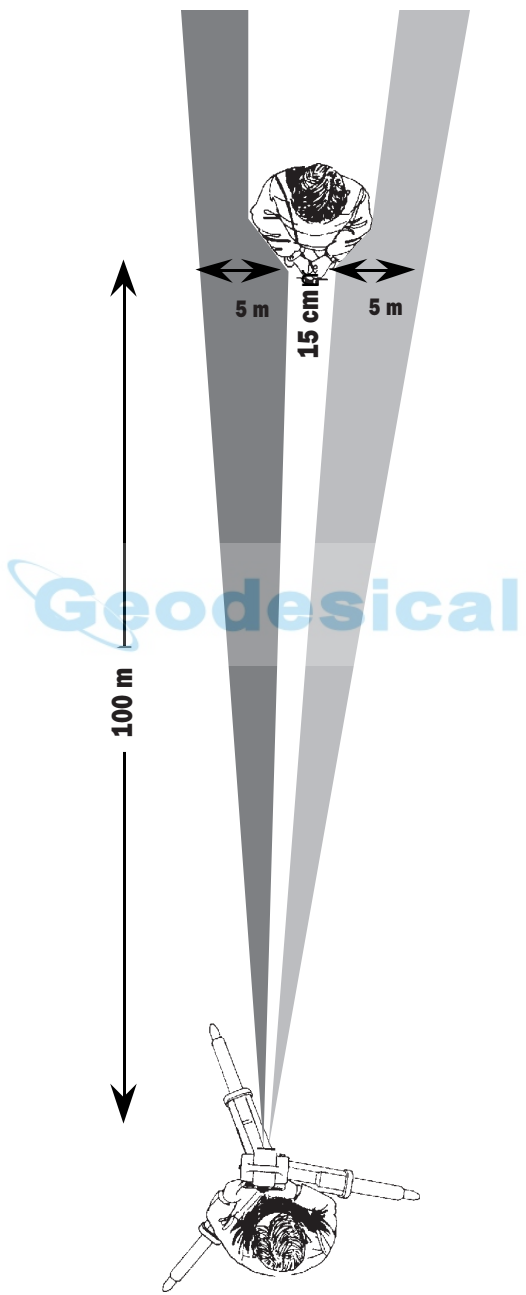

For activation of Track-light

Overview

Tracklight is a visible guide light which enables the staffman to set himself on the correct bearing. It consists of a flashing three coloured light, each colour lying within its own lateral projection sector. If the staffman is to the left of the measuring beam, he will observe a green flashing light; if to the right, a red flashing light; if on-line with the measuring beam of the instrument, a white flashing light.

The frequency of the flash will increase by 100% as soon as the light beam strikes the reflector, which will confirm for the staff - man that he/she is holding the rod in the correct position. Once the staffman is on-line, the distance will immediately appear on the display. Tracklight also provides the operator with an excellent facility for clearing sight lines and for working during the hours of darkness.

From the figure on previous page, it can be seen that the instrument measuring beam width at 100 m is 15 cm. The width of the tracklight beam at the same distance is 10 m. The tracklight unit slides onto the underside of the measuring unit (see fig 3.2 below) and it is activated from the keyboard.



Fig 3.2 The Tracklight unit slides onto the underside of the measuring unit.



Tracklight
instru-
ment



61

Tracklight
RPU

How to activate Tracklight

Tracklight is activated from the keyboard by pressing  on the keyboard unit.

The display now shows:

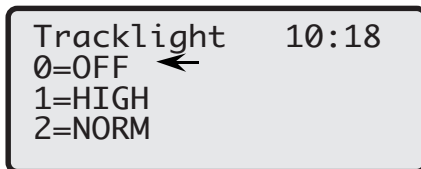
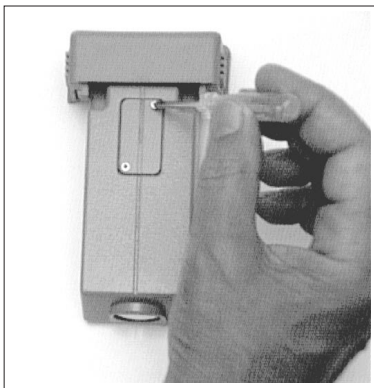

Fig 3.3 Activation of Tracklight

- Key in 0 if you wish to switch off Tracklight during measurement.
- Key in 2 if you wish to switch on Tracklight with normal light intensity.
- Key in 1 if you wish to switch on or change over to highbeam intensity during bad visibility conditions.

Tracklight is switched off automatically when the instrument is powered off. It is worth noting that the life length of the tracklight bulb will be considerably diminished if the high intensity mode is used frequently. Use this setting only during bad visibility or when the distance demands it.

Changing the bulb



In order to change the tracklight bulb, open the cover under which the bulb is situated (fig. 3.3).

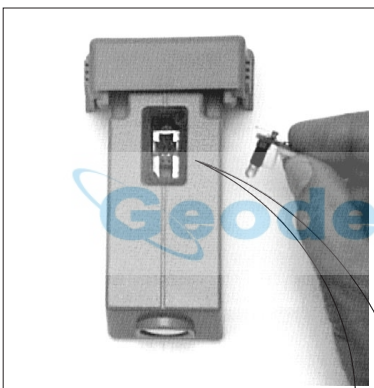

Remove very carefully the bulb housing and replace the spent bulb with a new one. Replace the bulb housing and connect the cover with the screwdriver (fig. 3.4).

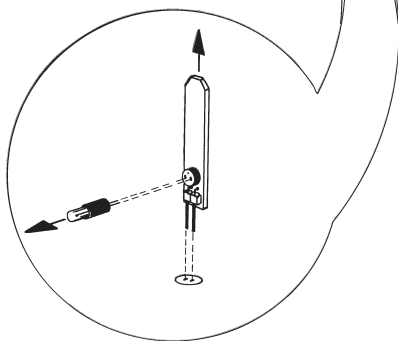

Fig 3.4 The sketch shows how the Tracklight bulb (6.3V / 0.2A) should be removed from the connection socket.

Servo

Overview	2.4.2
Servo control	2.4.2
Motion knobs	2.4.2
Servo control keys	2.4.3



Overview

The System 600 instrument can be equipped with servo-controlled motors for positioning of the unit. The servo is in use when performing a number of different operations; when turning the motion knobs, when positioning with the servo control keys, for automatic test and calibration or when using the tracker for robotic surveying.

Servo controls

Motion knobs



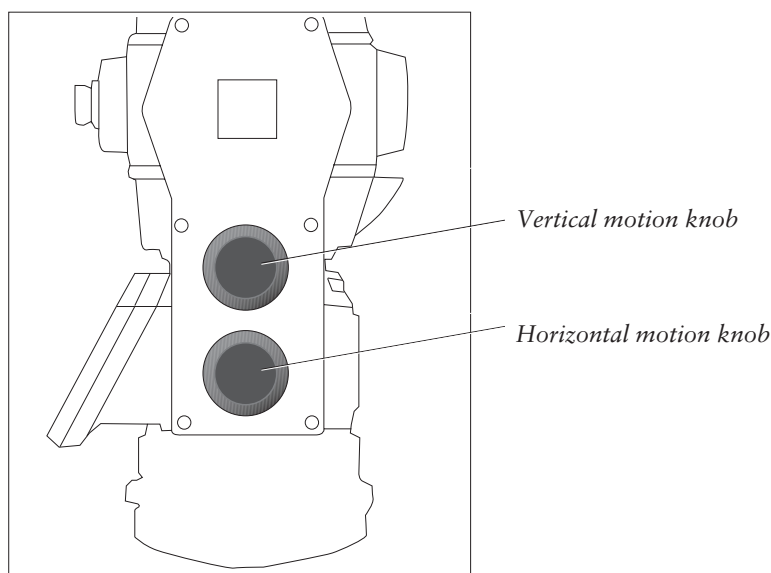

The servo is manually controlled by the two motion knobs located at the side of the instrument.

The motion knobs are sensitive in four steps so that the more you turn the knob the faster the servo will rotate the instrument.

If you want to switch to fine mode adjustment when operating a motion knob, turn the knob in the opposite direction and fine adjust.



Servo control keys

When you are about to position the instrument towards a point that are known, that is when the horizontal and vertical angle is known you can use the servo control keys  and  for positioning the instrument. Simply enter label 26 and 27 or SON and SOE and press the control key  for horizontal positioning and  for vertical positioning. As soon as the key has been pressed the servo will position the instrument at the right position.

When measuring in two faces you can use control key  for switching between face 1 and face 2.



When measuring in two faces, this key is used for switching between C1 and C2.



Key horizontal positioning



Key for vertical positioning



Key for horizontal and vertical positioning.



This key is used for switching between C1 and C2 when measuring in two faces. It is available on instruments with no keyboard unit attached at the front. A long press on this key switches the face.

 **Geodesical**

Tracker (only for servo instruments)

Overview	2.5.3
Tracker operation	2.5.3
Search Criteria	2.5.3
Lock on target	2.5.4
Controlling the tracker	2.5.4
Window control	2.5.5
Search control	2.5.6
Guidelines	2.5.7
Reference control in Robotic mode	2.5.8

Illustrations

Fig. 5.1 The Geodimeter System 600 Tracking function

Fig. 5.2 Search Routine

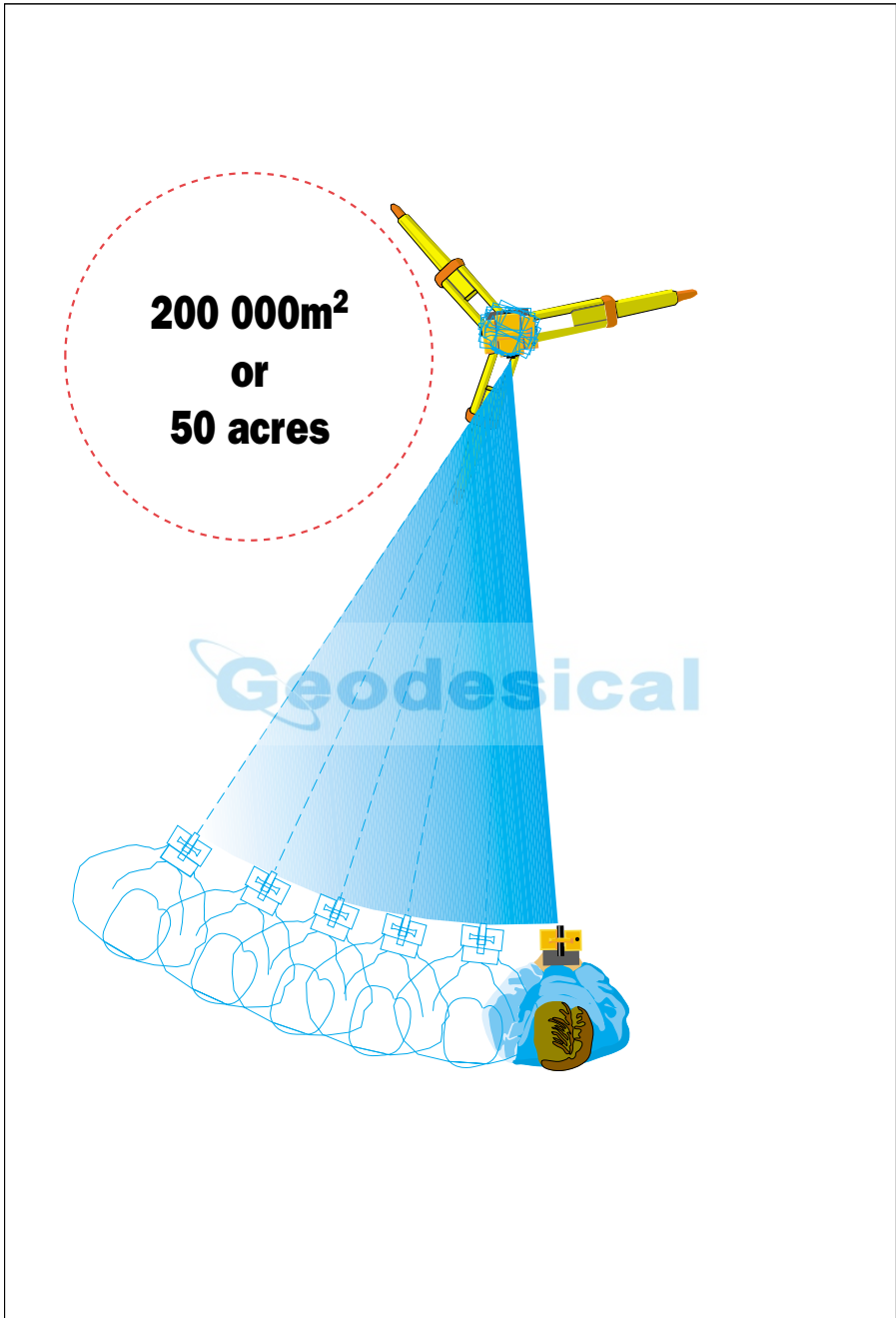

Fig 5.1 The Geodimeter System 600 Tracking function.

Overview

Geodimeter System 600 can be equipped with a Tracker unit which is needed when using the system for robotic surveying or when performing conventional surveying with Autolock™.

The tracker has control over the instrument's servos and aims the instrument correctly towards the target, which in these cases must be an RMT (Remote Target). An automatic search function is optional.

Tracker operation

Search Criteria (OPTIONAL for Autolock™)

It is possible to let the tracker make a search for the target, e.g. when measuring in dark or in heavy shrubbery where the sight is not so good or when having lost contact with the prism during a measurement.

The search is either started manually by pressing the A/M key or automatically in TRK-mode (if you have switched TRK Search ON).

The tracker seeks for the target in the following order:

- 1. ± 30 degrees horizontally around the point at which the instrument is pointing.
- 2. In a three-dimensional search window*

*** If no search window is set the search will be carried out 360 degrees around the instrument and ± 15 degrees vertically.**

Note !

If no target is found after the search Info 158 will be displayed. Reaim the RMT towards the instrument and press the A/M-key to start the search procedure.

Note !
Use the

NO

key to
cancel the
search.

Lock on target

When the instrument is locked on the RMT this is indicated by a + on the display. When moving the RMT, still visible for the instrument, the instrument will automatically follow.

If losing contact with the instrument in STD-, FSTD or D-mode

If the instrument loose visible contact with the RMT, Info 161 (Target lost) will be displayed. Aim the RMT towards the instrument and press the A/M-key to start searching (optional) or use the servo controls to regain contact. The function "Advanced lock" can also be used in these measurement modes (see page 2.5.6 for further explanation).

If losing contact with the instrument in TRK-mode

If the instrument loose visible contact with the RMT, Info 161 (Target lost) will be displayed. Use the servo controls to regain contact.

With the search option:

The tracker can be set to automatically start to seek for the RMT in the search window. The instrument searches through the whole search window, both horizontally and vertically. If the target isn't found the text "**Target lost**" appears. Press the A/M-key (optional) or use the servo controls to regain contact if you have changed the position much. The function "Advanced lock" can also be used in this measurement mode (see page 2.2.6).

Controlling the tracker (OPTIONAL for Autolock™) _____

To speed up the search routine, you can set a "window" in which the instrument should seek for the target. When setting up the instrument for remote or robotic surveying you automatically will be prompted to set a search window, but when performing conventional surveying with Autolock™, you must enter the RPU menu and choose Window control to do the same.

RPU



or

RPU

RPU
menu

Window control

You can change the search window by choosing the RPU menu, 1 Autolock and 2 Window control. There are 8 different options on this menu:

1. **Auto center** – to enable/disable the automatic centering function when the instrument loses contact with the RMT.
2. **Center** – to manually change the center of the current search window to the position where the instrument is pointing (also in height).
3. **Editor** – to manually key in the window boundaries:

```
Window 14:32
Hor: L=308 R=27
Vert:U=89 D=99
Sel Exit
```

The first line shows the horizontal angle of the left and the right boundary of the window.
The second line shows the vertical angle of the upper and the lower boundary of the window.

4. **Set** – to set a new search window:

```
Window 14:32
Aim to A
Press ENT
```

Aim to the left boundary and press ENT.

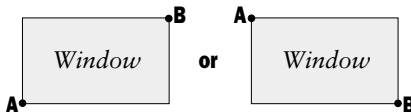

```
Window 14:32
Aim to B
Press ENT
```

Aim to the right boundary and press ENT.

5. **Reset** – to reactivate the last entered window (if you have used option 6.Remove).
6. **Remove** – to disable current search window.
7. **Left** – to change the left boundary of the current search window to the position at which the instrument is pointing.
8. **Right** – to change the right boundary of the current search window to the position at which the instrument is pointing.

Search control

In TRK-mode there are three different search options when working in Robotic mode and one (Automatic) when working in Autolock™. Choose the RPU menu, 1 Autolock and 3 Search control. The following menu appears:

```
Remote 14:32
1 Automatic: on
2 Adv.lock: off
3 RMT600TS: off
```

Toggle between on and off by pressing the corresponding numeric key. Confirm your setup by pressing ENT.

Automatic: on (in Autolock or Robotic mode)

Automatic search mode means that as soon as the instrument loses lock of the target (RMT) it will begin searching for the target 5 times in the same vertical plane (if you want to search the whole window you need to press the A/M key). As soon as the instrument finds the target it will lock on to it automatically. This function is very useful for ordinary surveying work.

Adv.lock: on (only in Robotic mode)

Advanced lock mode means that if the instrument loses lock of the target (RMT) it remains in the same direction without starting to search for the target (if Automatic is set to "off"). The instrument automatically locks on to the target as soon as it is visible again. This function is useful if you, for example, are measuring in heavy traffic with cars temporarily blocking the measuring beam. This way you save time since the instrument doesn't start searching each time the measuring beam is being blocked.

Note ! ➤

WARNING! When this switch is activated there is a risk that the instrument could lock on to a window etc. if the tracker signal should come as a reflex from the RMT. After a normal search the instrument always locks on to the strongest tracker signal which, in every case, comes directly from the RMT itself.

RMT600TS: on (only in Robotic mode and with RMT600TS)

Sometimes it can be useful to let the instrument lock on to the RMT600TS without the RMT's vertical sensor being active. This is useful if you must extend the range pole so it isn't possible for you to aim RMT600TS vertically towards the instrument.

Note ! ➤

Search mode conflict

If both Automatic and Adv.lock are set to 'on' there is a conflict. In most cases the instrument will start searching for the RMT after a beam break.



Search routine

Press A/M and the instrument will first start to search 30° horizontally around the last point, considered that the point is inside the search window. Thereafter the instrument will start to search inside the window in the way illustrated below.

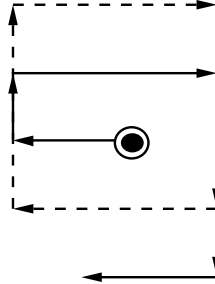

Fig. 5.2 Search routine

Note!
Use the



key to
cancel the
search.

Guidelines

Some functions are unique when you use the tracker. The system guides you through the measurement by a number of indicators on the display:

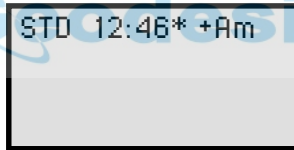

Measurement information

- * the instrument has contact with the prism.
- + the tracker has locked on the target.
- ++ the tracker has locked on the target and the angle values are frozen (STD, FSTD and D-bar modes).
- T The tracker is activated. (If search option is installed Am will be seen instead).



A/M-key (optional for Autolock™, standard for Robotic)

Am – If you press the A/M key at this moment, the tracker will start searching.

aM – If you press the A/M key at this moment, you will initiate a measurement.

A long press on the A/M-key will change between the two modes.

RPU



or

RPU



and

Reference
Control

Reference Control in Robotic mode

When setting up the instrument for robotic surveying (see chapter 1.5) you can define a reference object which is marked with a remote target. By doing this you can eliminate angular errors caused by tripod turning.

By using RPU menu 14 you can, whenever you want during the survey in robotic mode, check the reference object bearing and automatically compare the measured bearing with the original and if you want adjust it.

```
Robotic 14:32
```

```
Measuring RefObj  
Please Wait
```

The instrument located the reference object and measures towards it 5 times in both faces.

```
Robotic 14:32  
Coll.adjusted  
TotdH: -0.0050  
Adjust HA REF?
```

The difference between the original HAref and the measured is presented as dH. Press YES or ENT to adjust the bearing or NO to ignore.

- The reference object does not have to be located at a known point but should be located outside the search sector and preferably at a distance longer than 100m.
- Don't change label 21 because this will also change the angle to the reference object.
- If you choose MNU 33 (Fetch Station data) the original HA will be used, and a reference control measurement will be made automatically.
- If the reference object is obstructed when choosing RPU menu 14 you will get INFO 158 (Can not find the target).
- If the reference object is obstructed during the reference control you will get INFO 161 (The target is lost) and the measurement is cancelled.
- If the reference object is located inside the search sector it is possible that the instrument locks on the reference object instead of on the RMT. In that case the system will automatically continue to search after the correct RMT.

Radio

Overview	2.6.3
Radio controls	2.6.3
Radio channel selector	2.6.3
Station address	2.6.3
Radio license	2.6.3
Radio contact	2.6.4
Range	2.6.4
Info codes	2.6.4
External radio	2.6.5

Illustrations

- Fig. 6.1 The Geodimeter System 600 with radio side cover
- Fig. 6.2 External radio - top view
- Fig. 6.3 External radio - left view
- Fig. 6.4 External radio - right view



Fig 6.1 The Geodimeter System 600 with radio side cover.

Overview

To be able to communicate between the instrument and the RPU the instrument must be equipped with a radio side cover and the keyboard unit must be connected to an external radio. The radio side cover consists of a built in radio and an antenna.

Radio controls

MNU**1****5**

Select radio channel

The radio channel is selected from menu 15. Up to 12 channels can be used depending on how many are supplied or permitted by authorities in each country. Select a channel using the <- (arrow) key when the keyboard is attached to the instrument. Then, when the keyboard unit is detached and connected to the external radio, this radio will automatically get the same channel as the instrument. The range of different channels makes it possible to work with more than one Geodimeter System 600 at a working site. It is though important that each system has its own radio channel so that not any disturbances will occur.

Station address

If disturbances occur on the radio channel from other systems in the same area, try to change channel. If that does not help the instrument and the RPU can be given an unique address. Choose menu 15, Radio with the keyboard unit attached to the instrument. Here you are prompted to enter a station address and a remote address between 0 and 99.

Radio license

Before using the system at your working site it is important to notify that in some countries it is necessary to have a user license. Make sure that your Geodimeter agent has informed you about the regulations in your country.

RPU



or

RPU



*Note !
If you've powered off the system from the RPU, the system will store all parameters for 2 hours. Restart simply by pressing PWR at the keyboard.*

Radio contact

You can establish contact between the RPU and the instrument in two ways:

1. Start the instrument with an attached keyboard unit

- a. Choose a channel and an address with menu 15 if it's the first time you establish contact.
- b. Press the RPU-key.
- c. Choose 3. Remote and follow the instructions.
- d. The instrument will prompt "Press any key, Remove keyboard".
- e. Remove the keyboard, connect it to the external radio and press the PWR button.

2. Start the instrument with the A/M-button

With this method you don't have to attach the keyboard unit on the instrument.

- a. Press the A/M button on the backside of the station unit, one beep will be heard.
- b. 2 beeps will be heard when the radio is on.
- c. Press the PWR button at the detached keyboard unit.

Note !

To be able to establish contact between the instrument and the RPU by using method 2, you must have established contact using method 1 at least once before, since the external radio must get the correct radio channel from the instrument.

Range

The actual range in which the radio can work is depending on the conditions. Other radios that may be in operation in your area can decrease the range as well as when working in an area with many reflecting objects.

Info codes

If the radio contact between the RPU and the instrument can not be established info code 103 will be displayed. If this appear, first check that both units are switched on and setup

properly, that no other radio is working on the same channel, then restart both units and retry. If still no radio contact can be established, contact your local Geodimeter Service shop for support.

If the radio contact between the RPU and the instrument is disturbed e.g. by another radio info code 30 or 107 may be displayed. If this appear, try to change channel.

Note !

If the radio battery is in a bad condition when you start the system from the RPU, the system might need to be restarted, i.e. station establishment etc. might have to be done again.

External radio

The external radio is connected to the keyboard unit with the system cable. The PWR button on the radio unit is not necessary to use since the keyboard unit automatically turns the radio unit on at startup. If you connect the keyboard unit to the wrong connector on the radio, the keyboard unit automatically obtains local mode.

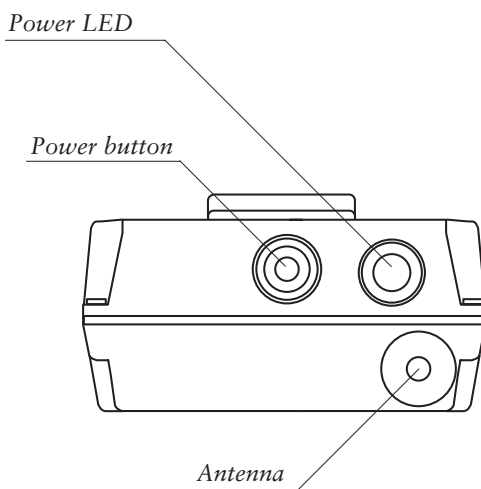



Fig 6.2 External radio - top view

Note !  The radio battery must be disconnected from the radio before connecting the charger.

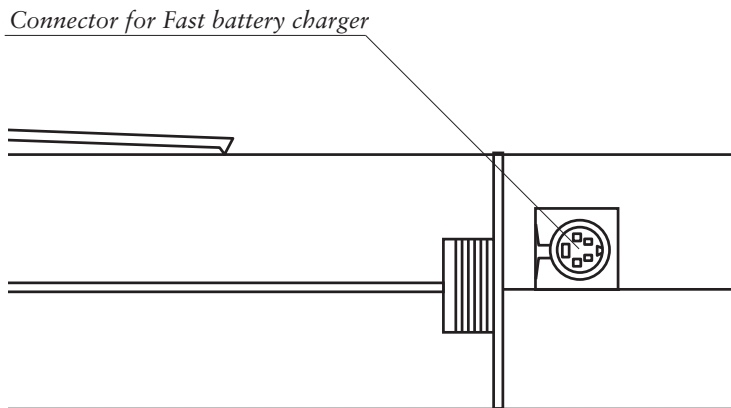

Fig 6.3 External radio - left view

Geodesical

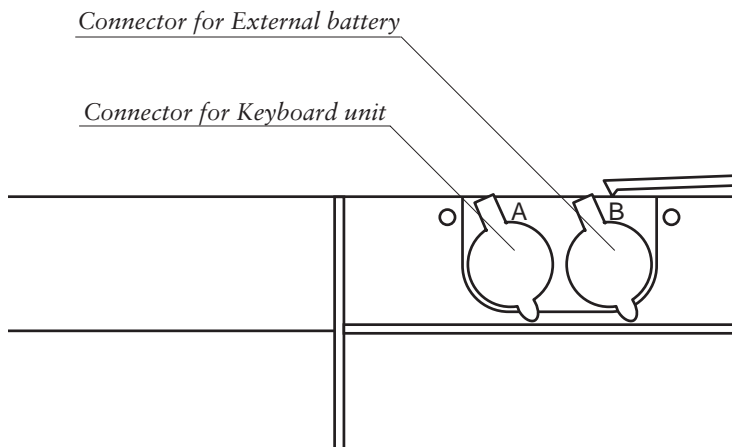

Fig 6.4 External radio - right view

Data Logging

Data Recording _____	2.7.2
Control of Data Registration _____	2.7.3
Data Output _____	2.7.3
Standard Output _____	2.7.3
User Defined Output _____	2.7.5
How to Create Output Table _____	2.7.6
Type of Memory Device _____	2.7.8
Imem _____	2.7.8
Serial _____	2.7.9
Xmem _____	2.7.14
Data Communication _____	2.7.15
Keyboard unit - Personal Computer _____	2.7.15
Instrument with Keyboard unit - Personal Computer _____	2.7.16
Keyboard unit - Instrument with Keyboard unit _____	2.7.16
Instrument with Keyboard unit - Card Memory _____	2.7.17
Card Memory - Personal Computer _____	2.7.17
Program 54 - File transfer _____	2.7.18

Data Recording

The recording of data when using Geodimeter System 600 is based on the general system of labels and label numbers which describe the different data items. The system has 109 different labels, which all can be registered as separate items directly from the keyboard of the instrument, or they can be recorded using the User Definable Sequences available in the additional software (UDS).

Angle registration can be carried out during both single and double face measurements.

The angle values are measured in face II by pressing the A/M-key and can then be displayed and recorded in the face I position. In this case angle recording is carried out under separate labels for face I and face II. Instrument data can be recorded according to tab 7.1 (see below).

Data is always stored in the keyboard unit attached at the back, even if two keyboard units are attached.

If you wish to store data in both panels, you will have switch keyboard units. Data can also be transferred as a file between two keyboard units (Program 54).

Tab 7:1
Data for
recording.

Instrument Data	Prompt	Label
Horiz. Angle	HA	7
Vert. Angle	VA	8
Horiz. Angle C2	HA II	17
Vert. Angle C2	VA II	18
Horiz. Angle C1	HAI	24*
Vert. Angle C1	VAI	25*
Horiz. Diff.	dH	16*
Vert. Diff.	dV	19*
Slope Dist.	SD	9
Horiz. Dist.	HD	11
Diff. in Height	dHT	10
Vert. Dist	VD	49
North. Coord.	N (X)	37
East. Coord.	E (Y)	38
Elev. Coord.	Ele (Z)	39
Rel. Coord. North.	Xr	47
Rel. Coord. East.	Yr	48

* Only in D-bar. Normally C1 angles is read in label 7 and 8. But in D- bar label 7 and 8 is the allover mean value.

Control of data registration

The instrument checks the validity of data before recording. It checks, for instance, that the instrument is on target. This can be deselected with Targ. test off? MNU 61 - i.e. that measured angles and distances correspond to each other and that a measured distance is not recorded twice. For more information about eccentric objects, see "yellow pages" 2.2.7.

Data Output

MNU

4

A standard table for output is set for each measurement mode of the instrument. If a different output is required, 5 additional output tables can be specified by the user directly from the keyboard. This is done with MNU 42, Create table function.

The choice of the type of recording device that shall be used for the transfer of the data - e.g. Internal memory on the instrument or Serial for direct transfer via the tribrach contact to and from a computer - is done with MNU 41, Select device function.

*Note! ➤
A complete list of Function and labels can be found in Appendix A.*

Different output tables or the same one can be activated for more than one device simultaneously.

Standard output

Output of measured data from Geodimeter System 600 can be set completely independently of the displayed data. The standard output tables have been set for recording horizontal angle, vertical angle and slope distance for the different measuring modes. If output of other data is required, special output tables can be set by the operator. The standard output, Table 0 (see tab. 7:2, page 2.7.4), is adapted to the function of the different modes of measurement, while a User Defined Table 1, 2, 3, 4 and 5 will be independent of choice of mode.

Tab 7:2
Table 0
Standard
Mode,
STD

STD mode One-face (C1)		STD mode Two-face (C2)		
Prompt	Label	Prompt	Label	Comments
HA	7	HA	7	Horiz. Angle C1
VA	8	VA	8	Vert Angle C1
SD	9	SD	9	Slope Dist.
		HA II	17	Horiz. Angle C2*
		VA II	18	Vert Angle C2*

*Not available at the RPU

The above data can be recorded when measuring in standard mode (STD) in selected memory device.

Note! In theodolite-mode only label 7 & 8 will be registered. Table 0, 1, 2, 3 and 4 are only available after a distance measurement.

Tracking mode (TRK)

In tracking, measurement and recording can be made only in the face one position. Recording follows the procedure of one-face measurements in the Standard mode as described above.

D-bar mean value mode

In D-bar measurements recording can be done according to table 7:3 (see following page). After two-face measurements the reduced mean value of the angles from the two faces (C1/ C2) can be recorded with labels 7 and 8, the mean angular value for angles in C1 are recorded with labels 24 and 25, and the mean angular value for angles in C2 are recorded with labels 17 and 18. A mean value of the slope distance (SD) will also be recorded with label 9.

D-bar mode One-face (C1)		D-bar mode Two-face (C2)		
Prompt	Label	Prompt	Label	Comments
HA	7			Horiz. Angle
VA	8			Vert. Angle
SD	9			Slope Dist. Mean value
		HA	7	Mean value of angle sightings, corrected for difference between C2 and C1.*
		VA	8	
		HA II	17	Mean value for sighting in face 2 (C2).*
		VA II	18	"-"
		HA I	24	Mean value for sightings in face 1 (C1).*
		VA I	25	"-"
		SD	9	Slope distance mean value

Tab 7:3 Table 0, D-bar.

**Only at the instrument*

User defined output

If the standard output, Table 0, is not suitable, five user defined output tables, Tables 1 to Table 5, can be set up by entering the required labels from the keyboard.

The output table can contain any data measured or calculated by the instrument - e.g., reduced distance or coordinates. Time and date are updated in the instrument and can be recorded. Other data such as Point Number and Point Codes can also be included in the output table. However, each corresponding data value must then be updated using the function key.

MNU

How to create an output table

4

```
STD P0 10:16
HA: 234.5678
VA: 92.5545
```

To be able to create a new output table, you must first choose function 4 ("Data com") of the menu.

2

MNU

4

```
Data com 10:16
1 Sel. device
2 Create table
```

Select number 2, "Create table".

2

```
Data com 10:16
Table no=
```

Select table number = (1,2,3,4,5) and then press ENT.

ENT

```
Data com 10:16
Label no=
```

Select desired label – e.g., HA = label 7. Press ENT.

ENT

Note - Table 5 !

No measured or calculated distances can be stored in table 5.

Note! ➔ A complete list of Functions and labels can be found in Appendix A.

See following page

MNU

4

2

How to create an output table (Cont.)

Data com 10:16
HA
Ok?

The label is confirmed or rejected with YES or NO. Press YES or ENT.

ENT

Data com 10:16
Label no=

The question "Label no=" will be repeated until all required labels have been entered. When arriving at the end of selection of labels, answer by only pressing ENT. The display returns to program 0.

ENT

Program 0

Note! ↗

User defined output tables can only be activated and used in combination with fully completed measurement cycles which must include distance measurement.

Output table 5 - when you wish to exclude distances

With output table 5 you can use a display table that contains angles or other labels that do not have distances or coordinates.

MNU

Type of memory device

Selection of memory device can be made with menu function 4, option 1, "Select device".

4

The following choices are available:

1

```

Data com 10:16
1 Imem
2 Serial
3 Xmem
    
```

Press 1 to select the internal memory or 2 to select the serial interface connection. (This is the display that shows when there is no card memory or when it is connected via the foot connector).

1

2

3

Imem

Serial

Xmem

This is the display when the card memory is connected on the backside of the instrument.

```

1 Imem
4 Card
    
```

MNU

1. Internal memory

Select MNU 411, for recording to the Internal Memory. See more about the internal memory in the "Software Manual".

4

The setup procedure contains the following display instructions:

1

1

```

Imem      10:16
Imem ON?
    
```

YES to continue, NO to interrupt. Press YES or ENT.

ENT

```

Imem      10:16
Table no=
    
```

Select output table number = 0,1,2,3,4 or 5 and then press ENT.

ENT

See next page

MNU

4

1

1

From previous page



Imem 10:16
REG key?

Control of the output can be done by pressing the REG key of the instrument (REG-key?) or continuously (Slave?). Choice of method is made by answering Yes to one of the following questions: REG-key? or Slave?.



MNU

4

1

2

2 Serial output

Select MNU 412 for output to external computer equipment via the serial interface connection. Setting the communication is done by following the instructions in the display and answering via the keyboard.

Serial 10:16
Serial ON?

Connected device switched on or off?
Press YES or ENT to continue.

ENT



See next page

- MNU
- 4
- 1
- 2

2 Serial output (Cont.)

Serial 10:16
COM=1.8.0.9600

Transmission parameters. The parameter setting can be accepted by just pressing ENT, changed completely by overwriting from the beginning, or changed by erasing each character using the <- key.

The four transmission parameters which are separated by decimal points can have the following values:

- Pos. 1: Number of stop bits=1
- 2: Number of data bits 7 or 8
- 3: Parity: No parity = 0
Odd parity = 1
Even parity = 2

Pos. 4: Baud rate: 50–19200 baud standard rates, e.g 300, 1200, 2400, 4800, 9600, 19200.

ENT

Serial 10:16
Table No=

Select output table number = 0,1,2,3,4 or 5 and then press ENT.

ENT

Serial 10:16
REG key ?

Control of the output can be done 1) by the computer, 2) by pressing the REG-key of the instrument (REG key?) or 3) output can be continuous (Slave?). Choice of method is made by answering YES to one of the following questions: REG Key? or Slave?



Serial commands

If neither REG-key or Slave is selected, data output is initiated from the computer by sending one of the following commands. The command is executed upon the carriage return. See the "Software and Data communication" manual for a complete list of the serial commands.

Load

Load Memory. Data according to the standard format can be loaded into the memory device.

Syntax: L<dir>=<file>
 <dir>: 'I' The Area directory
 'M' The Job directory
 'U' The U.D.S. program directory
 <file>: Is the name of the file (max 15 characters). The file name is case sensitive.

Output

Output from memory

Syntax: O<dir>=<file>
 O<dir><arg>
 <dir>: 'I' The Area directory
 'M' The Job directory
 'U' The U.D.S. program directory
 <file>: Is the name of the file (max 15 characters). The file name is case sensitive.
 <arg>: 'C' Output of the file catalog

Read

Read Instrument of measured data or data in specific labels

Syntax: RG=[<arg>][,<lbl>]
 <arg>: [S] Standard output
 N Name output
 D Data output
 V Numeric output item by item
 T Test if signal from target. 300 is returned if no signal. 301 is returned if signal.

Trig

Start of distance measurement in instrument.

Syntax: TG[<arg>]

<arg>: '<' This is default and need not to be entered.

Write

Write data into instrument. All labels that can be set by the function key in the system can be written.

Syntax: WG,<label>=<data>

<label>: 0-109

<data>: Maximum 9 digits for numeric type labels and maximum 16 characters for ASCII type labels.

When **"REG-Key"** is selected data corresponding to the actual output table will be transmitted when the REG-key is pressed.

The **"Slave"**-mode setting means that data are automatically transmitted every time an instrument measurement is completed without needing to press the REG-key.

Hardware connection serial (RS-232/V24)

Use the multifunctional cable (Part no 571 202 188/216) together with the computer adapter (Part no 571 202 204) to connect the Keyboard unit to a computer via the external battery (Part no 571 202 194) or power supply.

Pin	Signal
2	Data in (RXD)
3	Data out (TXD)
7	Ground (BATT-)
8	12 V (BATT+)

Tab. 7:5 Computer connection configuration

Value	Description
0	Instrument operating correctly, all required data are available.
3	The measured distance has already been recorded. A new distance measurement is required.
4	Measurement is invalid and recording not possible.
5	Recording is not possible with the selected mode setting of the Geodimeter instrument.
20	Label error. This label cannot be handled by the instrument.
21	Parity error in transferred data (between Geodimeter and interface).
22	Bad or no connection, or wrong device connected.
23	Time Out
30	Syntax error.
35	Data error.

Tab 7:4 Status Description

Output format.

The standard format of data from the interface is:

< Label > = < data > CRLF

Status

Status is a numeric value, transmitted before measurement data, and indicates those values which are about to be transmitted. This status value is non-zero if an error is detected. See table 7:4 for status description.

End of Transmission

The end of transmission, EOT, character is set in label 79, where the equivalent ASCII number is set. (Default is 62, e.g ">"). If set to 0 no EOT will be sent.

MNU**4****1****3****3 Xmem**

Select MNU 413 for output to the Geotronics card memory if it is attached to the panel on the back of the instrument.

The setup procedure contains the following display instructions:

Xmem 10:16
Xmem ON?

*YES to continue, NO to interrupt.
Press YES or ENT.*

ENT

Xmem 10:16
Table no=

*Select output table number=0,1,2,3,4
or 5 and then press ENT.*

ENT

Xmem 10:16
REG key?

*Control of the output can be done by
pressing the REG key of the instru-
ment (REG key?) or continuously
(Slave?). Choice of method is made by
answering YES or ENT to one of the
questions.*

ENT

Data Communication

Geodimeter System 600 can be connected to an external device via a built in serial interface (RS-232) as described on the previous pages. This part of the manual will describe how to transfer data from and to the Geodimeter instruments.

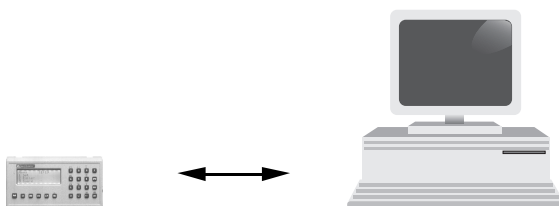

Keyboard unit

Personal Computer

Connect the Keyboard unit and the computer to a battery via the multifunctional cable 571 202 188/216 and the computer adapter 571 202 204 and turn on both units. There are two ways to transfer data between these units:

1. Program 54 (not for Card Memory-PC)

Enter program 54 at the Keyboard unit and choose (From Imem, To Serial) to transfer files from the Keyboard unit to the computer or choose (From Serial, To Imem) to transfer files in the other direction. In the second case the transfer is initiated by copying the file from the computer to the communication port. See more about program 54 on page 2.7.18.

2. RS-232 commands

By sending the appropriate commands from the computer you can transfer data between the Keyboard unit and computer. Look at page 2.7.10 for a list of serial commands or see the Geodimeter Software & Data communication manual for further information.

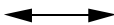

Instrument with Keyboard unit
Personal Computer

Connect the instrument's tribrach contact and the computer to a battery via the multifunctional cable 571 202 188/216 and the computer adapter 571 202 204 and turn on both units. Then follow the Keyboard unit-Personal Computer instructions for file transfer between the two units.

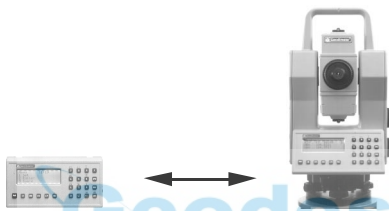

Keyboard unit
Instrument with Keyboard unit

Connect the instrument's tribrach contact and the Keyboard unit via the cable 571 202 188/216. Turn on both units and enter program 54. First choose (From Serial, To Imem) at the unit that are to receive data then choose (From Imem, To Serial) at the unit that are to send data. See more information about program 54 at page 2.7.18.

Note !

Do not connect the Keyboard unit to the External Radio (571 180 810) through the T-connector (571 202 312) when an external battery is already connected to the T-connector, as this will destroy the battery. When the Keyboard unit and the External Radio are to be connected, the internal battery inside the radio should be the only power source.

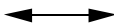

Instrument with Keyboard unit
Card Memory

Connect the instruments tribrach contact and the Card Memory via the cable 571 202 188/216. Turn on the instrument and enter program 54. Choose (From Xmem, To Imem) if you are going to transfer data from the Card memory to the instrument or (From Imem, To Xmem) if you are going to transfer data from the instrument to the Card memory. See more information about program 54 at page 2.7.18.

Card Memory
Personal Computer

Connect the Card Memory and the computer to a battery via the multifunctional cable 571 202 188/216 and the computer adapter 571 202 204 and turn on the computer. There is one way to transfer data between these units:

RS-232 commands

By sending the appropriate commands from the computer you can transfer data between the Card Memory and computer. Look at page 2.7.10 for a list of serial commands or see the Geodimeter Software & Data communication manual for further information.

PRG

Program 54 - File transfer

54

Connect the two units with the appropriate cable and switch them on. The instructions below describes how to transfer files from the Keyboard unit to the keyboard unit attached on the instrument.

Operation at the source unit (Keyboard unit)

MNU 54

Choose program 54

From 16:12
 1. Imem
 2. Serial
 3. Xmem

*Choose from which device you want to transfer files.
 In this example we choose 1 Imem.*

1

File 16:12
 1. Job
 2. Area
 3. U.D.S.

*Here you can choose what type of file you want to transfer:
 1. A jobfile 2. A areafile or 3 An U.D.S-file. In this example we choose 1. A jobfile.*

1

16:12
 Job=

*Key in the name of the file.
 In this example we key in Job=1*

1

See next page

PRG

54

From previous page

```
To      16:54
1. Imem
2. Serial
3. Xmem
```

To which device are you going to send the chosen file/s from the source unit.
Here we choose 2. serial.

2

```
P54 16:54
COM=1.8.0.9600
```

Enter new serial parameters or accept the current.
Here we accept the current with enter.

Note! ←

ENT

```
P54 16:54
Wait
```

Note !
Prepare the target unit before accepting the serial parameters for a successful file transfer.

The file/s are sent via the cable and the display shows "Wait" during the transfer and you will then exit program 54.

Note! ←

Note - Info 19

If Info 19 appears during a file transfer that means that the file transfer was not successful. In that case you should run the file transfer again and look for where it fails, that is when Info 35 (Data error) will show. Then check your file for any errors and if possible correct them with the editor.

PRG

Operation at the target unit (Instrument with keyboard unit)

54

PRG

Choose program 54

54

From 16:12
 1. Imem
 2. Serial
 3. Xmem

From which device are you going to send files to the target unit. In this case it is 2. Serial.

2

P54 16:54
 COM=1.8.0.9600

Enter the serial parameters which must be same as the serial parameters at the source unit. In this example we accept the current with ENT.

ENT

To 16:54
 1. Job
 2. Area
 3. U.D.S.

What type of file should the transferred files be saved as: 1. Job, 2. Area or 3. U.D.S. In this example we choose 1. Job since we are transferring a Jobfile.

1

To 16:54
 Wait

The unit is now ready to receive the transferred files. Now you should start the transfer from the source unit.

Power Supply

Batteries	2.8.2
Internal Battery unit (Central unit)	2.8.2
Internal Battery unit (Battery side cover)	2.8.2
External Battery/Radio Battery	2.8.2
Single Adapter	2.8.3
Multi Adapter	2.8.3
Battery Cables	2.8.3
Battery Charging	2.8.4
Chargers	2.8.4
Power Unit	2.8.4
About charging NiMH (and NiCd) batteries	2.8.5
Function Bat Low	2.8.5
Battery status	2.8.6

Geodesical

Illustrations

- Fig. 8.1 Internal Battery (central unit), 12V
 Fig. 8.2 Internal Battery (side cover), 12V
 Fig. 8.3 External Battery/Radio Battery, 12V, 7Ah

Batteries

Internal Battery unit (Central unit)

The internal NiMH 12V, 1.6 Ah battery unit (Part No. 571 202 460) or NiCd 12V, 1.2 Ah battery (Part No. 571 200 320) slides into the underside of the measuring unit.

These are the standard batteries for the measuring unit.

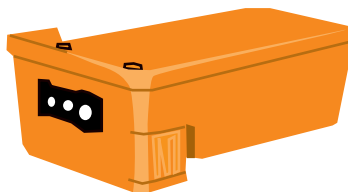

Fig 8.1 Battery unit, 12V, for central unit

Internal Battery unit (Battery side cover)

The internal battery unit for the battery side cover is of the same type as the internal battery for the central unit: 12V, 1.6 Ah NiMH (Part No. 571 202 880) or 12V, 1.2 Ah NiCd (Part No. 571 202 150).



Fig 8.2 Battery unit, 12V, for side cover

External Battery/Radio Battery

The external NiMH 12 V, 3.5 Ah battery (Part No. 571 204 270), which is also common to other Spectra Precision products, is connected to the instrument via the Single Adapter (Part No. 571 204 256) or Multi Adapter (Part No. 571 204 273) described below and a standard Hirose cable. The battery also fits directly on the External Radio.

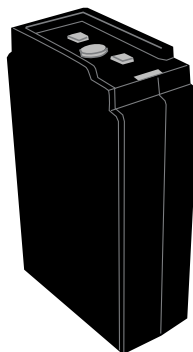

Fig 8.3 External Battery/ Radio Battery, 12V, 3.5 Ah

Single Adapter

The Single Adapter (Part No. 571 204 256) is used when you want to connect the External NiMH Battery (Part No. 571 204 270) to the Geodimeter instrument via a standard Hirose cable. The adapter slides onto the upper side of the External Battery. The adapter has two Hirose contacts and a bracket for attaching it to a tripod.

Multi Adapter

The Multi Adapter (Part No. 571 204 273) is used to connect up to three External NiMH Battery units (Part No. 571 204 270) to the Geodimeter instrument via a standard Hirose cable. The adapter slides onto the upper sides of the External Batteries. The adapter has 2+2 Hirose contacts and a bracket for attaching it to a tripod. Three External Batteries will result in a total capacity of 10.5 Ah!

Battery Cables

The multifunctional cable is required if an external battery is used or when connecting the different Spectra Precision devices with each other. The different types of cables are listed below:

Multifunctional Cable 1m, 571 202 188, for connecting the Geodimeter instrument or control unit to an external battery via the Single or Multi Adapter or to another control unit or instrument. Length: 1.0m.

Multifunctional Cable 2.5m, 571 202 216, same as the above cable. Length: 2.5m.

Multifunctional Cable 0.4m, 571 208 043, same as the above cable. Length: 0.4m.

Data Communication Adapter, 571 202 204, for connecting the Geodimeter instrument or control unit to a computer and a Power Supply or an external battery using the Single or Multi Adapter.

Battery Charging

Spectra Precision AB produces special NiMH and NiCd battery chargers which should always be used when charging Geodimeter batteries.

The system contains the following different types of units:

Single Charger (571 906 214)

A 230 or 115 VAC single battery charger. The charger has a single Hirose output that can handle one NiMH External Battery (571 204 270) or one NiCd 7 Ah battery (External heavy duty battery 571 202 194). Use together with Power Cable 571 908 050 (100-115V), 571 908 051 (230V) or 571 908 052 (230V, UK plug) and Charger Cable 571 208 018 (for the 7Ah battery) or 571 208 020 (for other batteries).

Super Charger (571 906 145)

A microprocessor controlled charger for sequential charging of up to four Spectra Precision NiMH or NiCd batteries. It is run with 10-30VDC and is fitted with a connector to suit both 19mm and 12mm cigarette lighter sockets. It shall only be used together with Spectra Precision's Power Unit (571 906 146). The ambient temperature while charging should be between $\pm 0^{\circ}\text{C}$ and $+40^{\circ}\text{C}$. Use together with Charger Cable 571 208 018 (for the 7Ah battery) or 571 208 020 (for other batteries).

Note! 

WARNING!!! The Super Charger is for use together with Power Unit 571 906 146 only! Other power units or charging converters must never be used together with Super Charger.

Power Unit (571 906 146)

A 90-260 VAC charging converter for use together with Super Charger (571 906 145). The Power Unit is equipped with a cigarette lighter socket and two Hirose connectors for Geodimeter system cabling. Use together with Power Cable 571 905 924 (230V), 571 905 925 (100-115V) or 571 908 040 (230V, UK plug).

About charging NiMH (and NiCd) batteries

Charging time for a discharged NiMH (or NiCd) battery is approximately 14-16 hours (considerably shorter using Super Charger). The temperature while charging should be above +5°C but should not exceed room temperature (0 to +40°C for Super Charger). The condition of the battery will be better preserved if it is used until the Geodimeter indicates "Bat Low" and the automatic cut-out function is activated. Discharge of stored batteries can vary considerably, depending on the quality of the individual cells, especially at higher temperatures. It is therefore recommended to recharge batteries if they have been stored for a longer period than two weeks.

Bat Low

When battery capacity drops too low, "Bat Low" appears in the display window, and the instrument shuts off automatically. This gives you an opportunity to change the battery without losing instrument parameters and functions such as instrument height, signal height, coordinates, bearing, dual axis compensation, etc. Note that the battery change must be made within 2 hours; otherwise the above parameters and functions will be reset.

Note!

This safety backup of the instrument's parameters and functions will work only when "Bat Low" appears on the display. It will not function if the battery is removed during operation.



Battery Status

A battery symbol is shown in the display to indicate the status of the battery power. A filled symbol indicates a good remaining capacity of the battery while an empty symbol indicates low remaining capacity. For some keyboard models the battery status indication is numerical (5 down to 0). However there are some remarks to be made:

- The discharge curve for NiCd and NiMH batteries may vary a lot with the condition of the battery. Because of this the time between a fully charged battery and battery low will vary between a brand new battery and an old one. It will also vary depending on what charging method has been used and of which type the battery is.
- A battery which is taken directly from the charger may show a full battery symbol even if it is not fully charged.

From this we recommend you to note the following:

Note !

- **The battery status should be considered only as a coarse indication of the connected battery's remaining capacity.**

Definitions & Formulas

Corrections for:

Curvature error _____ 2.9.2

Refraction error _____ 2.9.2

Corrections for:

Difference in height _____ 2.9.3

Horizontal distance _____ 2.9.4

Instrument Height _____ 2.9.4**Signal Height** _____ 2.9.4**Atmospheric Correction (PPM)** _____ 2.9.5

Corrections for Refraction and Curvature

If projected distances and heights are computed by only multiplying the measured slope distance respectively by the sine and cosine of the measured zenith angle, the errors can be considerable due to the earth's curvature and refraction. The two formulas which are used in the instrument for the automatic calculation of curvature and refraction errors can be seen below. If working at great heights these error factors can be calculated manually. It must be pointed out, that local values of R_e and K will vary, depending on the geographical location of the survey area.

$$DHT = SD \times \cos Z + \frac{(SD)^2 \times \sin^2 Z}{2 R_e} \quad (1 - K)$$

$$HD = SD \times \sin Z - \frac{(SD)^2 \times \sin 2Z}{2 R_e} \quad (1 - K/2)$$

HD = Horizontal Distance, DHT = Difference in Height,
 SD = Slope Distance, R_e = Earth radius mean value = 6372 km
 K = Refraction constant mean = 0.142

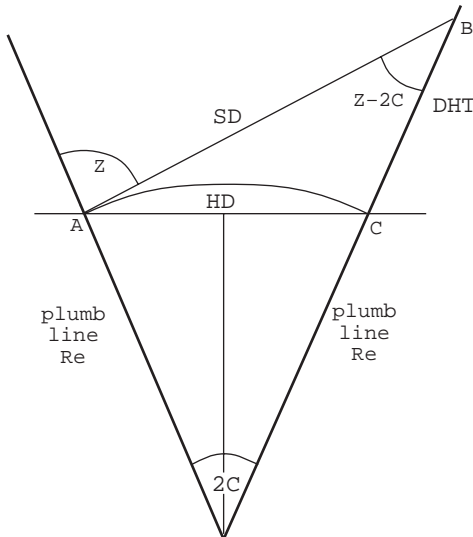

Correction for difference in height

Case 1:

Slope distance has not been corrected when displayed or recorded.

Case 2:

If different values of K and /or R_e are used, adjust accordingly to the formula's standard values, which can be seen on the previous page; these values can normally be obtained from the local Ordnance Land Survey Authorities.

Example

Correction for the difference in height when close to the horizontal plane.

Correction (mm)

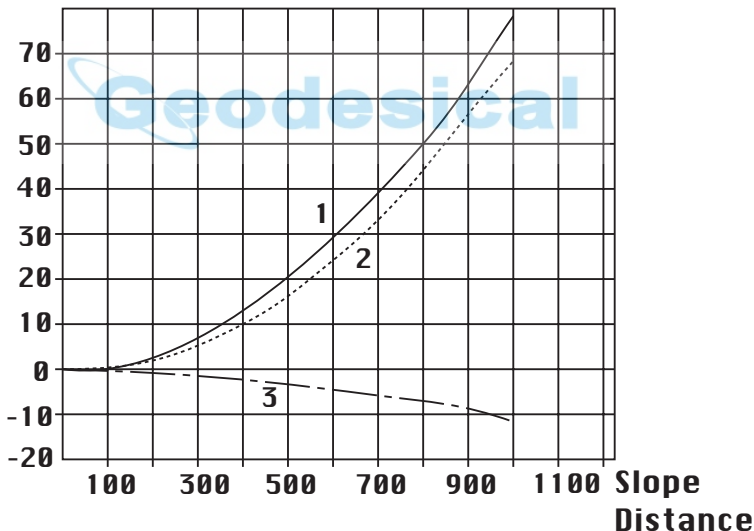

Curve 1 represents the earth's curvature. Curve 3 is the correction for refraction as a function of slope distance. Curve 2 is the resultant correction to be applied to the height obtained by multiplying the slope distance by $\cos z$. This correction changes relatively slowly in relation to the deviation from the horizontal plane. At $20g$ ($Z=80g$), the corrections will have decreased 10%.

Correction of horizontal distance

The correction for the earth's curvature and refraction that has to be applied to the horizontal distance which has been obtained by multiplying the slope distance by sine Z follows the curve shown in the figure below. The correction is proportional to the square of the slope distance and approximately directly proportional to the deviation from the horizontal plane for moderate elevations.

Example:

Correction of the horizontal distance.

Correction (mm)

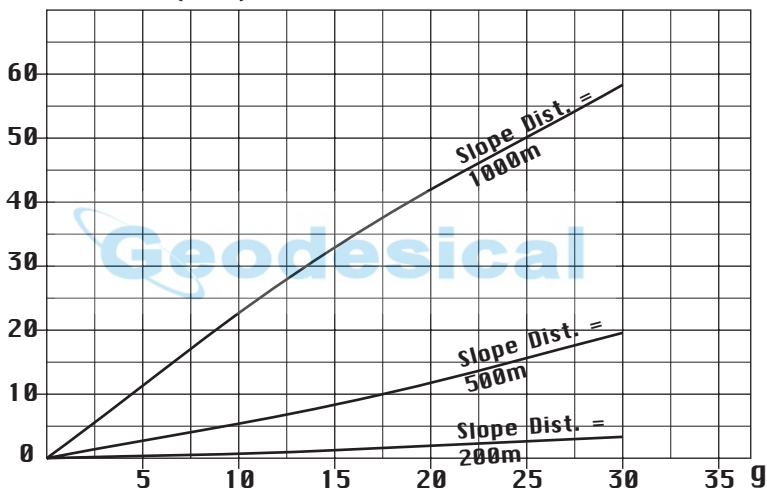

Instrument Height

Instrument height is the vertical distance between the bench mark/height point and the centre of the prism symbols on the side of the instrument – i.e., the line of collimation of the telescope.

Signal Height

Signal height is the vertical distance between the point of the rod and the centre of the target arrow marks on the reflector system. Remember to take into consideration the penetration depth of the ranging rod if working on very soft surfaces and if carrying out accurate survey work!

Atmospheric Correction

As the speed of light varies slightly when passing through different air pressures and temperatures, an atmospheric correction factor must be applied in order to achieve the correct distance. This atmospheric correction factor is calculated according to the following formula:

$$\text{ppm} = 274.41 - 79.39 \times \frac{p}{(273.15 + t)} + 11.27 \times \frac{p_w}{(273.15 + t)}$$

p = pressure in millibars

p_w = partial pressure of watervapour in millibars

t = dry air temperature in degrees centigrade (Celsius)

The partial pressure of watervapour (p_w) is calculated according to the following:

$$p_w = \frac{h}{100} \times 6.1078 \times e^{\left(\frac{17.269 \times t}{237.3 + t}\right)}$$

OR

$$p_w = 6.1078 \times e^{\left(\frac{17.269 \times t'}{237.3 + t'}\right)} - 0.000662 \times p(t - t')$$

p = pressure in millibars

p_w = partial pressure of watervapour in millibars

t = dry air temperature in degrees centigrade (Celsius)

t' = wet temperature in degrees centigrade (Celsius)

h = relative humidity in %

Geodimeter System 600 calculates and corrects for this automatically. Please ensure that the instrument is working with the correct units, MNU 65, Unit.

Examples:

To show the significance of the different units used for calculating the ppm factor let's take a look at the following:

At 20°C dry air temperature 0.1 ppm corresponds to an approximate change of:

- dry temperature: 0.1°C
- air pressure: 0.3 mbar
- relative humidity: 10%
- wet temperature: 1.3°C

At 40°C dry air temperature 0.1 ppm corresponds to an approximate change of:

- dry temperature: 0.1°C
- air pressure: 0.3 mbar
- relative humidity: 4%
- wet temperature: 0.8°C

As shown in the first example above relative humidity has quite a small influence on the ppm factor. It's much more important to be precise when it comes to dry temperature and air pressure. In hot regions relative humidity becomes more important, though.

Care & Maintenance

Overview	2.10.2
Cleaning	2.10.3
Condensation	2.10.3
Packing for Transport	2.10.3
Warranty	2.10.3
Service	2.10.4



Overview

Geodimeter System 600 is designed and tested to withstand field conditions, but like all other precision instruments, it requires care and maintenance.

- ❑ *Avoid rough jolts and careless treatment.*
- ❑ *Keep lenses and reflectors clean. Always use lens paper or other material intended for cleaning optics.*
- ❑ *When the instrument is not being used, keep it protected in an upright position, preferably in its transport case.*
- ❑ *Don't carry the instrument while mounted on the tripod in order to avoid damage to the tribrach screws.*
- ❑ *Servo instruments only: Do not rotate the instrument by the handle. This may have an effect on the HA ref. How much it effects the value depends on the quality of the tribrach and the tripod. Use instead the servo controls to rotate the instrument.*
- ❑ *Don't carry the instrument by the telescope barrel. Use the handle.*
- ❑ *When you need extremely good measurement precision, make sure the instrument has adapted to the surrounding temperature. Great variations of instrument temperature could affect the precision.*

Warning: Geodimeter System 600 is designed to withstand normal electromagnetic disturbance from the environment. However, the instrument contains circuits sensitive to static electricity and the instrument cover must not be removed by unauthorized personnel. If the instrument cover has been opened by an unauthorized person, the function of the instrument is not guaranteed and the instrument warranty becomes invalid.

Cleaning

Caution must be exercised when the instrument is cleaned, especially when sand and dust are to be removed from lenses and reflectors. Never use coarse or dirty cloth or hard paper. Anti-static lens paper, cotton wad or lens brush are recommended. Never use strong detergents such as benzine or thinner on instrument or case.

Condensation

After survey in moist weather the instrument should be taken indoors, the transport case opened and the instrument removed. It should then be left to dry naturally. It is recommended that condensation which forms on lenses should be allowed to evaporate naturally.

Packing for Transport

The instrument should always be transported in its transport case, which should be locked.

For shipment to a service shop, the names of the sender and the receiver should always be specified clearly on the transport case.

When sending this instrument for repair, or for other service work, a note describing fault, symptoms or requested service should always be enclosed in the transport case.

Warranty

Spectra Precision AB guarantees that the Geodimeter instrument has been inspected and tested before delivery. The length of the warranty is stated in the Warranty Conditions.

All enquiries regarding the warranty should be directed to the local Geodimeter representative.

Service

We recommend that you, once a year, leave the instrument to an authorized Geodimeter service workshop for service. This is to guarantee that the specified accuracies are maintained. Note that there are no user servicable parts inside the instrument. Always leave the instrument to your dealer or authorized service workshop if any problem should occur.



Card Memory

Overview _____	2.11.3
Installation _____	2.11.3
How to run the installation program _____	2.11.3
Function _____	2.11.4
How to connect to a Geodimeter System 600 instrument _____	2.11.4
How to insert the memory card _____	2.11.6
Memory Card _____	2.11.8
Handling hints _____	2.11.9

Illustrations

- 
- Fig. 11.1 Geodimeter System 600 Card Memory
- Fig. 11.2 How to attach the card memory on an instrument
- Fig. 11.3 How to connect the card memory using the system cable
- Fig. 11.4 Attach the card memory to a battery with 2 connectors.
- Fig. 11.5 Attach the card memory to a battery with 1 connector with the help of the T-connector.
- Fig. 11.6 How to insert the memory card into the card memory device
- Fig. 11.7 Geotronics memory card



Fig 11.1 The Geodimeter System 600 Card Memory

Overview

The optional Card Memory (571 222 000) opens the possibility of storing measurement data on portable PCMCIA, ATA Sundisk memory cards. These can then be read from an ordinary computer. Thus data can be transferred between the Geodimeter and a PC and vice versa without having to bring the instrument with you. The portable card comes handy in a normal size pocket.

Installation

How to run the installation program

The Card Memory device is delivered with an installation program which you should run to install the device for your instrument if you have program version 632.02.01 or older. For the installation you will need a computer, a Geodimeter System 600 instrument and a system cable for connecting the computer with the instrument. Please follow the instructions that are enclosed with the Card Memory device to complete the installation.

Please see page 1.1.19 for instruction on how to check the program version in your instrument.

How to connect to a Geodimeter System 600 instrument

You can attach the Card Memory unit in two ways:

1. If you have to have Panel Attachment at the front of the instrument, that is the side opposite to the operator, you can attach the Card Memory unit to the instrument in the same way as the ordinary keyboard unit.



Fig 11.2 How to attach the card memory on an instrument.

2. You can also hang the Card Memory while in its case on the tripod and attach it to the foot connector on the instrument with the system cable (571 202 188/216 (1m/2m)).



Fig 11.3 How to connect the card memory using the system cable.

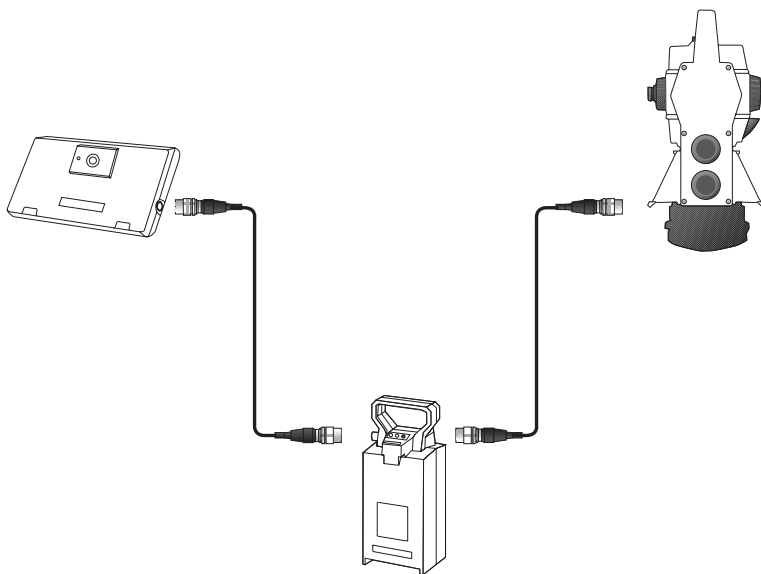

Fig. 11.4 Attach the card memory to a battery with 2 connectors.

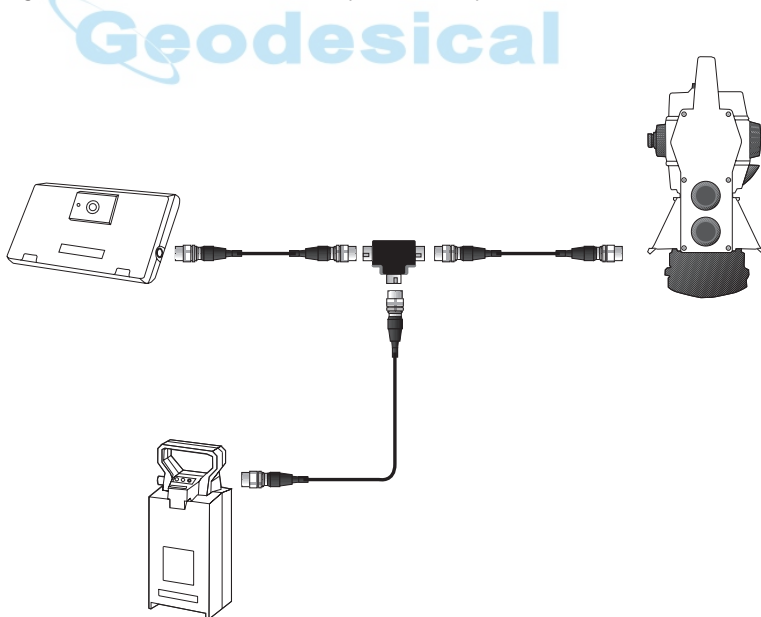

Fig. 11.5 Attach the card memory to a battery with 1 connector with the help of the T-connector.

How to insert the memory card

To insert the memory card into the Card Memory please do the following:

1. Open the Card Memory door.
2. Turn the memory card so that you can read the Geotronics logotype from left to right.
3. Insert the card into the card slot until you hear a click.
4. Shut the Card Memory door until you hear a click.

1.



2.



3.

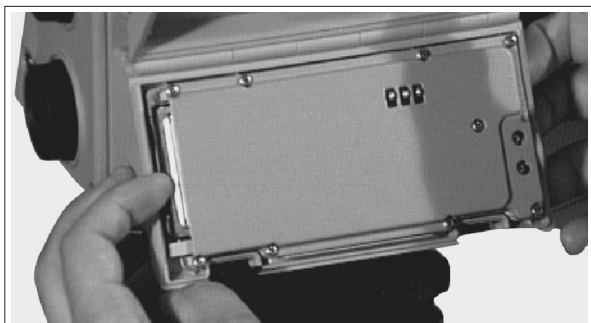

Fig 11.6 How to insert the memory card into the card memory device.

To replace the memory card do the following:

1. Open the Card Memory door.
2. Press the small knob on the card slot until the memory card is ejected.
3. You can now take the card and shut the Card Memory door.



Memory Card

The memory card (571 906 195) for the Card Memory is of a type called PCMCIA. It can be read from any card reader that can handle PCMCIA cards of ATA, Sandisc type.

Fig 11.7 Geotronics Memory Card



Capacity

The card can store up to 6.0MB of measurement data which represents approx. 250 000 survey points.

Memory structure

The memory card can be used to store two types of data: survey measurements (Job files) and known coordinates (Area files). These Job- and Area-files consist of separate expansive submemories which means that they can be updated individually at any time without affecting other Job- and Area-files. The total number of files is limited to the total capacity of the memory. The more raw data stored in Job files, the less known coordinate and elevation data that can be stored in Area files and vice versa.

The file names can be max. 8 characters and with 3 characters for the extension, e.g. TESTFILE.JOB.

When you load files from a computer to a memory card, you must load all the files under the root catalogue if you wish to use the files in your instrument.

Handling hints

- The Card Memory device is always the last device in the serial chain. When having it attach on the panel attachment you cannot communicate via the foot connector.
- If you intend to have the Card Memory device attached to the panel attachment, the device must be attached prior to starting the instrument, otherwise you cannot communicate with it.
- If you have formatted a memory card yourself, you can expect the access time to be a little longer than usual, the first time you try to access the card.
- When using the editor and accessing large files from the memory card, you can expect longer access times than when handling files from the internal memory.
- It is recommended that you keep the Card memory door closed at all times except when inserting the memory card and that you take the device indoors after survey in moist weather. It should then be left to dry naturally.
- If Battery low occurs during a file transfer or a registration, you should check that the action was being correctly performed.
- If you have two keyboard panels attached to the instrument at the same time, you cannot access the Card memory.

Geotronics AB cannot be held responsible for any type of memory loss using the card memory.

 **Geodesical**

Remote Targets (RMT)

Overview	2.12.2
RMT602	2.12.2
RMT602LR	2.12.3
RMT600TS	2.12.3
RMT Super	2.12.4

Illustrations

- Fig. 12.1 RMT602
- Fig. 12.2 RMT602LR
- Fig. 12.3 RMT600TS
- Fig. 12.4 RMT Super

Overview

Geodimeter System 600 Pro (servo) instruments equipped with a Tracker unit can be used to perform surveying tasks using the Autolock™ function. If you upgrade your instrument with a radio you are also able to perform Robotic surveying, i.e one-person surveying. To be able to use the above functions you must also use some type of Remote Target (RMT).

A Spectra Precision Remote Target consists of a prism reflector and one or several active tracker diodes. The great advantage of using active tracker diode(s) is that you eliminate the risk of the instrument locking on to other reflecting objects than the RMT. Today there are four different models of RMT to choose between for Geodimeter System 600 Pro. All RMT models complies with the regulations for a Class 1 LED device. The tracker diode(s) for each model is pointed out in the figures.

RMT602

RMT602 (Part No. 571 202 220) is the standard remote target for Geodimeter System 600 Pro. It can be used for distances up to 350 m and consists of a tracker diode unit with a miniature prism (Part No. 571 126 060) mounted in front (not included). The RMT602 remote target is powered by two standard 1.5V size LR6/AA replacable batteries which fits into the unit. RMT602 can also be powered externally via the Hirose contact.

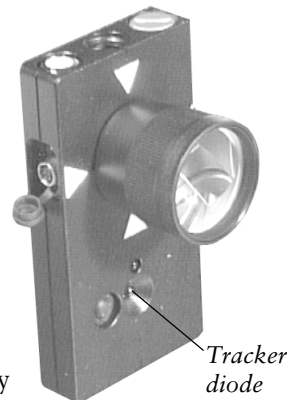

Fig. 12.1 RMT602

RMT602LR

RMT602LR (Part No. 571 202 480) is an RMT602 with an increased range of up to 700 m in Robotic mode and 1000 m in Autolock™. Other specifications are identical to RMT602.

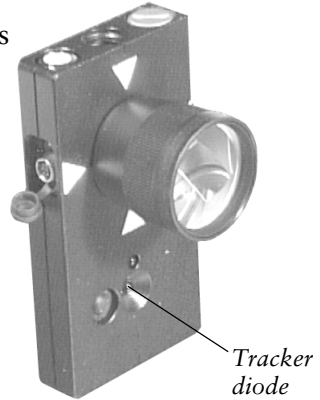

Fig. 12.2 RMT602LR

RMT600TS

RMT600TS (Part No. 571 204 240) is basically a tiltable RMT602LR equipped with a vertical angle sensor. The RMT600TS sends its current vertical angle via the RPU radio to the Geodimeter System 600 Pro instrument. This way the Geodimeter instrument automatically tilts its telescope to the correct vertical angle. This saves a lot of searching time, especially when working in areas or applications where elevation is changed frequently.

RMT600TS is powered externally via its Hirose connector from the RPU radio battery (it is possible to use RMT600TS's internal batteries when working with Autolock™). Do as follows to set up RMT600TS (it is assumed that you have carried out the robotic start procedure as described on page 1.5.12): connect the Georadio from connector A to the control unit

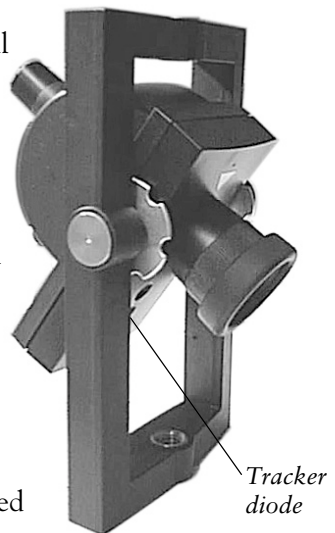

Fig. 12.3 RMT600TS

Note! ➔ Do not use the control unit's internal input/output.

holder 571 204 242. Connect RMT600TS to the other connector of the control unit holder. Switch on the control unit, step through the start-up procedure and wait for the control unit to establish contact with the Geodimeter instrument. The RMT600TS automatically switches on after a short while.

Note! ➔ Remember to define a "search window" before you begin the robotic surveying.

Now tilt the RMT towards the instrument as you view through its coarse sight. Press the **A/M** key on the control unit and the instrument automatically starts searching for your RMT at the correct vertical level. When the instrument has found the RMT it locks on and follows it as you move.

Note! Error 241:

The first time you switch on RMT600TS you may get the error message "Error 241 The RMT needs index" as you press the **A/M** key. This means that the control unit doesn't receive any vertical angle reference from the RMT. To fix this just tilt the RMT past the vertical plumb line and back again – then press **A/M** again. Now the instrument will begin searching for your RMT.

RMT Super

RMT Super (Part No. 571 181 870) consists of a miniature prism (Part No 571 126 060) (not included) mounted on top of a set of active tracker diodes forming a full 360 degree circle. The great advantage with RMT Super is that you don't have to point the RMT towards the instrument to maintain contact. RMT Super is powered externally via a standard Hirose cable.

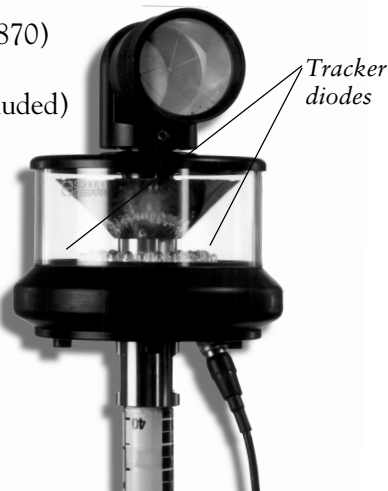

Fig. 12.4 RMT Super

No.	Text	Description
0	Info	Information
1	Data	Data used in INFO/DATA combination
2	Stn	Station No
3	I H	Instrument Height
4	Pcode	Point Code
5	Pno	Point Number
6	SH	Signal Height
7	HA	Horizontal Angle
8	VA	Vertical Angle
9	SD	Slope distance
10	DHT	Vertical Distance (IH and SH not included)
11	HD	Horizontal distance
12	SqrAre	Area of an surface (Result from Program 25)
13	Volume	Volume (Result from Program 25)
14	Grade	Percent of grade ((DHT/HD)*100)
15	Area	Area file
16	dH	Difference between C1 and C2 horizontal angles*
17	HAI1	Horizontal angle which was measured in C2 and stored*
18	VA11	Vertical Angle which was measured in C2 and stored*
19	dV	Difference between C2 and C1 vertical angles*
20	Offset	Offset const. which can be added to or subtracted from the SD
21	HARef	Horizontal Reference Angle
22	Comp	Compensator ON=1, OFF=0
23	Units	Status of unit set, e.g. 3214=(Mills Meter Fahrenheit InchHg)
24	HAI	Horizontal angle which was measured in C1
25	VAI	Vertical angle which was measured in C1
26	SVA	Setting out vertical angle
27	SHA	Setting out horizontal angle
28	SHD	Setting out horizontal distance
29	SHT	Setting out height
30	PPM	Atmospheric Correction, parts per million (PPM)
31	BM ELE	Benchmark elevation
33	PrismC	Prism constant
35	S	Info about Sections (Lenght tables) in P39 RoadLine
37	N	Northing coordinates. Cleared when power OFF
38	E	Easting coordinates. Cleared when power OFF
39	ELE	Elevation coord. Cleared when power OFF (39=49+STN HT)
40	dN	Relative to stored X (N) coord of set out point (P23)
41	dE	Relative to stored Y (E) coord of set out point (P23)
42	dELE	Relative to stored Z (ELE) coord of set out point (P23)
43	UTMSC	Universal Transverse Mercator Scale Factor.
44	Slope	Slope inclination
45	dHA	Correction value of the calculated bearing in Program 20.
46	S_dev	Standard deviation
47	Nr	Rel. North Coord.

* Not in the RPU

No.	Text	Description
48	Er	Rel. East Coord.
49	VD	Vertical distance (IH and SH included) (49 = 10+3-6)
50	JOB No	Job No file for storage of raw and calculated data.
51	Date	Date
52	Time	Time
53	Operat	Operator identification
54	Proj	Project identification
55	Inst.No	Instrument Number
56	Temp	Temperature
57	Blank	Empty row in UDS's where it is convenient to have a blank line.
58	Ea rad	Earth Radius
59	Refrac	Refraction
60	ShotID	Shot Identity
61	Activ	Activity Code
62	Ref Obj	Reference Object
63	Diam	Diameter
64	Radius	Radius
65	h%	Relative humidity in %
66	t'	Wet temperature
67	SON	Northing Coordinate of setting out point
68	SOE	Easting Coordinate of setting out point
69	SHT	Elevation of setting out point
70	Radoffs	Keyed in Radial offset dimension.
71	RT.off	Keyed in Right angle offset dimension.
72	Radoffs	Calculated Radial offset dimension in setting out program.
73	RT.off	Calculated Right angle offset dimension in setting out program.
74	Press	Air Pressure
75	dHT	Difference between ELE and SHT (75=29-39)
76	dHD	Difference between setting out distance and measured distance
77	dHA	Diff. between setting out bearing and the present instr. pointing
78	Com	Communication protocol parameter settings.
79	END	Signifies the end of the User Definable Sequence
80	Sec	Section
81	A-param	A-parameter
82	SecInc	Section Interval
83	Cl ofs.	Center line offset
84	PCoeff	Parabola Coefficient
85	Pht	Point Height difference
86	Layer	Layer number
87	LayerH	Layer Height
88	Profil	Profile number
89	Dist.	Distance from Def. point to Ref. point
90-109	-	Labels which can be defined by the user

Appendix B – Main Menu Configuration

MNU	Instrument		
1 Set	1 PPM	Temp	Press PPM
	2 Preset	1 Excentric point	2 ROE preset
	3 Instr Settings	Display Illumination on/off, Level adjust, Display Contrast adjust, Reticle on/off, Reflected signal volume adjust	
2 Editor	4 Clock	1 Set time	2 Time system
	5 Radio	Channel	Station address Remote address
	6 Long Range**		
3 Coord	1 Imem		
	2 Xmem (Card*)		
	3 Stn Coord	N (X)	E (Y)
4 Data com	2 SetOut Coord	SON	SOE SHT
	3 Fetch Stn data	Fetch Station data	
	1 Select device	1 Imem	2 Serial
5 Test	2 Create table	Table no	
	1 Measure	Measure New	Collimation&Hor Axis Tilt
	2 View current	H Collimation	V Collimation Hor Axis Tilt
6 Config.	3 Tracker Coll.		
	1 Switches	Targ. test on/off, Pcode on/off, Info ack. on/off, HT meas on/off, Power save on/off, Keyclick on/off Prg_num on/off, PPM Adv on/off	
	2 Standard Meas.	1 Standard	2 Fast Standard
	3 Decimals	No of decimals	Label no
	4 Display	1 Select display	2 Create display
	5 Unit	Metre, Feet, Feet/Inches, Grads, Degrees, DecDeg, Mills, Celsius, Fahr, mBar, mmHg, InHg, hPa	
	6 Language	Sw, No, De, Ge, Ja, Uk, Us, It, Fr, Sp	
	7 Coord System	1 North orient.	2 South orient.
8 Prism const	Prism constant		

* The Card memory device is named XMEM when it is attached to the foot contact and CARD when it is attached to the instrument. ** 600M only.

 **Geodesical**