

Motic®

MORE THAN MICROSCOPY



DIGITAL MICROSCOPES

DIGITAL EDUCATION

S E L E C T I O N





DIGITAL

S E L E C T I O N

DIGITALMICROSCOPES

Get ready to explore
the digital world
of microscopy!



In the Motic Digital Education Microscope Selection, we have lined up just one part of our range of digital microscopes suitable for exploring the digital world of microscopy. Whether you are a teacher, a student or just like to work with microscopes, in this catalogue you will definitely find something suitable, for your application and within your budget. Discover the endless possibilities and benefits of using a digital microscope.

Our 2-Year limited warranty (for digital products), is backed by a complete parts inventory that assures availability beyond the two years warranty period.

Motic's aim is to provide a complete package that will allow you to get started immediately. There is no need for you to do the thinking, Motic has already done it for you.

Please take a look at several different digital microscopes and software solutions that we have to offer.

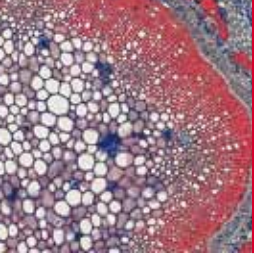

DM52 ●

Simple yet powerful

The **DM52** represents the entry level of the digital biological microscopes. With a resolution of **800x600** pixels, it is the perfect way to start exploring the digital world of microscopy. The 4X, 10X and 40X objectives, together with the **rechargeable LED illumination** with intensity control, make sure that the camera chip is receiving crisp and clear images.

Once connected to the computer, images can be captured, video's recorded and reports can be created with the **user-friendly Motic Play and Educator software**. Additionally the multi language **Motic Images Plus 2.0** analysing software can be downloaded free of charge from our website.

GOINGgreen



- Monocular head with built-in digital camera CMOS 1/4" chip
- 800x600 Pixels USB2.0
- Widefield eyepiece WF10X with built-in pointer
- Triple revolving nosepiece with click stops
- 4X, 10X, 40X(S) Objectives
- Moveable and rotatable stage with stage clips
- Rechargeable LED illumination with intensity control
- Safety auto cut-off charger and batteries included
- Main supply 100V-240V (CE)
- Motic Play for PC & Mac
- Motic Educator for PC & Mac
- Motic Images Plus 2.0 as download
- Calibration slide and dust cover





DM 111

The high school standard

The DM-111 sets the standard for high school students. This model includes the most requested microscope characteristics, such as rugged metal construction, metal focusing gears and student-proof locked on components. The **DM-111** comes standard with 4 objectives; 4X, 10X, 40X and 100X-Oil, providing a total magnification of 1000 times.

With the **integrated camera of 800x600 pixels**, crisp clear images will be displayed via the **Motic Educator** software. When required you can even download the sophisticated **Motic Images Plus 2.0** software free of charge from our website.

GOINGgreen



- Monocular head with built-in digital camera CMOS 1/4" chip
- 800x600 Pixels USB2.0
- Widefield eyepiece WF10X/18mm with built-in pointer
- Quadruple revolving nosepiece with click stops
- DIN Achromatic 4X, 10X, 40X (S), 100X (S, Oil) objectives
- Coarse and fine focusing system with tension adjustment
- Built-in coaxial mechanical stage with slide holder
- Focusable 1.25 N.A. Abbe condenser with iris diaphragm
- Rechargeable LED illumination with intensity control
- Safety auto cut-off charger and batteries included
- Main supply 100V-240V (CE)
- Motic Educator for PC & Mac
- Motic Images Plus 2.0 as download
- Calibration slide, immersion oil and dust cover



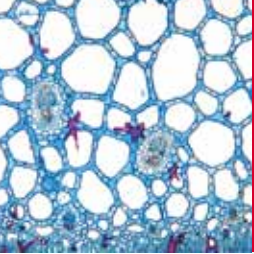

DM1802 ●

Quality & design

The **Motic 18-Series** microscopes are well known for its high optical performance, mechanical quality and its modern design. The **DM-1802** incorporates, besides the characteristics described before, a **high resolution 3.0 Mega Pixel camera**.

Together with the multi-language **Motic Images Plus 2.0** software, high quality pictures, video's and accurate measurements can be made. The **Motic Images Plus 2.0** and the calibration slide for calibrating the software, are supplied together with the microscope.

NEW 3.0MP

- Monocular head, 30° inclined with built-in digital camera CMOS 1/2" chip
- 2048x1536 pixels with USB2.0 output
- Widefield eyepiece WF10X/18mm
- Reversed quadruple revolving nosepiece
- Achromatic objectives EA 4X, 10X, 40X S
- Coarse and fine focusing system with tension adjustment
- Built in low position coaxial mechanical stage
- Focusable 1.25 N.A. Abbe condenser
- Iris diaphragm with filter holder
- Halogen illumination 12V/20W with intensity control
- Switching power supply 100-240V (CE)
- Motic Images Plus 2.0 for PC and MAC
- Calibration slide, blue filter and dust cover



DS2

One of a kind

The **DS-2** is a unique **Digital monoscope**, based on the conventional model MS-2. With its long working distance it is perfect for viewing macro specimens such as plants, insects and minerals.

The **LED illumination**, mounted on a flexible gooseneck arm, guarantees sufficient light from different angles. The **LED illumination** works with rechargeable batteries and can therefore also be used during outdoor biology classes or studies in the backyard.

By connecting the **USB 2.0** cable to your computer and using one of the software provided with the microscope, **Motic Play** or **Motic Educator**, you can **easily capture digital images or create video's**. Besides the Motic Play and Educator, we also offer the possibility to download the sophisticated **Motic Images Plus 2.0** software from our website.

GOINGgreen



- Monocular head with built-in digital camera CMOS 1/4" chip
- 800x600 Pixels USB2.0
- Widefield eyepiece WF10X/18mm
- 2X built-in monoscope objective + additional 2x attachable
- Pole-Type stand with slow falling focusing mount
- Reversible stage plate black/white
- Rechargeable LED illumination mounted on flexible gooseneck
- Safety auto cut-off charger and batteries included
- Main supply 100V-240V (CE)
- Motic Play for PC & Mac
- Motic Educator for PC & Mac
- Motic Images Plus 2.0 as download
- Calibration slide and dust cover





DM 39

Unique Motic design

The **fixed arm stand** with **incident and transmitted illumination** make the **DM-39** an ideal and safe microscope to be used by students.

With a high resolution of **3.0 Mega Pixels**, the integrated digital camera will capture crisp clear pictures. The rotating turret objective with 2X/4X magnification, will allow you to view objects at a total magnification of 20X and 40X.

When the **DM-39C-N9GO** is connected to the computer, countless options are available through the multi language analysing software **Motic Images Plus 2.0**.

NEW 3.0MP

- Binocular head, 45° inclined with built-in digital camera CMOS 1/2" chip
- 2048x1536 pixels with USB2.0 output
- Widefield eyepiece WF10X/20mm
- Objective turret magnification changer (2X, 4X)
- Coarse focusing system with tension adjustment
- Base with fixed arm
- Incident adjustable halogen illumination 12V/10W
- Transmitted tungsten illumination 12V/10W
- Switching power supply 100-240V (CE)
- Motic Images Plus 2.0 for PC and MAC
- Calibration slide
- Black, white and frosted stage plates and dust cover



DMWB1

The sky is the limit

Superior in design and in performance, the **B1-Series** is the most popular microscope amongst teachers. The Achromatic Super Contrast objectives (ASC), provide excellent clarity, great field flatness and superb contrast to the image. And you also should not forget the precise coaxial coarse and fine focusing adjustment, which makes sure your image is in perfect focus. **With the built-in multi output camera the sky really is the limit!**

Either connect the microscope to the **computer** by using the **UBS 2.0** cable (the **Motic Images Plus 2.0** software is included), or connect the microscope to a **TV monitor** via the S-Video cable or connect it straight away to a **projector** with the RCA cable. Not only you can chose between one of the three outputs, **you can also use all three of them simultaneously!**

- Binocular head, 30° inclined with
- Built-in analogue/digital camera CCD 1/3" chip
- 720x576 resolution USB2.0
- Max. 550 TV lines resolution S-Video & RCA
- Widefield eyepieces WF10X/20mm
- Quadruple revolving nosepiece
- Achromatic Super Contrast objectives ASC 4X, 10X, 40X S, 100X S-Oil
- Coaxial coarse and fine focusing system with tension adjustment
- Built in low position coaxial mechanical stage
- Focusable 1.25 N.A. Abbe condenser
- Iris diaphragm with filter holder
- Halogen illumination 12V/20W with intensity control
- Switching power supply 100-240V (CE)
- Motic Images Plus 2.0 for PC and MAC
- USB, S-Video & RCA cables
- Calibration slide
- Blue, yellow, green filters, dust cover and immersion oil



DMW143 ●

The Best of both worlds

Not only is the conventional version of the **SMZ-143-N2GG** the most wanted stereozoom microscope, but also it's digital version **DMW-143-N2GG** is a big hit. The zoom objective ensures high optical quality when observing a sample at 10X magnification, then zooming continuously to close-up details at 40X ... or any point in between.

With the **integrated multi-output camera**, the options are endless. Connect the microscope directly to the computer by using the UBS 2.0 cable and the included multi language **Motic Images Plus 2.0** software. But if you prefer to connect the microscope directly to a TV monitor via the S-Video cable or a direct connection to the projector with the RCA cable? It's also possible! Not only you can chose between one of the three outputs, **you can also use all there of them simultaneously!**

- Greenough zoom optical system
- Binocular head, 45° inclined with built-in analogue/digital camera CCD 1/3" chip
- 720x576 resolution USB2.0
- Max. 550 TV lines resolution S-Video & RCA
- Widefield eyepiece WF10X/20mm
- 4:1 Zoom ratio, WD=80mm
- Magnification range: 1X-4X
- N2GG: Base stand with pole and head holder
- Coarse focusing system with tension adjustment
- Intensity controlled halogen illumination incident 12V/15W and transmitted 12V/10W
- Switching power supply 100-240V (CE)
- Motic Images Plus 2.0 for PC and MAC
- USB, S-Video & RCA cables
- Calibration slide
- Black, white and frosted glass stage plates, blue filter and dust cover





Multi-Output ●

DMW-B1, DMW-143

Both the DMW-B1 and DMW-143 have digital and analogue connections, allowing you to **connect your microscope simultaneously to:**

- Computer
- TV monitor
- Projector / Beamer

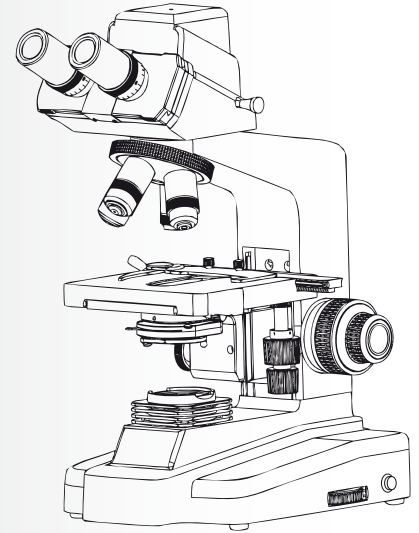

DMWB1

DMW143

simultaneously!

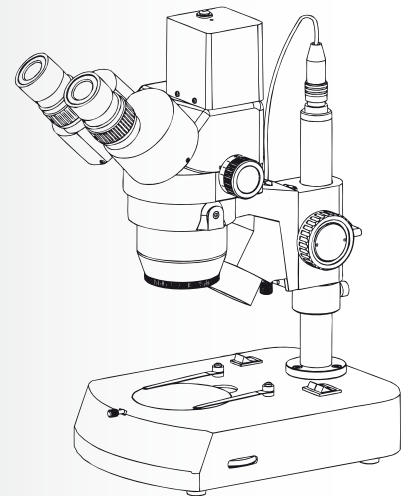
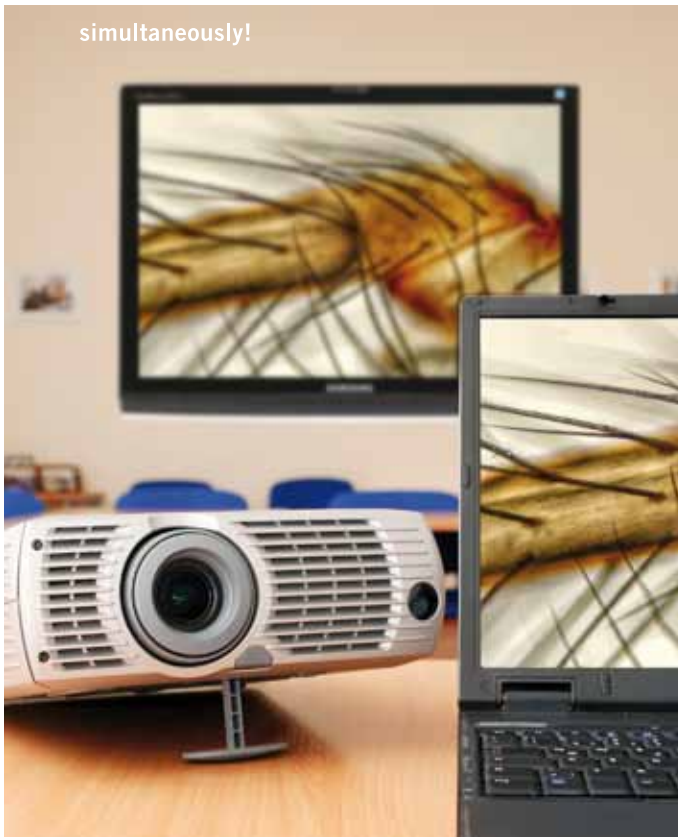

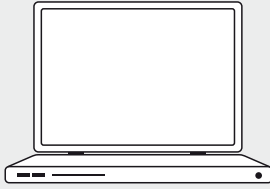

USB



Computer

Through the **USB 2.0** cable you can connect the **digital microscope** directly to your computer. By using the Motic Images Plus 2.0 Software, you can capture images, perform measurements and create video's, with just a few mouse clicks!

The **Motic Images Plus 2.0** is a complete analysing software, which allows you to get the maximum information from the image and use all kinds of image enhancement tools to prepare your picture for reports and presentations.

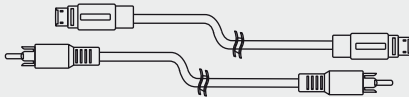

S-Video / RCA



Projector/Beamer

Connect the **digital microscope** directly to your projector/beamer with the **RCA or S-video cable**, in order to share your images with a larger audience. Even when the images are enlarged by the projector, the **digital microscopes** will ensure that crisp clear images are being displayed.

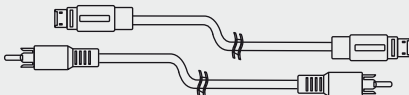
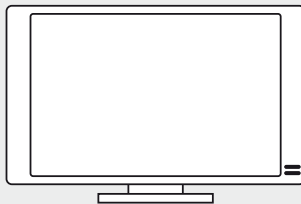

S-Video / RCA



TV Monitor

Use the **S-Video or RCA output** of the **digital microscope** to connect it directly to the TV monitor.

With a resolution of **550 TV lines**, even the finest details will be displayed.



Motic Images Plus 2.0

Sophisticated Image Analysis Software

The multi language image analysis software, **Motic Images Plus 2.0**, is your entry ticket to the digital world of microscopy.

Many years ago this software was introduced as a “basic” software for capturing images and for storing them in a digital format. Nowadays the **Motic Images Plus 2.0** is far from “basic”. With the help of many **Motic Digital Microscope** users around the world it has become **highly sophisticated image analysis software** with the following main functions:

Capture

Auto Capture

Video recording

Measurements

Automated counting

Creating reports

Image comparison

Amalgamation

At the present time we are still in close contact with many users of our software. Approximately each 6 months a new up-date of the **Motic Images Plus 2.0**, can be downloaded on our website. Once you have purchased a digital microscope you can get **unlimited FREE up-dates**.

Besides the software itself, we also put a lot of effort into making the digital microscopes compatible with different types of Operating systems, and of course the new releases of each Operating System. At present our digital microscopes are able to work with Windows (XP, Vista and 7), MAC and LINUX.

In case you would like to use a different Image analysis program with the digital microscope cameras, you can run most cameras by using the TWAIN driver or the DirectShow device.

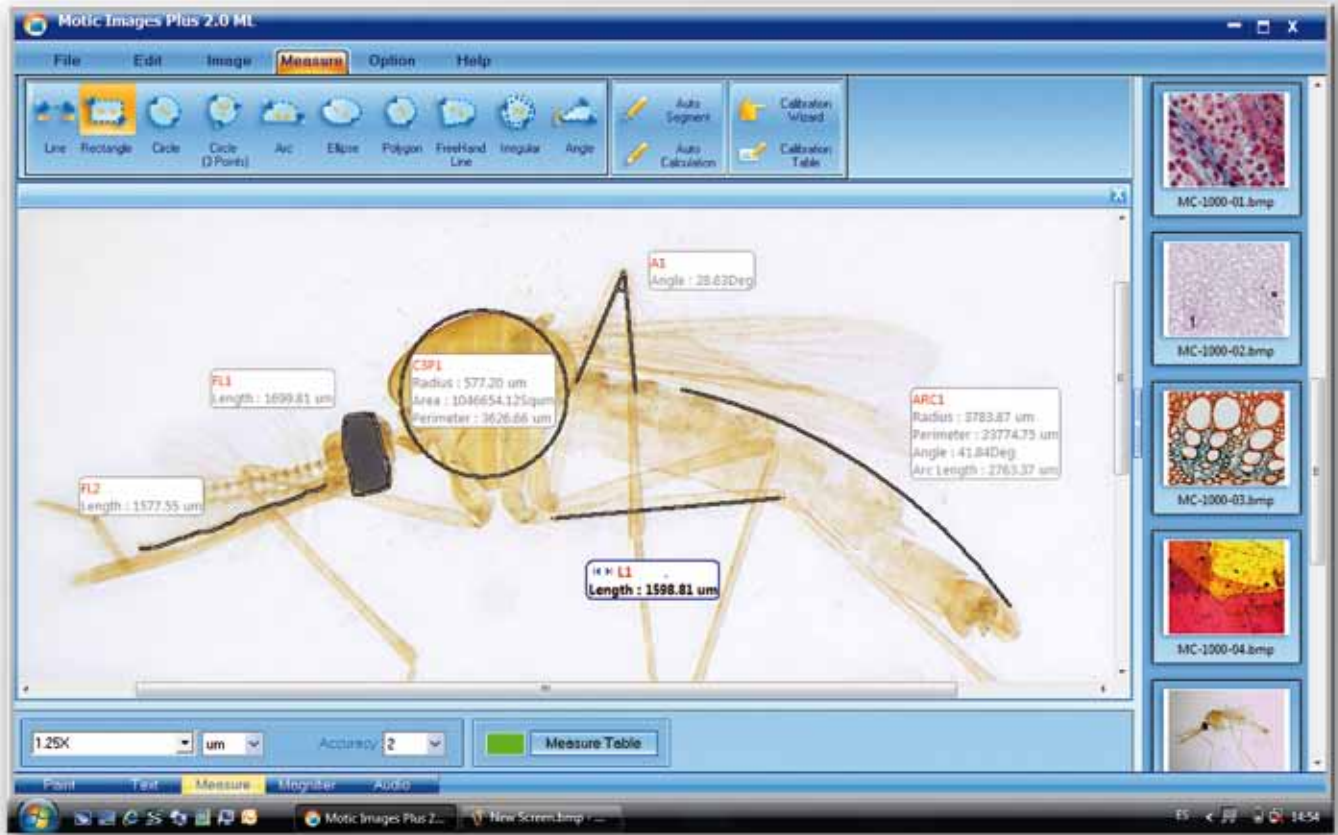

Motic Images Plus 2.0 ML - Measures

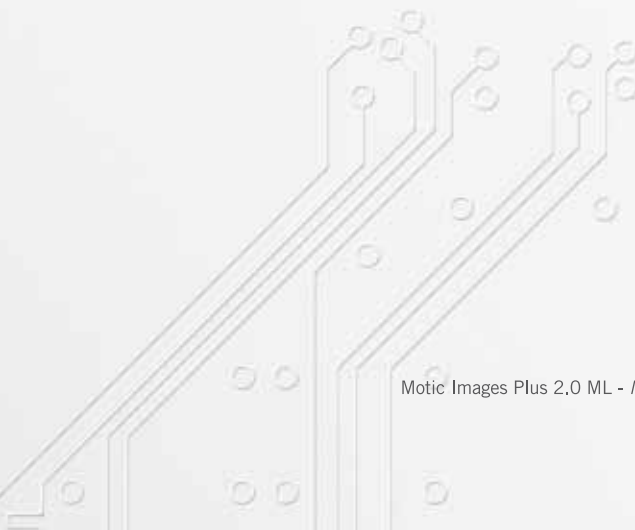

Motic Images Plus 2.0 ML - MI Device



Motic Net

Get your microscopes connected

The network software **MoticNet** is compatible with all Motic digital microscopes. **MoticNet offers the teacher a live overview for each student Digital microscope system.** This overview can be extended up to a maximum of 48 individual digital microscope system, in order to manage even larger classes by a single teacher.

With the **MoticNet** the teacher can have a complete overview over each student's station, and also **control and manipulate the quality of each student's microscope**, by sitting behind the teacher's computer. No need to walk around anymore and having to pass by each individual student to check its progress.

Through a simple mouse click the teacher can broadcast its demonstration. Additionally, **the work at one student's station can also be shared with the entire classroom.** Besides broadcasting a screen with the connected stations, it is also possible to send messages from the teacher's computer to the student in question and vice versa.

MoticNet can even be useful outside of teaching digital microscopy. Having each computer station connected and linked to the central control station of the teacher, MoticNet also allows third party programs, such as Mathematics and Language software, to be launched and used. Allowing full remote keyboard and mouse control, any Windows based program can be launched, controlled and manipulated by the teacher.

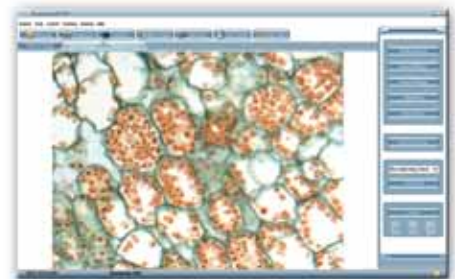

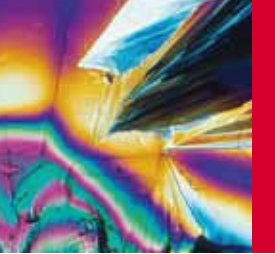

Motic Trace •

Match or no match?

Motic Trace is the software that everyone has been waiting for. There is no need to buy an expensive **comparison microscope** anymore!

Simply connect two or more Moticams or Motic digital microscopes to your computer and get an immediate live comparison through the Motic Trace software.

Not only will you be able to **compare images side by side**, but you will also be able to **overlay, resize and rotate** them independently. Match two fingerprints, authenticate handwriting or determine whether two pieces of fabric belong to the same manufacturer, with the ease of just a few mouse clicks.

Motic Trace works together with Motic Images Plus 2.0 and therefore providing a comprehensive platform for further evaluation of the compared images. **Create your reports with accurate measurements and editing tools.**

All you need is two **Moticam** or two **Motic digital microscopes**, and you can teach forensics.

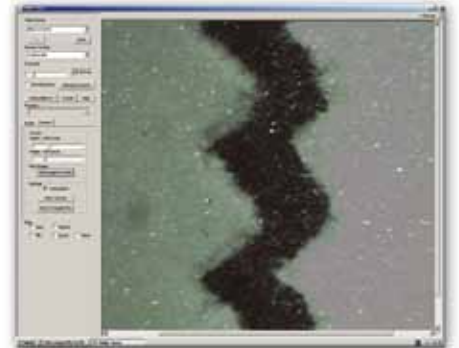
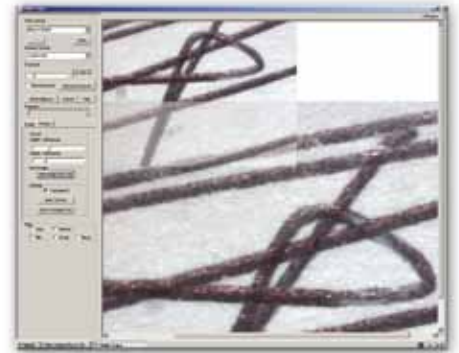



Disclaimer: Given the fact that the developments and improvements in the digital industry are being made on a daily base, you will have to excuse us in the event of small changes either in the specifications of the cameras or the software. All changes are made with the goal to improve our package.

DIGITAL

S E L E C T I O N

DIGITALMICROSCOPES

Motic, more than microscopy



We hope that we have given you a good impression of available Motic digital microscopes and the software possibilities. Of course this is just a small selection from our program. If you are interested in a higher resolution digital microscope and more advanced software, kindly consult your local Motic distributor.

As mentioned several times in the catalogue, we would like to keep in touch with you, whether you are going to purchase or have already purchased your digital microscope. We are very much interested in your opinion, your comments and your suggestions on how we can improve our products. Together we can make it happen!

Your Motic Team

EN | ES | FR | DE | IT | PT | RU

Motic Incorporation Limited Copyright © 2002-2011. All Rights Reserved. December 2011
Motic is a certified ISO9001, ISO14001 and ISO13485 company.

Motic[®]



Canada | China | Germany | Spain | USA

www.motic.com