

SOKKIA**SET2B****SET3B****SET4B****SERIES B TOTAL STATIONS****SET2BII • SET3BII • SET4BII****with BDC25 type battery**

Introducing a total station with more than meets the eye. The New **SERIES B** Total Stations maintain the outstanding construction and operational simplicity characteristic of Sokkia surveying instruments, while incorporating major new features which add up to dramatically increased productivity. **SERIES B** now provides software for Offset and Resection measurements and boasts an internal memory for prestorage up to 100 sets of coordinate data for as long as a week. The powerful on-board battery now supports up to 2,600 measurements on a single charge, and the contrast of the LCD can be adjusted in six steps to clearly display readings under any lighting condition. The new **SERIES B** carries on the Sokkia tradition of providing the best combination of features at the best price to take on every surveying need. Simplicity outside, sophistication inside, quality throughout ...that's Sokkia.

RELIABLE HARDWARE

From the detachable handle down to the detachable tribrach, the new SERIES B Total Station maintains the same ruggedness and dependability surveyors have come to expect from the SERIES B instruments along with some added extras.

SET2B

Accuracy to 2" (0.6 mgon) and distance measurement up to 3,500 m (11,400 ft.) using 3 prisms.

SET3B

Accuracy to 3" (1 mgon) and distance measurement up to 3,300 m (10,800 ft.) using 3 prisms.

SET4B

Accuracy to 5" (1.5 mgon) and distance measurement up to 2,100 m (6,900 ft.) using 3 prisms.

1 Telescope

Coaxial telescope (30x) and distance meter optics provide a single line of sight for optimum observation and measurement. EDM/telescope module rotates completely for readings in both positions.

2 Optical plummet

Centering over the surveying point is made easy with the optical plummet (3x).

3 Battery

Powerful yet portable, the two compact rechargeable batteries provided with the instrument each support up to 2,600 measurements in the field. An auto power off and remaining power indicator function let you know when it is time to pull the second battery out of your shirt pocket.

4 RS-232C

Connection with a personal computer or an SDR Electronic Field Book is facilitated by an RS-232C interface port, which is located in the base so that the instrument can be rotated without cable interference. The instrument also features an extensive two-way communication function for complete control over instrument operations, permitting the development of customized applications.

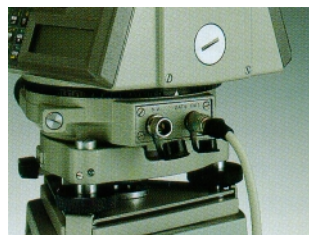

5 Detachable Tribrach

The rugged detachable tribrach reduces set-up time during traverse work by enabling the SERIES B to be easily removed and mounted on another tripod.

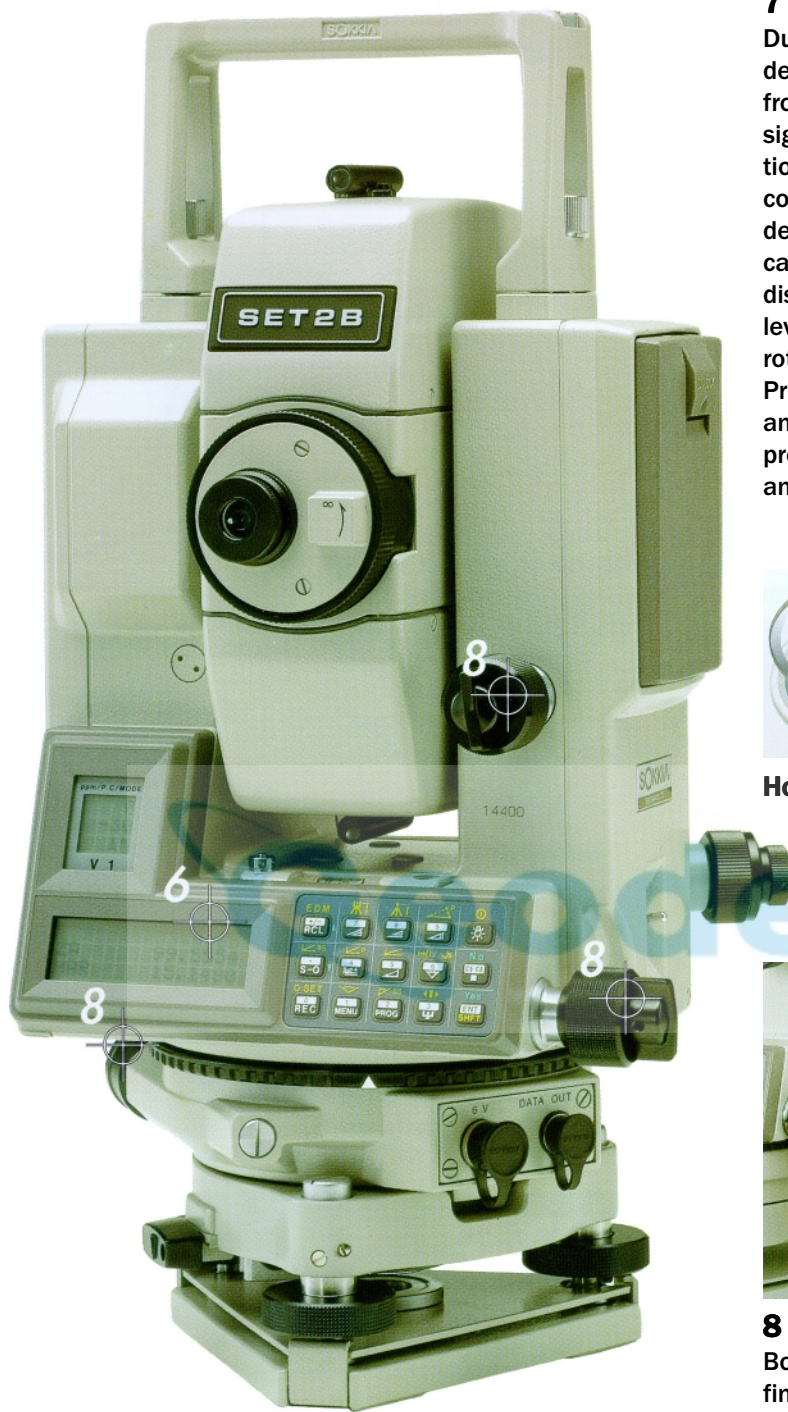

7 Angle measurement

Dual-axis compensator detects deviation of the standing axis from perpendicular in both sighting and trunnion directions and automatically corrects angle readings. The detected X and Y inclinations can be simultaneously displayed for extremely precise levelling without having to rotate the instrument. Precision engineered vertical and horizontal circles and axes provide exceptionally accurate angle readings.

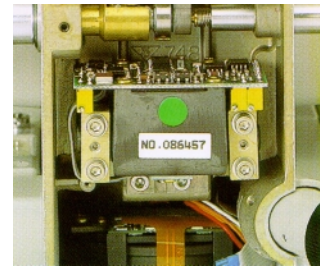

Dual axis compensator



Vertical axis



Horizontal circle



8 Smooth stable sighting

Both vertical and horizontal motion assemblies have coaxial fine motion knobs and wing clamps for optimum motion control. Horizontal and vertical fine motion screws feature two-speed adjustment for precise sighting (SET2B, 3B only). Slide cover on lower horizontal wing clamp prevents accidental movement of horizontal circle.

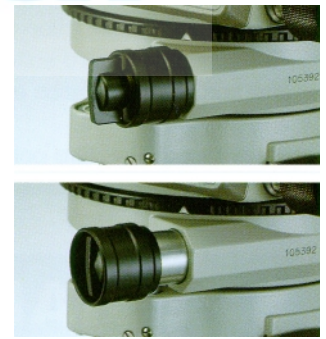

6 Control panel

A complete user-friendly control panel, including keyboard and dual LCDs on each instrument face. LCD features six-step contrast adjustment and nonreflective glass. Simplified keyboard for easy operation.

9 Distance measurement

Precise distance measurement is accomplished through the built-in EDM which now supports both coarse and fine measurement to 1 mm (0.01 ft.). The modulated triple frequency infrared beam provides faster measurement. After the first measurement, fine measurement values are updated every 3.2 seconds and coarse measurement every 0.7 seconds. Tracking measurement is updated every 0.3 seconds.

ERROR FREE MEASUREMENTS

A complete array of onboard software and automatic correction functions make SERIES B the ideal solution for your surveying needs.

Angle measurement

Automatic circle indexing

- Simply rotate the alidade to index the horizontal circle and fully transit the telescope module to index the vertical circle, and then implement desired measurement function.

Measuring mode

- Horizontal:** Select Clockwise, Counterclockwise. Circle can be set to zero or required value by keyboard input.
- Vertical:** Select Zenith angle, Vertical angle, or Height angle.
- Tilt:** Tilt angle can be displayed to allow precise levelling of the instrument without rotation.

Automatic correction

Dual-axis compensator:

A dual-axis liquid compensator with a range of +3' detects deviation of the standing axis from perpendicular in both sighting and trunnion directions and automatically applies the

necessary correction to angle readings (Figure 1).

- Collimation:** Onboard software automatically calculates and corrects collimation error between the reticle center and the line of sight.
- O point error:** The zero point error in the vertical circle and the tilt sensor can be eliminated for angle measurement of the highest accuracy.

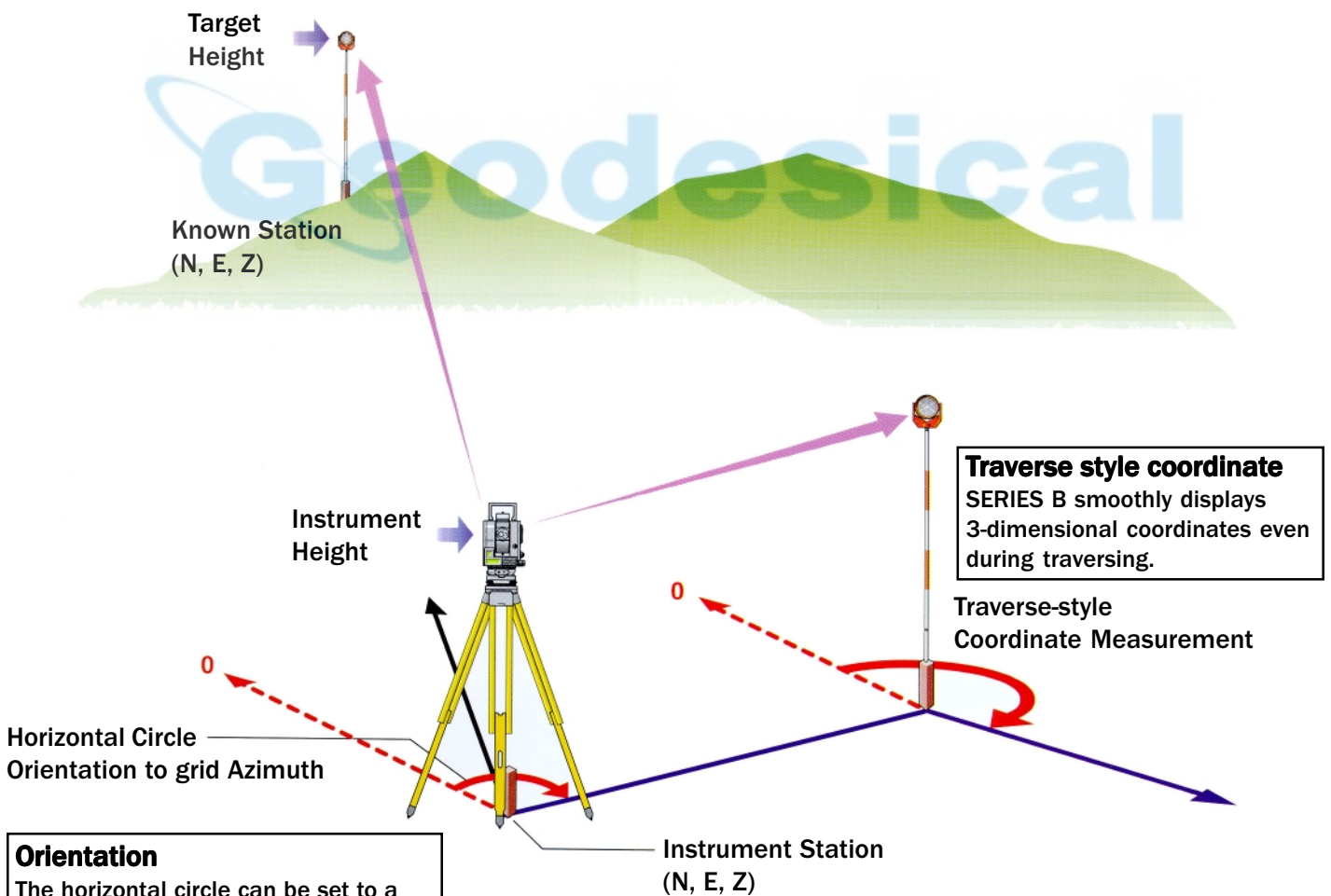
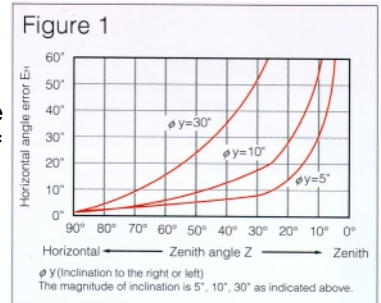

Orientation

The horizontal circle can be set to a known azimuth on the backlight by keyboard entry, or the azimuth can be automatically calculated based on the coordinates of the instrument station and the backsight point.

Distance measurement

Measuring mode

- **Fine, coarse, tracking:** Three modes of measurement to suit all your surveying needs.
- **Slope reduction:** Horizontal distance and height difference are automatically calculated based on measured slope distance.
- **3-D coordinates:** SERIES B quickly measures and displays the 3-dimensional coordinates (NEZ) of the target points in the field. Coordinates can be displayed to 10 digits (9,999,999.999 m or 9,999,999.99 ft.) in either NEZ or ENZ format.

Automatic correction

- **Atmospheric correction:** Correction for temperature, pressure, and relative humidity conditions.
- **Earth curvature and refraction correction:** Automatically applied or ignored depending on instrument parameter setting.
- **Prism constant:** Adjustment within +99 to -99 in 1 mm steps to accommodate use of a variety of prism types.
- **Beam intensity:** Intensity of the EDM beam is automatically adjusted to ensure consistently accurate measurement.

SPECIAL MEASUREMENTS

Missing line

Measurement of horizontal, slope, and height distance between starting prism and a series of subsequently selected prisms from a single instrument station.

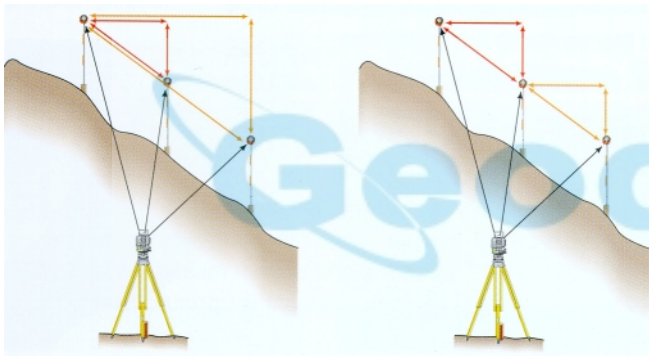

REM

SERIES B can easily determine the height of a point where a prism cannot be directly placed by simply sighting a prism directly over or under the point and then sighting the point itself.

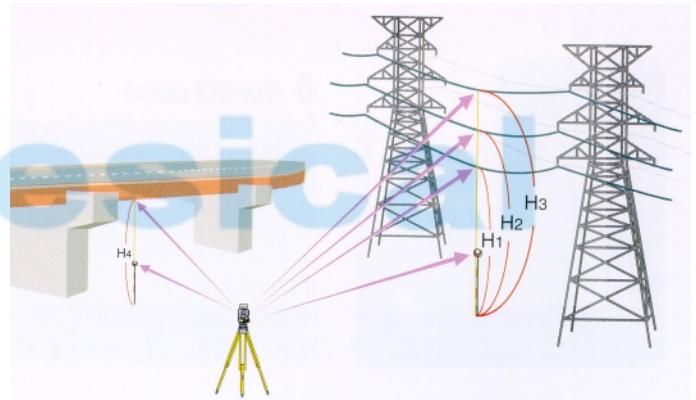

Offset 1

Determine distance, angle, and coordinates of a point where a prism cannot be set by sighting a second prism (offset point) at a location the same distance away from the instrument station. Inputting the distance between the offset point and the target point facilitates calculation of the distance, angle and coordinates of the target point.

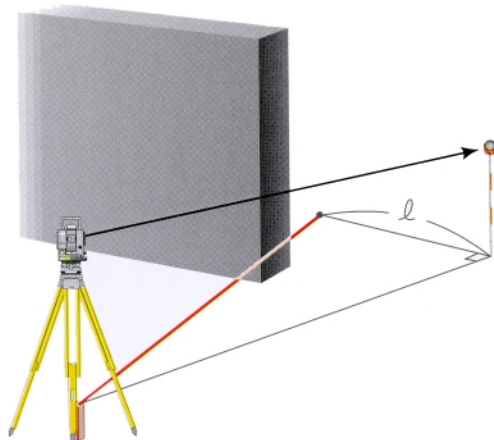

Offset 2

Distance, angle, and coordinates of the target point are calculated based on the angle measurement between the target point and the measured offset point.

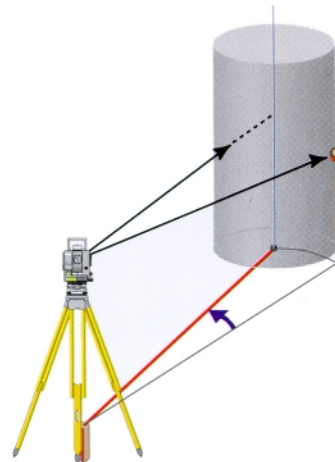

SURVEYING FOR ROAD CONSTRUCTION

At the office



Designing

Designing road construction and ensuring accurate implementation has never been more efficient. Coordinate values determined by road designing software at the office can be directly input and stored in the internal memory of the new SERIES B Total Station. Up to 100 sets of coordinate data can be prestored in the instrument at the office for accurate transfer of stake-out data for use in the field.

Two options for inputting coordinates:

Predetermined coordinates can be entered by keyboard input or directly from a data storage source (e.g., personal computer) via the two-way communication function. More than 40 commands (in ASCII code) are available through the extensive two-way communication function, allowing a complete exchange of data between the instrument and an external device. The instrument can be operated by an external computer, including the selection and implementation of measurement modes and functions.

Command (Coordinate data input to memory)

Dg	1001.426	,	2005.970	,	50.966	,	301	
----	----------	---	----------	---	--------	---	-----	--

N-coordinate E-coordinate Z-coordinate Point number
(1 ~ 9999999)

In the field

Resection

By observing from two to five known points, the new SERIES B can calculate instrument station coordinates based on either angle and distance (at least two known points) or angle alone (at least three known points). Set up the instrument to facilitate observation of the known points and recall the coordinate data for those points from the built-in memory. Sight the required minimum number of known points and the instrument coordinates will be automatically calculated.

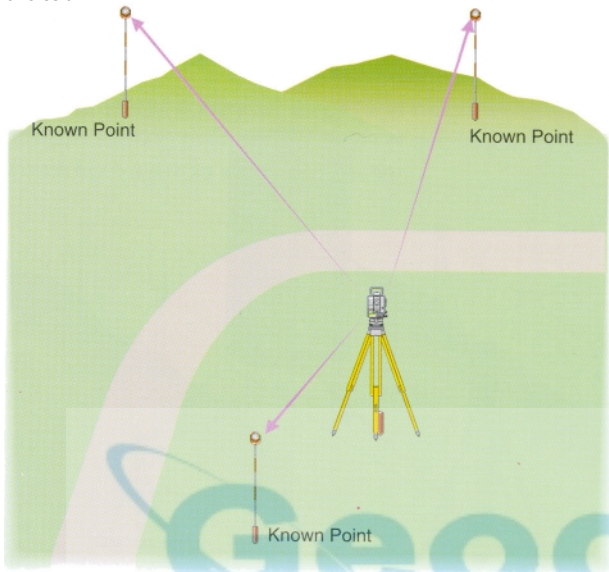

Setting out

Once the instrument coordinates are known, set the horizontal circle reading to grid azimuth using a backlight point. Next, recall the coordinates to be set out from the internal memory. SERIES B automatically calculates the setting-out azimuth and horizontal distance values from the instrument station point to the point to be set out.

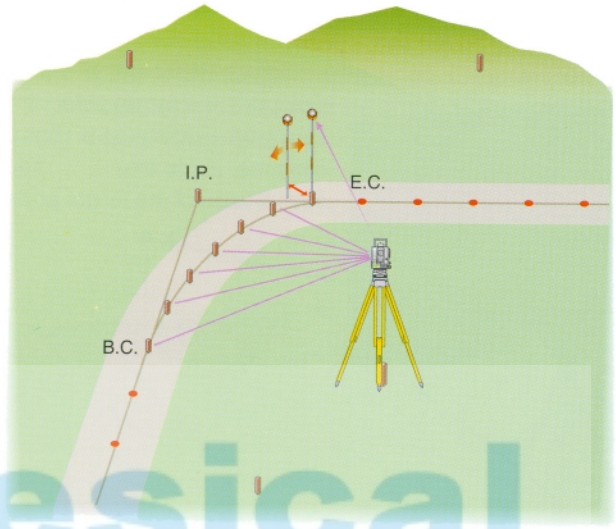

Move the instrument

When it is time to move the instrument to complete the task, relocate to an area from which a sufficient number of known stations can be sighted to determine the new instrument station coordinates. The new instrument station coordinates can also be determined by traverse-style coordinate measurement.

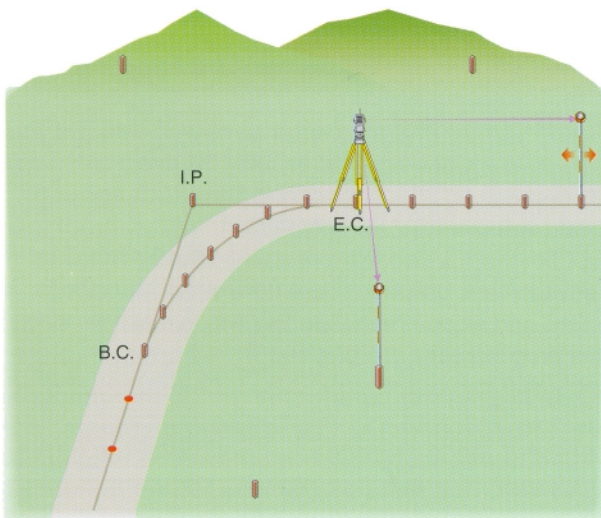

COMMUNICATIONS

Diagram of communication system

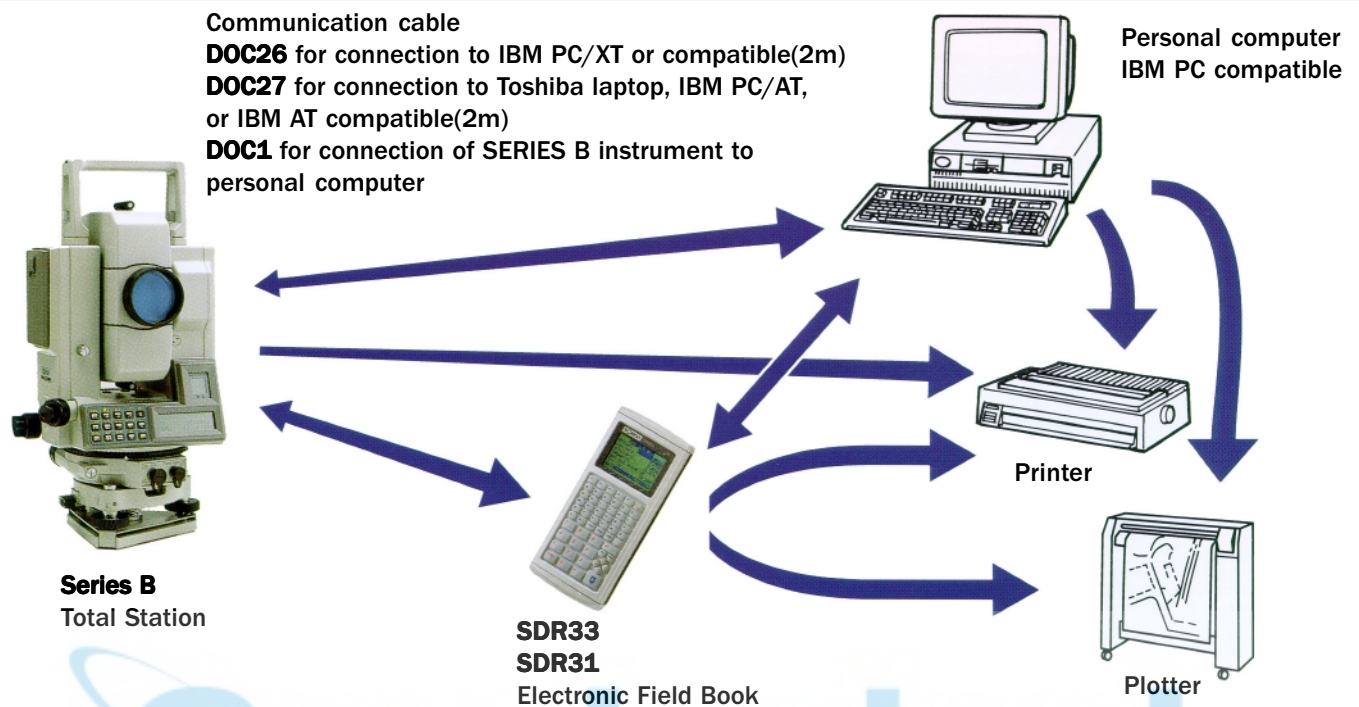

Electronic Field Book SDR33 • SDR31



Two models—Standard and Expert—are available to fit the specific surveying task. The software functions of both models—supporting such specialized measurement tasks as Setting out, Resection, and Road cross-section—are readily implemented by separate alphanumeric keys and grouped cursor keys for faster inputting. The Expert model is specifically designed for road construction surveying. The Electronic Field Book units combine ergonomic considerations with resistance to weather and impact to provide an optimum integration of rugged durability with ease of use.

Software



The Sokkia Comms Plus program is an easy-to-use, fast and effective software package that enables the direct exchange of data between an SDR33 Electronic Field Book and a personal computer (IBM PC compatible). Sokkia Comms Plus also features a user-friendly Windows™ style environment, optional mouse control, full file editing capability, and an on-board Help function to make working with the program easy and efficient.

SPECIFICATIONS

SET2B, SET3B, and SET4B Specifications

	SET2B	SET3B	SET4B
Telescope	Fully transiting, Coaxial EDM transmitting and receiving optics integrated in the theodolite telescope.		
Length	177 mm (7 in)		
Objective aperture	Sighting: 45 mm (1.8 in), EDM: 50 mm (2 in)		45 mm (1.8 in)
Magnification, Image	30x, Erect		
Resolving power	3"		
Field of view [at 1,000 m]	1° 30' [26 m]		
Minimum focus	1.3 m (4.3 ft.)		
Reticle illumination	Built-in (Bright/ Dim, selectable)		
Angle measurement	Photoelectric incremental rotary encoder scanning. Both circles adopt diametrical detection and are provided with absolute 0 index points		
Display resolution			
Angle unit	H&V 360° sexagesimal, or 400 gon, selectable		
Accuracy (Standard deviation of mean of a measurement taken in position I and 11, according to DIN 18723)			
	H&V 2" (0.6 mgon)	3" (1 mgon)	5" (1.5 mgon)
Measuring time	H&V Less than 0.5 seconds, continuous		
Automatic dual-axis level compensator	ON/OFF selectable, Type: Dual-axis liquid tilt sensor. Range: ±3" (±55 mgon), Display resolution: According to selection of display resolution, Out-of-range warning: Message displayed		
Display mode	H Clockwise, Counterclockwise, Clockwise-accumulation*, selectable; 0 set, Hold* available V Zenith angle (Zenith 0), Vertical angle (Horizontal 0), Height angle (Horizontal 0±), selectable		
Distance measurement	Electro-optical with modulated infrared light		
Range(Slope distance)	A. Average conditions: slight haze, visibility about 20 km (12 miles), sunny periods, weak scintillation G Good conditions: no haze, visibility about 40 km (25 miles), overcast, no scintillation		
with CP01 compact prism	A. 1.3m(4.3 ft.)~800m(2,600 ft.)	1.3m(4.3 ft.)~700m(2,300 ft.)	1.3m(4.3 ft.)~600m(1,900 ft.)
with one AP01 prism	A. 1.3m(4.3 ft.)~2,400m(7,800 ft.) G. 1.3m(4.3 ft.)~2,700m(8,800 ft.)	1.3m(4.3 ft.)~2,200m(7,200 ft.) 1.3m(4.3 ft.)~2,500m(8,200 ft.)	1.3m(4.3 ft.)~1,200m(3,900 ft.) 1.3m(4.3 ft.)~1,500m(4,900 ft.)
with three AP01 prisms	A. 1.3m(4.3 ft.)~3,100m(10,100 ft.) G. 1.3m(4.3 ft.)~3,500m(11,400 ft.)	1.3m(4.3 ft.)~2,900m(9,500 ft.) 1.3m(4.3 ft.)~3,300m(10,800 ft.)	1.3m(4.3 ft.)~1,700m(5,500 ft.) 1.3m(4.3 ft.)~2,100m(6,900 ft.)
with nine AP01 prisms	A. 1.3m(4.3 ft.)~3,700m(12,100 ft.) G. 1.3m(4.3 ft.)~4,200m(13,700 ft.)	1.3m(4.3 ft.)~3,500m(11,400 ft.) 1.3m(4.3 ft.)~4,000m(13,000 ft.)	1.3m(4.3 ft.)~2,200m(7,200 ft.) 1.3m(4.3 ft.)~2,800m(9,200 ft.)
	Maximum range is achieved by using Sokkia CP01 Compact prism and AP prism system.		
Display resolution	Fine and coarse measurements: 0.001m (0.01 ft.) Tracking measurement: 0.01 m (0.1 ft.)		
Distance unit	Meters or Feet, selectable by parameter setting or via keyboard*		
Accuracy	Fine measurement ±(3+2ppmXD)mm Coarse measurement ±(5+5ppmXD)mm	±(3+3ppmXD)mm (D=measuring distance in mm)	±(5+3ppmXD)mm
Measuring time	Fine measurement every 3.2 sec. (initial meas. 4.7 sec.) Coarse measurement every 0.7 sec. (initial meas. 1.7 sec.) Tracking measurement every 0.3 sec. (initial meas. 1.8 sec.)		
Modulation frequencies	3 frequencies		
Unambiguous measuring range	9,999.999m (32,808.33 ft.)		
Atmospheric correction	Input range	The factor (ppm) automatically calculated and applied by keying in temperature (°C or °F) and pressure (mb, mmHg or inchHg) within the range of -30°C to +60°C and 500 mb to 1,400 mb	
	PPM range	-499 to +499 ppm (1 ppm steps)	
Prism constant correction	-99 to +99 mm (1 mm steps)		
Refraction & Earth-curvature correction	ON/OFF selectable, The value of atmospheric refraction constant "K" is selectable either 0.142 or 0.20 when the correction is applied		
Audio target acquisition	ON/OFF selectable		
General			
Display unit	Four alphanumeric (dot matrix) LCDs with built-in illumination Sub-display (4 characters x 3 lines) and Main display (16 characters x 3 lines) on each face Range of coordinate to be displayed: -9,999,999.999m to 9,999,999.999m (-9,999,999.99 ft. to 9,999,999.99 ft.) Measuring mode (ppm, prism constant, and measuring mode) is always shown on each sub-display.		
Keyboard	15 latex keys on each face, control all functions and settings Range of value to be entered: -9,999,999.999m to 9,999,999.999m (-9,999,999.99 ft. to 9,999,999.99 ft.) Range of point to be entered: 1 to 99999999 Code: up to 13 characters long can be entered for each code: available characters are 0 to 9, A to Z, ([space]), ([period]), ([hyphen]), (& [ampersand]) Note: up to 20 characters long		
Sensitivity of levels	Plate level 20"/2mm Circular level 10"/2 mm (in tribrach)	30"/2mm	
Optical plummet	In alidade, Image: Erect, Magnification: 3x, Minimum focus: 0.1m (0.33 ft.)		
Standing axis	Double		
Self-diagnostic function	Messages/codes displayed		
Battery check display	Codes/message displayed		
Automatic power cut-off	30 minutes after operation, ON/OFF selectable		
Data storage	Onboard 100 coordinate data can be stored in an internal memory. External Connect an external device (e.g., SDR Electronic Field Rook) via interface port		
Interface	Asynchronous serial, RS-232C compatible (Baud rate: 2,400 bps/1,200 bps, Checksum: Yes/No, Parity: No/Even, selectable)		
Operating temperature	-20°C to +50°C (-4°F to +122°F)		
Tilting / Trunnion axis height	236 mm (9.3 in) from tribrach bottom, 193 mm (7.6 in) from tribrach dish		
Size with handle and BDC25	W168 x D177 x H371 [w/o handle, H: 330]mm (W6.6 x D7.0 x H14.6 [w/o handle, H: 13.0] in)		W168 x D170 x H371 [w/o handle, H: 330]mm (W6.6 x D6.7 x H14.6 [w/o handle, H: 13.0] in)
Weight with handle and BDC25	7.4 kg (16.3 lbs); BDC25 battery: 235g (8.3 oz); Handle: 200g (7 oz);		7.3 kg (16.1 lbs)
Operating voltage	6V DC		
Power supplies			
BDC25 Rechargeable battery	Ni-Cd, 2 supplied		
Continuous use at 25°C (77°F)	Angle mode: 9.5 hours, Angle + Distance mode: about 2,500 to 2,600 measurements (Coarse and single meas.)		
Charging time	80 min. with CDC27, CDC31 charger, 12 hours with optional CDC11 series charger, 80 min. with optional CDC29 charger		
BDC12 Large external rechargeable battery	Ni-Cd, plugs into base by EDCC3 cable, optional		
Continuous use at 25°C (77°F)	Angle mode: 47 hours, Angle + Distance mode: about 12,500 to 13,000 measurements (Coarse and single meas.)		
Charging time	15 hours with optional CDC14 series charger		

Specifications not listed under specific instruments are identical to those appearing to the left.

*Available only with version A type instrument.
Design and specifications are subject to change without notice.

ACCESSORIES

SET2B, SET3B, and SET4B Total Stations Standard equipment:

Main unit with WA-type tribrach, two BDC25 Rechargeable batteries, EDC19 Battery charging adapter, CDC27 or CDC31 Quick charger, CP7 Tubular compass, Sunshade, Lens cap, Plumb bob, Vinyl cover, Tool kit, Operator's manual, Two-way communication manual, Field guide and Carrying case.

Reflecting Prisms

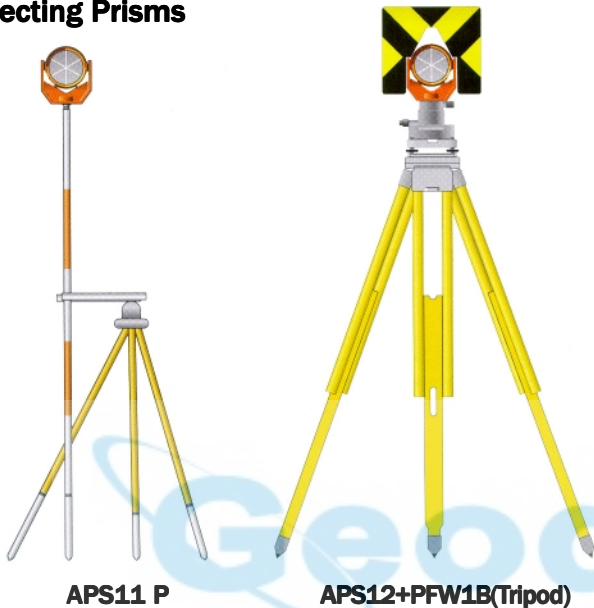

- APS12** Single tilting prism complete with coaxial target
- APS11** Single tilting prism complete with sighting pole
- APS33** Triple stationary prism complete with coaxial target
- APS31** Triple stationary prism complete with sighting pole
- APS34** Triple tilting prism complete with coaxial target
- APS32** Triple tilting prism complete with sighting pole
- APS91** Nine prism complete
- APS11P** Range pole prism complete (single, tilting)
- APS12P** Range pole prism complete (single, double yoke tilting)
- CPS11P** Compact prism complete (single, tilting)

Tribrach

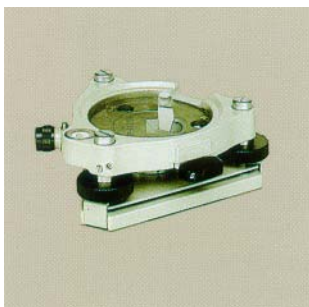

WOA
Detachable tribrach fitted with optical plummet.

Diagonal eyepiece



DE18
Diagonal eyepiece allows sighting at steep angles up to zenith.

A complete range of components and accessories:

A complete range of components, including reflecting prisms, traversing equipment, tripods, optional power supplies, and electronic Field books, is available to suit any application or field condition. These systems are compatible with other Sokkia instruments. For more detailed information, please ask your distributor for individual product brochures or for our complete general catalogue.



Soft case SC67
Soft case can hold APS12 or APS 11 sets.

Tripod



PFW1B
Hardwood telescopic tripod, head screw: 5/8 in. dia.

PFG3
Hardwood/fiberglass telescopic tripod, head screw: 5/8 in. dia.

Backpack



SC84
Designed for both comfort and rugged performance, the SC84 features an aluminum frame, weather-proof hyperon exterior, and polyethylene foam padding to protect the instrument.

Objective solar filters



OF2A • OF1A
Objective solar filters, flip-type, for solar observations.

Objective solar filters



OF2 • OF1
Objective solar filters for solar observations.

POWER SUPPLIES

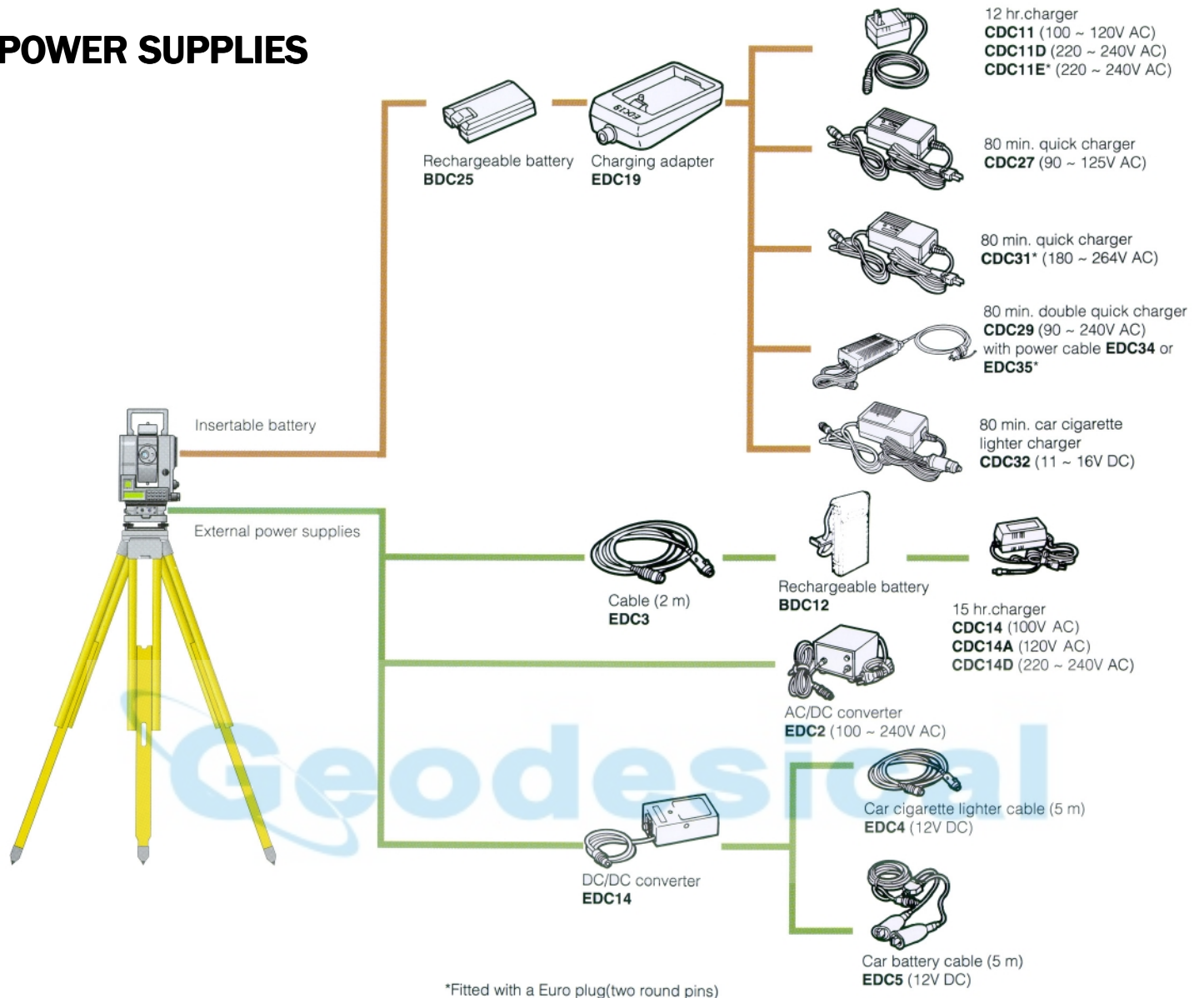

CDC32



CDC29



EDC2



BDC12



EDC14+EDC5

Introducing Sokkia

SOKKIA CO., LTD. is the world's leading manufacturer and supplier of surveying instruments, including Total Stations and theodolites, levels, electronic field books, and surveying software. Sokkia's innovative products and manufacturing processes benefit from a strong commitment to research and development. The focus of our efforts is to incorporate advanced technologies which boost productivity and ensure dependable performance under the most severe field conditions. Innovative designs and careful attention to detail from a user's perspective have been the hallmarks of Sokkia instruments for over 70 years. Furthermore, every Sokkia instrument is subject to strict quality control measures involving rigorous inspection at each stage of production. After final assembly, the instruments are subjected to a further battery of tests including simulation of extreme weather conditions. We feel, however, that Sokkia's most important component is its team of skilled professionals who support Sokkia products around the world to ensure that users gain the full benefits of the finest surveying equipment and systems available. Under the company slogan "Our best for the world," our network of offices in North America, Europe, Oceania, and Asia provides marketing and customer support around the world. We are proud to continue our leadership in the field of precision measurement with the development of our own global position system (GPS).



SOKKIA CO.,LTD.

1-1,TOMIGAYA 1-CHOME,SHIBUYA-KU,TOKYO, 151 JAPAN
PHONE +81-3-3465-5211 FAX +81-3-3465-5203
INTERNATIONAL DEPT. PHONE +81-3-3465-5201 FAX +81-3-3465-5202

SOKKIA CORPORATION 9111 Barton, P.O. Box 2934, Overland Park, Kansas, 66201 **U.S.A.**, Phone +1-913-492-4900 Fax +1-913-492-0188
SOKKIA CORPORATION (CANADA) 1050 Stacey Court. Mississauga. Ontario, L4W 2X8 **Canada**, Phone +1-905-238-5810 Fax +1-905-238-9383
SOKKIA CENTRAL & SOUTH AMERICA CORPORATION 1200 N.W.78th Avenue, Suite 109 Miami, Florida,33126 **U.S.A.**, Phone +1-305-599-4701 Fax +1-305-599-4703
AGL CORPORATION 2202 Redmond Road, P.O. Box 189, Jacksonville, Arkansas, 72078 **U.S.A.**, Phone + 1-501-982-4433 Fax + 1-501-982-0880
SOKKIA PTY. LTD. Rydalmere Metro Centre, Unit 29, 38-46 South St., Rydalmere, NSW, 2116 Australia, Phone +61-2-9638-0055 Fax +61-2-9638-3933
SOKKIA WESTERN AUSTRALIA PTY. LTD. (Perth) Unit 2/4 Powell St., Osborn Park, WA,6117 **Australia**, Phone +61-8-9201-0133 Fax +61-8-9201-0205
SOKKIA NEW ZEALAND 20 Constellation Drive, C.P.O. Box 4464, Mairangi Bay, Auckland, 10 Auckland, **New Zealand**, Phone +64-9-479-3064 Fax +64-9-479-3066
SOKKIA B.V. Businesspark De Vaart, Damsluisweg 1, 1332 EA Almere, P. O. Box 1292, 1300 BG Almere, **The Netherlands**, Phone +31-36-53.22.880 Fax +31-36-53.26.241
SOKKIA LTD. Datum House, Electra Way, Crewe Business Park, Crewe, Cheshire, CW1 1 ZT **United Kingdom**, Phone +44-1270-25.05.25 Fax +44-1270-25.05.33
SOKKIA B.V. Niederlassung Deutschland An der Wachsfabrik 25, 50996 Köln (Rodenkirchen), **Germany**, Phone +49-2236-6.40.58 Fax +64-2236-6.26.75
BLINKEN A.S. Postboks 122, Ostkilen 4, N-1620 Gressvik, **Norway**, Phone +47-69-32.90.11 Fax +47-69-32.61.21
SOKKIA spol. s.r.o. Pacovska 31, 140 00 Praha, 4 **Czech Republic**, Phone +42-2-61211372 Fax +42-2-61211194
SOKKIA S.A. 12, Avenue Gabriel Peri, 78360 Montesson, **France**, Phone +33-1-30.53.09.73 Fax +33-1-39.76.63.15
SOKKIA S.R.L. Via Alserio 22,20159 Milano, **Italy**, Phone +39-2-66.803.803 Fax +39-2-66.803.804
SOKKIA N.V./S.A. Sphere Businesspark, Doornveld 1-1A, B-1731 Zellik (Brussels), **Belgium**, Phone +32-2-466.82.30 Fax +32-2-466.83.00
SOKKIA VERTRIEBS GmbH Ottakringerstrafle 54/4.2 A-1170 Wien, **Austria**. Phone +43-1-4025.9020 Fax +43-1-4025.9019
SOKKIA KFT. Legszesgyar U. 17.3.em, 7622 Pecs, **Hungary**, Phone +36-72-324.636 Fax +36-72-324.636
SOKKIA KOREA CO.,LTD. Rm.401, Kwan Seo Bldg, 561-20 Sinsa-dong, Kangnam-ku, Seoul, **Republic of Korea**, Phone + 82-2-514-0491 Fax + 82-2-514-0495
SOKKIA SINGAPORE PTE. LTD. 401 Commonwealth Drive, #06-01 Haw Par Technocentre, 149598 **Singapore**, Phone +65-479-3966 Fax +65-479-4966
SOKKIA (M) SDN. BHD. No.88 Jalan SS 24/2 Taman Megah,47301 Petaling Jaya, Selangor Darul Ehsan, **Malaysia**, Phone +60-3-7052197 Fax +60-3-7054069
SOKKIA HONG KONG CO., LTD. Rm.1406 Shatin Galleria, 18-24 Shan Mei Street FoTan, NewTerritories, **Hong Kong**, Phone +852-2-6910280 Fax +852-2-6930543
SOKKIA PAKISTAN (PVT) LTD. MUGHALIYA Centre, Allama Rashid Turabi Rd., Blk "N" North Nazimabad, Karachi 74700 **Pakistan**, Phone +92-21-6644824 Fax +92-21-6645445
SOKKIA GULF P.O. Box 4801, Dubai, **U.A.E.**, Phone +971-4-690965 Fax +971-4-694487
SOKKIA RSA PTY. LTD. P.O. Box 7998, Hennopsmeer, 0046 **Republic of South Africa**, Phone +27-12-663-7999 Fax +27-12-663-4039
SOKKIA CO.,LTD. SHANGHAI REP. Office 4F Bldg. No.1, 1299 Xinjingiao Road, Pudong J inqiao Export Processing Zone, Shanghai, 201206 **People's Republic of China**, Phone +86-21-58345644 Fax +86-21-58348092

 Sokkia is a sponsor of the International Federation of Surveyors

ISO 9001 Certified



Certificate No. JQA-0557
ISO 9001/BS EN ISO 9001/EN 29001/JIS Z9901

SOKKIA CO.,LTD.